

**SOKKIA**

# **SUPPLIES & ACCESSORIES**

**PRODUCT CATALOG 2016**





# INDEX

Bags & Carrying Cases .....	32	Reflective Targets .....	4
Compass & Clinometers .....	30	Rods	
Field Books .....	24-25	Digital .....	12
Flagging.....	33	NEDO Fiberglass .....	12
Hand Tools .....	36-37	Specialty .....	13
Levels		SK Rod Replacement Pole Sections .....	14
Abney .....	17	Safety & Accessories.....	40-41
Hand.....	16	Specialty Poles	
Markers .....	38	GPS .....	11
Measuring Tapes		Range .....	11
Chaining Pins .....	26	Robotics .....	11
Lufkin .....	26-28	Stereoscopes.....	23
Sokkia/Eslon .....	29	Surveying Markers .....	34
Paint .....	39	Thermometers.....	31
Planimeters .....	15	Tripods & Accessories	
Plumb Bobs .....	35	Tripods .....	18
Prisms, Prism Poles, Accessories		NEDO Tripods.....	19
Accessories .....	9	Tribachs & Adapters.....	22
Bipods & Tripods .....	9	Tripod Parts .....	20-21
Data Collector Brackets .....	9		
Prisms.....	5-6		
Prism Poles.....	8,10		
Specialty Prisms.....	7		

## REFLECTIVE SHEET TARGETS

RS\*\*T 0.3 mm thin, self-adhesive sheets that adhere to almost any surface.

RS\*\*N includes normal (0.5 mm) reticle lines.

210210004	RS00 Target 230 x 230 mm (1 each) (SO)
210210005	RS05T Targets 5 x 5 mm (400 each) (SO)
210210006	RS10N Targets 10 x 10 mm (400 each)
210210009	RS10T Targets 10 x 10 mm (400 each)
210210010	RS15N Targets 15 x 15 mm (196 each) (SO)
210210013	RS15T Targets 15 x 15 mm (196 each) (SO)
210210018-SURSK	RS20N Reflective Sheet Target 20 x 20 mm (0.79 x 0.79 in.) (100/Sheet)
210210019	RS20T Targets 20 x 20 mm (100 each) (SO)
210210026	RS30N Targets 30 x 30 mm (49 each)
210210029	RS30T Targets 30 x 30 mm (49 each) (SO)
210210035-SURSK	RS50N Reflective Sheet Targets 50 x 50 mm (1.96 x 1.96 in.) (16/sheet)
210210037-SURSK	RS70N Reflective Sheet Targets 70 x 70 mm (2.75 x 2.75 in.) (9/sheet)
210210040	RS90N-K Targets 90 x 90 mm (4 each) (SO)
210210041-SURSK	RS90N Reflective Sheet Targets 90 x 90 mm (3.54 x 3.54 in.) (4/sheet)

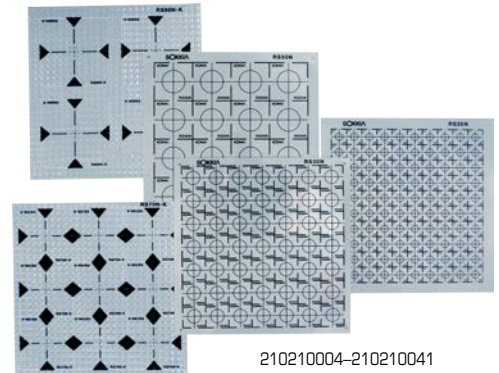

210210004-210210041

## SPECIALTY TARGETS

Easy-to-use reflective targets supplied on adhesive-backed sheets; can be directly affixed to measuring points. For alternative needs, rotary targets and a 2-point target are also available.

210210046	RT50M Magnetic Target
634412	RT90M Rotary Target (SO)
210210045	RT50G10 Rotary Target (SO)
210210049	RT90G10 Rotary Target (SO)
210210002	RC50 Reflective Target 73 x 73mm (SO)
210210187	2RT500 Reflective Target Set
210160218	RTSO S-K Pin-Pole Reflective Target



210210046

634412

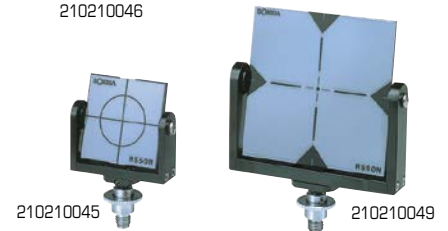

210210045

210210049

## DETACHABLE ROTARY TARGET

The RT90C can be mounted on a tribrach with the AP41 adapter or mounted directly to prism pole.

210160170	RT90C 360° Rotating Sheet Target
-----------	----------------------------------

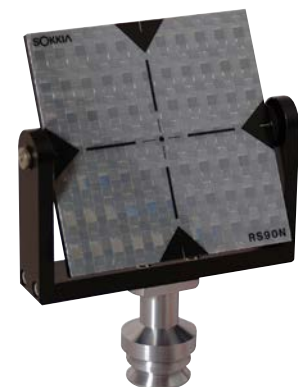



726132  
Shown with AP01-AR and AP11, AP11T

### ADVANCED PRISM SYSTEMS (AP SERIES) 40MM

726132	AP11A Single Tilting Assembly Complete
210160013	AP32 Triple Tilting Mount
210160005	AP11 Single Tilting Mount
210160001	AP01 Prism -40 mm
210160003	AP01S -30 mm Adapter
210160006	AP11T Target
210160186	AP01-AR Prism System -30 mm offset (includes AP01 Prism and AP01S Adapter)
210165200	Sokkia AP Traverse Kit – Kit includes TR-101 Tribrach, AP41 Adapter, AP01-AR Kit, Carrying case. This is for 'leap frog' traverse method in which tribrachs may be left in place.



210160005



210160013



726669



726668

### STANDARD -30 MM PRISM SYSTEMS

726668	Single Prism 0/30 mm Target with Mount
726669	62mm Prism System with Metal Canister

Prism mounts are made of all metal with a locking screw for tilting the prism.

724803	Single Tilting Mount Transit Base
724806	Tilting Prism Assembly

### ROBOTIC PRISMS

1004684-01-SURSK	Builder Series 360° Prism
------------------	---------------------------



### SINGLE PRISMS

These prisms are compatible with the Builder Series Standard Prism Systems

62 mm Prism Plastic Canisters are available in two styles and colors:

724801	Prism 62 mm Silver Coated Water Sealed
724802	Economy Prism 62 mm Silver Coated
724813	Economy Prism 62 mm Copper Coated



### REAR LOCKING BUILDER SERIES 6 X 9

This prism assembly allows the user to quickly adjust the tilting target from behind the prism as it is pointing at the instrument to allow accurate sighting. The targets are 6 x 9 in. and available in either florescent orange or yellow. The prism can be either mounted in a 0 or -30 mm offset position. All come with a protective carry case for the target or complete system.

724809	Tilting Prism Mount with 6 x 9 in. Target Florescent Orange
724810	Tilting Prism Mount with 6 x 9 in. Target Florescent Yellow



These complete prism systems come with a 62 mm copper-coated prism in a sealed canister.

724811	Tilting Prism Assembly with 6 x 9 in. Target, Florescent Orange (Copper Coated Prism)
724812	Tilting Prism Assembly with 6 x 9 in. Target, Florescent Yellow (Copper Coated Prism)



### REAR LOCKING BUILDER SERIES - 5.5 X 7

This prism assembly allows the user to quickly adjust the tilting target from behind the prism as it is pointing to the instrument to allow accurate sighting. The targets are 5½ x 7 in. and are available in either florescent orange or yellow. The prism can be either mounted in a 0 or -30 mm offset position. All come with a protective carry case for the target or complete system.

724804	Economy Single Tilting Prism Mount with 5½ x 7 in. Target Florescent Orange
724805	Economy Single Tilting Prism Mount with 5½ x 7 in. Target Florescent Yellow



The complete prism systems come with a 62 mm silver-coated prism in a sealed canister. Both come in a protective carry case.

60857-SURSK	Economy Tilting Prism Assembly with 5.5 x 7 in. Target, Florescent Orange
724808	Economy Tilting Prism Assembly with 5.5 x 7 in. Target, Florescent Yellow





724100

### STROBE PRISM ASSEMBLY

62 mm Strobe Prism Assembly with a 5½ x 7 in. or 6 x 9 in. florescent orange target. The prism can be either mounted in a 0 or -30 mm offset position. It works perfectly in low light conditions and all the electronics are housed in the prism canister. The battery is a Sanyo CR-1/3N; good for over 20 hours of use. Comes with a protective carry case for the target or complete system.

724100	Strobe Prism Assembly with 5½ x 7 in. Target
724101	Strobe Prism Assembly with 6 x 9 in. Target



### P2A SERIES 25.4 MM MINI PRISM ASSEMBLY

- Precision ground to 5 arc second accuracy
- All metal, high quality construction
- Prism is silver coated with a hard epoxy overcoat to protect against moisture and severe climatic conditions
- 40 minute vial bubble level side-mounted
- The prism can be either mounted in a 0 or -30 mm offset position
- High quality laser engraved manufactured from aircraft grade 6061-T6 billet aluminum
- All parts are anodized for long lasting durability
- Brass Pointed Ears works are vertical line target arrows
- Kit includes prism assembly, mini plumb line bracket, mini plumb bob, and durable carrying case

726862	P2A Peanut Prism Assembly
--------	---------------------------



724861

724862

### BUILDER SERIES MINI PRISMS

System contains a copper coated 25 mm prism, a tilting holder that has either a side-mounted or center vial. The prism can be either mounted in a 0 or -30 mm offset position. Kit comes with two adapters, plumb bob holder and padded carrying case with a belt loop.

724861	Mini Prism System with Non-Adjustable Center vial
724862	Mini Prism System with Non-Adjustable Side Vial



### PIN POLE WITH SLIDING 25 MM PRISM SYSTEM

System includes a 25 mm silver coated prism, three 60 cm length pole sections – in red and white 10 cm stripes (total length is 1.8 m/5.9 ft.). The prism can be mounted in a 0 mm offset position. The kit also comes with a padded carrying case and a plumb bob hook, and cap for prism to use as an offset prism by itself.

724870	Mini Prism System Kit with Pin Pole
--------	-------------------------------------



### MONITORING PRISM

25 mm specialty prism that can be mounted to a range of different surfaces and used in many different environments.

724814	90° L-Bar Monitoring Prism
--------	----------------------------

### COMPRESSION/COLLET LOCK PRISM POLES

The Sokkia compression lock prism pole offers a secure locking system with a polished aluminum pole with a brass lock. The pole is red and white offered in three sizes with an adjustable tip and dual graduations. Also included with each pole is a carrying case.

51780-SURSK	8.5 ft. Compression Lock Prism Pole – Adjustable Tip (Dual Graduations)
724207	12 ft. Compression Lock Prism Pole – Adjustable Tip (Dual Graduations)
724208	15 ft. Compression Lock Prism Pole – Adjustable Tip (Dual Graduations)

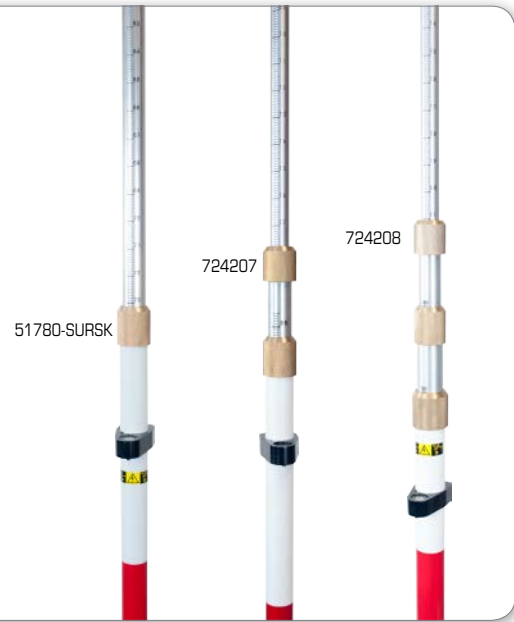

### SOKKIA KNOB-LOCK PRISM POLES

The Sokkia knob-lock prism pole is easy to tighten and release with its large adjustable knob. The pole is red and white offered in three sizes with an adjustable tip and dual graduations. Also included with each pole is a carrying case.

724200	8.5 ft. Knob Lock Prism Pole – Adjustable Tip (Dual Graduations)
724201	12 ft. Knob Lock Prism Pole – Adjustable Tip (Dual Graduations)
724202	15 ft. Knob Lock Prism Pole – Adjustable Tip (Dual Graduations)

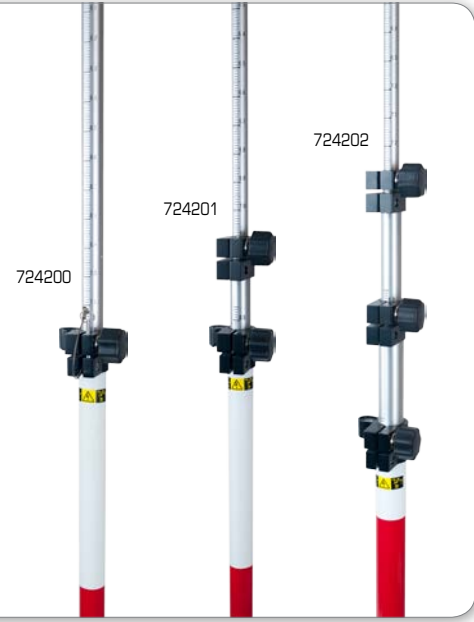

### SOKKIA QUICK-RELEASE PRISM POLES

The Sokkia quick-release handle lock prism pole allows for quick adjustments to prism heights. The pole is red and white offered in three sizes with an adjustable tip and dual graduations. Also included with each pole is a carrying case.

51773-SURSK	8.5 ft. Quick Release Lever Lock Prism Pole – Adjustable Tip (Dual Graduations)
724204	12 ft. Quick Release Lever Lock Prism Pole – Adjustable Tip (Dual Graduations)
724205	15 ft. Quick Release Lever Lock Prism Pole – Adjustable Tip (Dual Graduations)







### BUILDER SERIES BIPOD AND TRIPOD

Builder series bipod and tripod assembly is designed for quick setup and field durability. These models are come with a carrying case to protect them. The bipods also have a bipod leg clip included as well.

724897	Economy Prism Pole Bipod Red
724898	Economy Mini Prism Pole Bipod Red
1009273-01	Carbon Fiber Prism Pole Bipod (Sokkia)

### PRISM POLE ACCESSORIES

808850	Universal Replacement Point (Prism Pole, Bipod & Range Pole)
808851	Topographic Shoe Regular
808852	Topographic Shoe Wide Base
808853	5/8 x 11 Adjustable Precise Tip - Fine (Compatible with Pro Series and Robotic Poles)



### MINI STAKE-OUT POLES

Available in Economy or Pro-Series. Measures 1.29 ft. (15 in.) with point (1 ft. rod section).

724242	Economy Mini Stake-Out Pole Red with Carrying Bag
808042	Mini Stake-Out Pole Red (no carrying case)
808043	5.1 ft. / 2.7 m Pro Series Aluminum Knob Lock Mini Pole



### DATA COLLECTOR BRACKETS

- Pro Series Crush Proof 1.25 in. Pole Claw Clamp with Pro Series Cradle
- Crush proof style pole clamp and cradle with a push button quick release
  - 1.25 in. pole clamp capacity
  - 20 different angles snap-in adjustment with 2 hardened stainless steel lock pins
  - Anti-slip diamond knurled lock knobs
  - Constructed of aircraft grade 6061-T6 billet aluminum
  - Black anodize finish with high tech laser engraving
  - Made in the USA

552072	Allegro / Explorer / JETTce Tripod Hook Bracket
808152	Claw Clamp & Cradle for Allegro/Explorer
808153	Claw Clamp & Cradle for Archer/MINI
808154	Claw Clamp & Cradle for SHC25/SHC25A
808155	Claw Clamp & Cradle for SHC2500
808156	Claw Clamp & Cradle for SHC250
808158	Claw Clamp & Cradle for SHC236/336
808160	Pole Clamp, Quick Release with Vial & Compass
808161	Pole Clamp, Quick Release Plain
808162	Cradle, Quick Release for SHC2500/FC-2500
808163	Cradle, Quick Release for Ranger & TSC2
808164	Cradle, Quick Release for Allegro/Explorer
808165	Cradle, Quick Release for Surveyor+
808166	Cradle, Quick Release for FC-200/FC-250
808167	Cradle, Quick Release for Nomad
808168	Cradle, Quick Release for SHC236
808169	Cradle, Quick Release for TSC3 & Ranger 3
1000183-01-SURSK	4 Screw Pole Mount Bracket for Mesa

### PRO SERIES LEVER LOCK PRISM POLES

- User friendly lever lock mechanism
- One hand operation
- Precision CNC marked graduations won't fade or rub off
- Heavy duty aluminum construction with electrostatic epoxy powder coat finish
- 40 minute top-adjust vial bubble level
- Fine threaded precise tip allows for precision height adjustment
- Stainless steel tip points, ultra light weight corrosion resistant hybrid design
- Available in red/white bands
- Lightweight

727066	8.5 ft. Pro Series Aluminum Lever Lock Prism Pole, Dual Graduations
--------	---



### PRO SERIES KNOB LOCK PRISM POLES

- User friendly lever lock mechanism
- One hand operation
- Slip resistant molded rubber knob
- Precision CNC marked graduations won't fade or rub off
- Heavy duty aluminum construction with electrostatic epoxy powder coat finish
- 40 minute top-adjust vial bubble level
- Fine threaded precise tip allows for precision height adjustment
- Stainless steel tip points, ultra light weight corrosion resistant hybrid design
- Available in red/white bands
- Lightweight

808200	8.5 ft. Pro Series Aluminum Knob Lock Prism Pole, Dual Graduations
808201	12 ft. Pro Series Aluminum Knob Lock Prism Pole, Dual Graduations
808202	15 ft. Pro Series Aluminum Knob Lock Prism Pole, Dual Graduations
808204	3.6 m Pro Series Aluminum Knob Lock Prism Pole, Metric



### PRO SERIES BIPODS & TRIPOD

- Original quick snap bipod & tripod assembly with dual push button thumb release for rapid level adjustment
- Quick Closure Pole Lock Mechanism allows fast attachments
- Accepts pole diameters of 0.75 to 1.5 in. (19 - 38 mm)
- Quickly and effortlessly convert to a tripod by adding an optional 3rd leg
- Simple few additional twist of lock knob to secure pole to bipod
- Wide stance pivot tang to improve stability by distributing center of mass
- All metal CNC construction
- Stainless steel lightweight points included
- Manufactured from aircraft grade 6061-T6 billet anodized aluminum, stainless steel and brass

808896	Pro Series Prism Pole Thumb Release Tripod – Red
808897	Pro Series Prism Pole Thumb Release Bipod – Red
808898	Pro Series Mini Prism Pole Thumb Release Bipod – Red





### ROBOTIC POLES

The Sokkia robotic poles all feature all of the benefits of the “Pro Series” line of product. The poles are available in both aluminum and carbon fiber. The robotic poles have a D-shape pole to keep it from twisting and always aligned for use with the RC unit. 727071 is the standard Robotic Prism Pole sold with the RC-PR5/SX system.

727070	12 ft. Aluminum Prism Pole for RC-PR3 (Dual Grads - Feet / Tenths & Metric)
727071	8 ft. Aluminum Lever Lock Prism Pole for RC-PR4/5, Feet
727074	8 ft. Carbon Fiber Lever Lock Prism Pole for RC-PR4/5, Feet
727075	8.5 ft. Carbon Fiber Lever Lock Prism Pole for RC-PR4/5, Meters



### GPS POLES

The Sokkia GPS pole lineup features a wide variety of styles. Choose from adjustable height to 2 m fixed height. Also available is a pole with anti-crush feature, so your data collector clamp will not compromise the pole. The 808016 is the pole that comes with GRX2 and GHX2 systems standard.

808015	2.5 m GPS Adjustable Rover Pole, Knob Lock – Dual Graduations
808016	2 m GRX1/GRX2 Rover Pole, Carbon Fiber, 2 section
808017	Snap Lock GPS Pole, Carbon Fiber
808018	2 m Snap Lock GPS Rover Rod
808019	2 m Snap Lock GPS Rover Rod, Aluminum
808090	2 m GPS Anti-Crush Aluminum Rover Rod, 2 Section - Sokkia Green
724290	2 m Economy GPS Aluminum Rover Rod, 2 Section - Sokkia Green with carrying case
724291	2 m Economy GPS Carbon Fiber Rover Rod, 2 Section with carrying case



### GPS POLE ACCESSORIES

Quick Release assembly for removal of GNSS receivers or antennas. Uses 5/8 x 11 in. threading, compatible with nearly every GNSS product.

808047	GPS Quick Release Assembly (top and bottom)
808048	GPS Quick Release Top (antenna mount)
808049	GPS Quick Release Bottom (pole mount)

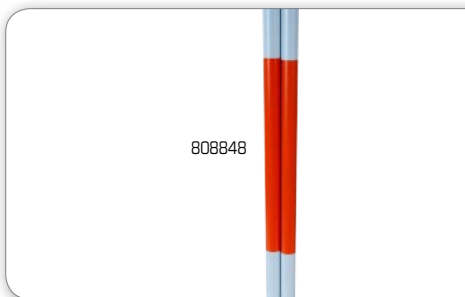

### HEAVY-DUTY RANGE POLES

Alternating 12 in color sections orange and white.

808849	4 ft. Range Pole Section
808848	8 ft. Range Pole 2 Sections with Point
808847	12 ft. Range Pole 3 Sections with Point



### POLE PEG ADJUSTING JIG

This simple bracket allows you to adjust and calibrate pole vials in your office. The adjusting jig features a simple L-bracket to set the pole point into and a knob adjusting top to center the pole vial prior to adjusting the bubble.

724301	Pole Peg Adjusting Jig
--------	------------------------

### SOKKIA SK LEVEL RODS

- Unique patented oval shape permits equal size graduations full-length, prevents rod from rolling and is easier to hold
- Numerals and graduations are epoxy-protected for maximum wear-resistance and sized for maximum readability
- Sections cushioned with glides to prevent wear
- Linear accuracy exceeds 1 in 4,000
- Made from strong, corrosion-proof fiberglass that is lightweight and won't warp or swell
- Rods have height measuring gauge on back side except for 807368 or 807349
- Female threaded hole (5/8 x 11 in.) on top for mini-prism
- Made from non-conductive materials

807344	18 ft. SK Rod, 5 sections, ft. / 10ths
807338	25 ft. SK Rod, 7 sections, ft. / in.
807348-SURSK	25 ft. SK Rod, 7 sections, ft. / 10ths
807368	25 ft. / 7 m in length, 7 sections, meters/decimeters / ½ centimeters & ft. / 10ths / 100ths
807349	32 ft. in length, 9 sections, ft. / 10ths / 100ths with attached footplate

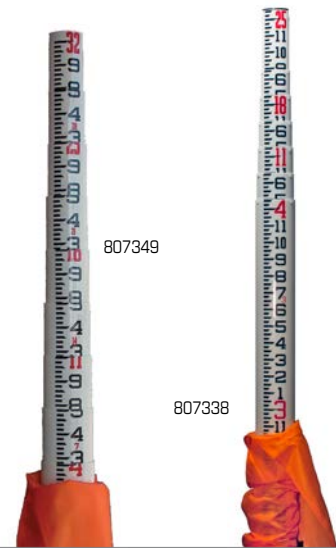

### NEDO® FIBERGLASS LEVELLING RODS

- Extremely robust design with Anti-Jam® buttons made of brass ensure a long life
- High precision scale on front and back
- Scale on back allowing for overall height readings
- Ergonomically designed shape for a better grip
- Non-conductive under dry conditions
- Laser receiver brackets are easily attached
- Free carrying bag and snap-on rod level included
- Made in Germany

809109	3 m Fiberglass Leveling Rod, 3 sections, m/cm/5 mm
809102	13 ft. Fiberglass Leveling Rod, 3 sections, ft/10/100
809106	13 ft. Fiberglass Leveling Rod, 3 sections, ft/in/8th
809110	4 m Fiberglass Leveling Rod, 3 sections, m/cm/5 mm
809103	16 ft. Fiberglass Leveling Rod, 3 sections, ft/10/100
809107	16 ft. Fiberglass Leveling Rod, 3 sections, ft/in/8th
809111	5 m Fiberglass Leveling Rod, 3 sections, m/cm/5 mm
809104	25 ft. Fiberglass Leveling Rod, 3 sections, ft/10/100
809112	7.6 m Fiberglass Leveling Rod, 3 sections, m/cm/5 mm

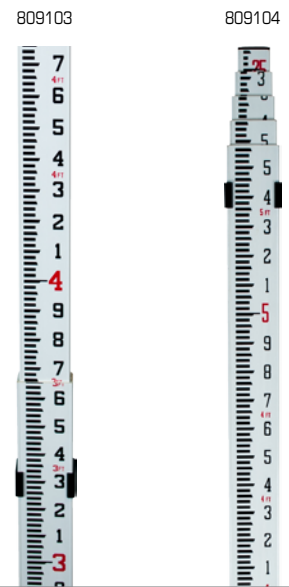

### SDL DIGITAL LEVEL RODS

Sokkia's RAB-Code (RANdom BiDirectional Code) staffs are designed exclusively for use with Sokkia Digital Levels. Staffs are available in Invar, fiberglass and aluminum in various lengths.

738037	BIS30A New Super Invar RAB-code Staff (SO)
210154100	BIS20 2 m Invar Staff Set for SDL30 (Two Rods with Case) (SO)
210154200	BIS20 3 m Invar Staff Set for SDL30 (Two Rods with Case) (SO)
210154300	BGS30 4 m Barcode Staff with Case (metric grads on back)
210154400	BGS40 4 m Barcode Staff with Case (metric grads on back)
210154500	BGS50 5 m Barcode Staff with Case (metric grads on back)
210154510	BGS50G3 16 ft. Barcode Staff with Case (ft/10th on back)
210160222	BSS60 60 cm Steel Barcode Section with Case (SO)
210164300	BAS55 Aluminum Barcode Staff 5 m with Case
210150031	GS20L Circular Level for BGS Rod, 20"
210150032	GS60L Circular Level for BGS Rod, 60"/2 mm with Case
809601	Base Plate (Turtle)



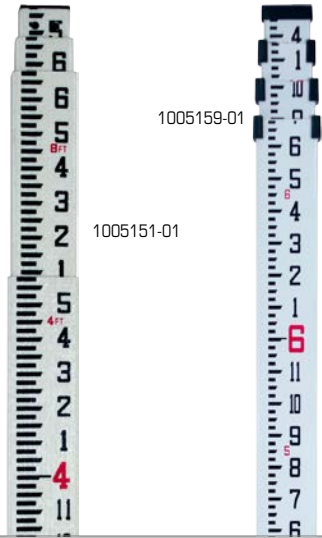

### BUILDER SERIES LEVEL RODS

#### Fiberglass Rods

1005149-01	13 ft. Builder Fiberglass Rod, Inches
1005150-01	13 ft. Builder Fiberglass Rod, tenths
1005151-01	16 ft. Builder Fiberglass Rod, Inches
1005152-01	16 ft. Builder Fiberglass Rod, tenths
1005153-01	20 ft. Builder Fiberglass Rod, Inches
1005154-01	20 ft. Builder Fiberglass Rod, tenths
1005155-01	25 ft. Builder Fiberglass Rod, Inches
1005156-01	25 ft. Builder Fiberglass Rod, tenths

#### Aluminum Rods

1005157-01	13 ft. Builder Aluminum Rod, Inches
1005158-01	13 ft. Builder Aluminum Rod, tenths
1005159-01	16 ft. Builder Aluminum Rod, Inches
1005160-01	16 ft. Builder Aluminum Rod, tenths



### DIRECT ELEVATION RODS

- Made of high strength clear anodized aluminum for lightweight, rugged, dependable operation. They will not rust, split, splinter, swell or warp in any environment.
- Heavy duty, High Visibility tape
- Solid tape lock with internal brake slide

807650	Direct Elevation Rod, ft./10ths, 10 ft.
807651	Direct Elevation Rod, ft./in., (SO)
807652	Direct Reading Rod 3 m (SO)
807653	Replacement Tape 10 ft., 10ths (SO)
1001605-01	Rod, 10' Laser Rod 10ths plus cut/fill
1001607-01	Rod, 15' Laser Rod 10ths
1001991-01	Direct Reading Rod 10' 10ths with receiver guide



### SOKKIA/SK MEASURING POLES

- Exact measurements of up to 26 ft. or 8 m can be read on the enclosed, sealed digital readout
- Rugged fiberglass construction with excellent tensile strength
- Smooth telescoping movement with friction clamps
- Only 4 ft. 8 in. closed and less than 5 lbs.
- Linear accuracy exceeds 1 in 2,000

807376	Graduated in ft./in./8ths
807386	Graduated in ft./10ths/100ths
807396	Graduated in m/dm/cm/mm



### ROD LEVEL

Determines if the level rod is perpendicular. Head is adjustable so that a true level can be maintained.

724190	Rod Level
--------	-----------

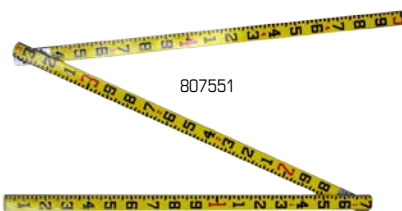

### BUILDER'S MINI ROD

Wooden rod unfolds to 6½ ft. or 9½ ft. Printed graduations on both sides are embedded below the surface and sealed.

807548	6½ ft. Mini Rod, ft./10ths/100ths
807551	9½ ft. Mini Rod, ft./10ths/100ths

**18 FT. SK LEVEL ROD FT/INCH WITH CASE**

807334	18 ft. SK Rod, ft./inch with Case
8073-341	SK205, 18F, inches, bottom 0-4
8073-342	SK205, 18F, inches, second 4-7.5
8073-343	SK205, 18F, inches, third 7.5-11
8073-344	SK205, 18F, inches, fourth 11-14.5
8073-345	SK205, 18F, inches, fifth 14.5-18

**18 FT. SK LEVEL ROD FT/10THS WITH CASE**

807344	18 ft. SK Level Rod ft./10ths with Case
8073-441	SK205, 18F, tenths, bottom 0-4
8073-442	SK205, 18F, tenths, second 4-7.5
8073-443	SK205, 18F, tenths, third 7.5-11
8073-444	SK205, 18F, tenths, fourth 11-14.5
8073-445	SK205, 18F, tenths, fifth 14.5-18

**25 FT. SK LEVEL ROD FT/INCH WITH CASE**

807338	25 ft. SK Rod, ft./inch with Case
8073-381	SK205, 25F, inches, bottom 0-4
8073-382	SK205, 25F, inches, second 4-7.5
8073-383	SK205, 25F, inches, third 7.5-11
8073-384	SK205, 25F, inches, fourth 11-14.5
8073-385	SK205, 25F, inches, fifth 14.5-18
8073-386	SK205, 25F, inches, sixth 18-21.5

**25 FT. SK LEVEL ROD FT/10THS WITH CASE**

807348	25 ft. SK Rod, ft./10ths with Case
8073-481	SK205, 25F, tenths, bottom 0-4
8073-482	SK205, 25F, tenths, second 4-7.5
8073-483	SK205, 25F, tenths, third 7.5-11
8073-484	SK205, 25F, tenths, fourth 11-14.5
8073-485	SK205, 25F, tenths, fifth 14.5-18
8073-486	SK205, 25F, tenths, sixth 18-21.5

**25 FT. SK LEVEL ROD 10THS/METRIC WITH CASE**

807368	25 ft. SK Rod, 10ths/metric with Case
8073-681	SK205, 25F, tenths/metric, bottom 0-4
8073-682	SK205, 25F, tenths/metric, second 4-7.5
8073-683	SK205, 25F, tenths/metric, third 7.5-11
8073-684	SK205, 25F, tenths/metric, fourth 11-14.5
8073-685	SK205, 25F, tenths/metric, fifth 14.5-18
8073-686	SK205, 25F, tenths/metric, sixth 18-21.5
8073-687	SK205, 25F, tenths/metric, seventh 21.5-25

### 32 FT. SK LEVEL ROD FT./10THS WITH CASE

807349	32 ft. SK Level Rod ft./10ths with Case
8073-491	SK205, 32F, tenths, bottom 0-4
8073-492	SK205, 32F, tenths, second 4-7.5
8073-493	SK205, 32F, tenths, third 7.5-11
8073-494	SK205, 32F, tenths, fourth 11-14.5
8073-495	SK205, 32F, tenths, fifth 14.5-18
8073-496	SK205, 32F, tenths, sixth 18-21.5
8073-497	SK205, 32F, tenths, seventh 21.5-25
8073-498	SK205, 32F, tenths, eighth 25-28.5
8073-499	SK205, 32F, tenths, ninth 28.5-32

### PLANIMETERS

365151	Planix 5 Electronic Polar Compensator Planimeter
365161	Planix 6 Electronic Compensator Roller Planimeter
365170	Planix 7 Electronic Compensator Roller Planimeter
365110	Planix 10S Marble Digitizing Area Line Meter

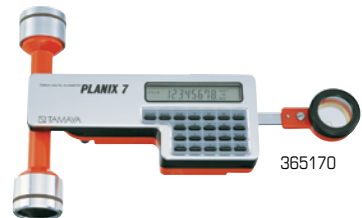

**HAND LEVEL – 1X**

Fixed eyepiece; internally mounted bubble assembly and adjustable reflector.  
Six inches in length with durable finish.

804350	1x Hand Level with Bubble Inside
804908	Replacement Case



804350

**MAGNIFYING HAND LEVEL – 5X**

Provides accuracy at greater distances. Objective lens and eyepiece slide for easy focusing.  
Stadia lines with 1:100 ratio. Length of 7½ in. Padded belt loop case included.

804260	5x Magnifying Stadia Hand Level
804907	Replacement Case



804260

**SQUARE-TYPE HAND LEVEL – 1X**

Fixed eyepiece; internally mounted bubble assembly and adjustable reflector. 6 in.  
in length with durable finish.

804520	Square-Type Hand Level
804912	Replacement Case



804520



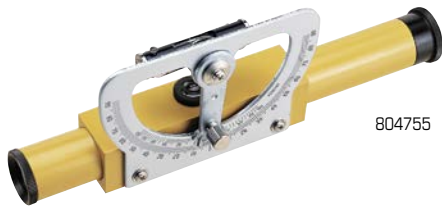

804755

### MAGNIFYING ABNEY LEVEL WITH STADIA – 5X

Percent scale in both directions easy-slide focusing motions for objective and eyepiece. 1:100 stadia. Enamel finished 7¾ in. barrel extends to 8 5/8 in. Measure existing grades with the 1 x 3¾ in. flat base. Padded belt-loopcase included.

804755 Magnifying Abney Level with Stadia

804911 Replacement Case



804710

### ABNEY LEVEL WITH CLINOMETER

Tube is 5 1/8 in. long. Radius arc of 1 1/8 in. graduated in degrees (0-90°) in both directions; vernier reading of 10 minutes. Slope scale 1:1 and 1:10. Padded belt-loop case included.

804710 5" Arc, Degree and Slope Abney Level

804715 5" Arc, Percent and Degree Abney Level

804905 Replacement Case



804745

### TOPOGRAPHIC ABNEY LEVEL

Two interchangeable arcs offer chainage correction, degrees (0-60°) in both directions and percent of grade. Index has friction movement for fine adjustment. Non-glare 6 3/8 in. aluminum level tube extends to 7 3/8 in. Padded belt-loop case included.

804745 6 3/8 in. Top with Two Arcs Abney Level

804907 Replacement Case



### DOUBLE RIGHT ANGLE PRISM

Two prisms allow for sight to the right and left. Clear optical glass for straight ahead viewing. Metal construction. Includes leather case.

724780 Double Right Angle Prism

### BUILDER'S SERIES TRIPODS

724445	Aluminum Tripod Light Weight Quick Clamp Height: 34" min / 63" max / 30" closed	5/8 x 11 Head
724645	Aluminum Tripod Medium Weight Quick Clamp Height: 38" min / 63" max / 42" closed	5/8 x 11 Head
724647	Domed Medium Weight Aluminum Tripod Height: 38" min / 63" max / 42" closed	5/8 x 11 Head
724675	Aluminum Tripod Medium Weight Twist Lock Height: 42" min / 70" max / 45" closed	5/8 x 11 Head
724676	Aluminum Tripod Medium Weight Twist Lock (Black) Height: 42" min / 70" max / 45" closed	5/8 x 11 Head
724251	Fiberglass Tripod with Dual Clamp Height: 42" min / 70" max / 45" closed	5/8 x 11 Head
724252	Wood Tripod Dual Clamp with Tool Kit Height: 42" min / 70" max / 45" closed	5/8 x 11 Head
724281	Wood Fiberglass Tripod Twist Lock Height: 38" min / 63" max / 42" closed	5/8 x 11 Head
724282	Wood Fiberglass Tripod Quick Clamp Height: 38" min / 63" max / 42" closed	5/8 x 11 Head



### PROFESSIONAL SERIES TRIPODS

All North American maple with metal hardware (no plastic). The hinges are self-adjusting and it has durable nylon bushings for smooth operation. Tripod shoes have large spurs; hardened steel replaceable tips. Carrying handle.

751252	Sokkia Wide-Frame Wood Tripods (Yellow) Height: 72" max / 45.75" closed	Weight: 14.5 lbs.	5/8 x 11 Flat Head
--------	--	-------------------	--------------------



### SOKKIA WIDE-FRAME ALUMINUM TRIPOD

Anodized finish in high-visibility International orange and silver with sling strap for easy hand or shoulder carrying. Extra-long shoes with large spurs for greater anchoring power. Hardened steel with a screw-clamp leg assembly.

1005306-01	PFA2 Aluminum Tripod, Flat Height: 67" max / 41" closed	Weight: 8.6 lbs.	5/8 x 11 Flat Head
------------	--	------------------	--------------------



### NEDO® SURVEYORS' GRADE WOODEN TRIPODS



- Big round tripod head for easy instrument set-up (approximately 6 ½ in. diameter)
- Plastic coated wooden legs ensure a long life
- Available with Quick Clamp, Screw Clamp or both
- Brass hinge pins for extra stability
- Replaceable points made of hardened steel
- Snap Cap to protect tripod head
- Carrying strap for easy handling

809500	Surveyors Grade Wooden Tripod with Quick Clamp	
809501	Surveyors Grade Wooden Tripod with Dual Clamp	
	Height: 40" min / 66" max / 44" closed	Weight: 17 lbs.
809502	Surveyors Grade Wooden Tripod with Screw Clamp	
	Height: 40" min / 66" max / 44" closed	Weight: 17 lbs.
809503	Surveyors Grade Wood Fiberglass Tripod	

### ELEVATING TRIPODS



- Robust aluminum top plate with 5/8 x 11
- Double telescope for a large working range
- Anodized scale
- Robust crank mechanism for easy handling
- Built-in bubble for easy setup
- Slip-Guard to prevent the legs from spreading unintentionally
- Break-proof aluminum quick release levers

809550	Medium Duty Elevating Tripod	
	Height: 44" min / 93" max / 48" closed	Weight: 12 lbs.
809551	Heavy Duty Elevating Tripod	
	Height: 34" min / 112" max / 44" closed	Weight: 15 lbs.
60810-SURSK	Extra Heavy Duty Elevating Tripod	
	Height: 33" min / 119" max / 52" closed	Weight: 19 lbs.

### TRIPOD STABILIZER



Designed to provide stability when working indoors on concrete and other hard surfaces. Made of heavy-duty aluminum and collapses for compact storage. Comes with rubber O-rings that fit over the feet of the tripod for extra security.

808903	Tripod Stabilizer
--------	-------------------

**TRIPOD PARTS - ALUMINUM BUILDER SERIES (724645, 724445)**

724445-29	724445 Strap assembly (Illustration 29)
724445-30	724445-30724445 Quick release assembly (Illustration 21-28)
724445-31	724445 Leg assembly (Illustration 9-15)
724445-32	724445 Tripod head assembly (Illustration 1-8)
724445-33	724445 Tripod foot assembly (Illustration 16-20)
724645-2	Tripod head
724645-22	Tripod shoe #22
724645-23	Tripod shoe nail
724645-29	Clamp lever rf 724645-45 assembly
724645-3	Centering guide #3
724645-32	724645 Strap assembly (Illustration 32)
724645-4	Centering bolt #4
724645-45	724645 Quick release assembly (Illustration 24-31)
724645-46	724645 Leg assembly (Illustration 9-18)
724645-48	724645 Tripod head assembly (Illustration 1-8, 33)
724645-50	724645 Tripod foot assembly (Illustration 19-23)
724645-HINGE	Hinge bracket

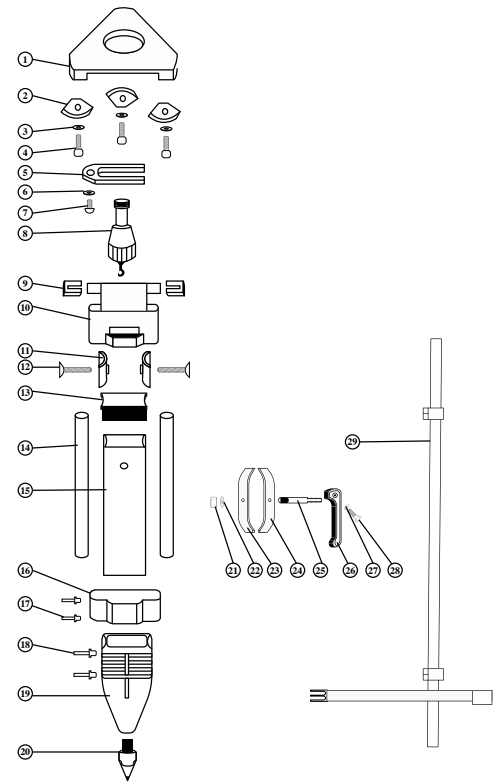

**TRIPOD PARTS - FIBERGLASS (724251, 724252)**

724251-10	Hinge bracket
724251-22	Leg dowel cap
724251-25	Nut
724251-36	Clamp shaft
724251-38	E ring
724251-39	Lever axis
724251-9	Hinge bushing
724252-22	Clamp band
724252-24	Tripod shoe nail
724252-25	Tripod shoe
724252-36	724252 Strap assembly (Illustration 36)
724252-37	724252 Quick release assembly (Illustration 37-1 - 37-8)
724252-46	724252 Leg assembly (Illustration 8-21, 30-32)
724252-48	724252 Tripod head assembly (Illustration 1-7, 33-35)
724252-50	724252 Tripod foot assembly (Illustration 22-29)
724252-8	Hinge bushing
724252-9	Hinge bracket
724252-CLAMP	Complete quick clamp assembly

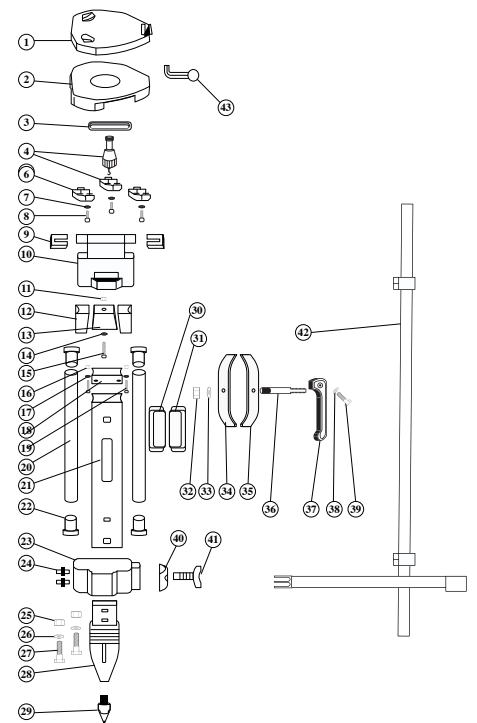

**TRIPOD PARTS - WOOD FIBERGLASS (724281, 724282)**

724282-38	Strap assembly (Illustration 38)
724282-45	Quick release assembly (Illustration 30-37)
724282-46	Leg assembly (Illustration 10-22, 24, 29, 39, 41)
724282-47	Leg assembly with handle (Illustration 10-21, 24, 29, 39, 40, 41)
724282-48	Tripod head assembly (Illustration 1-9)
724282-50	Tripod foot assembly (Illustration 23, 25-28)

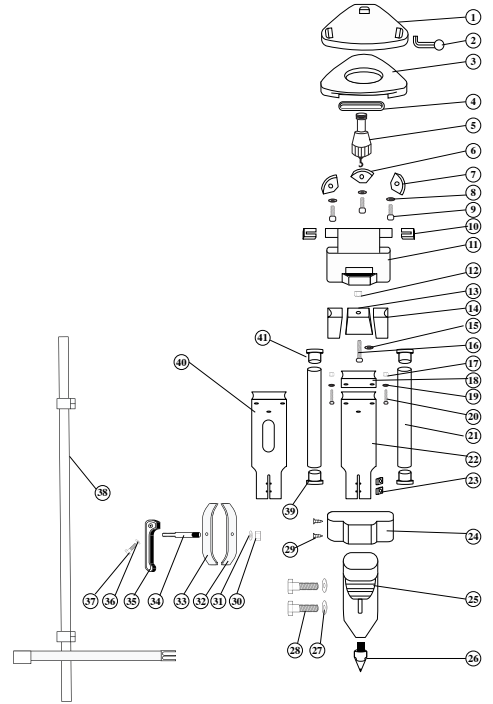

## PRECISION TRIBRACHS

Tribrachs accept Sokkia EDM systems, electronic and optical theodolites, as well as equipment and accessories. Base plate has standard 5/8 x 11 threads and circular level vial with a sensitivity of 10 min./2 mm push-pull slide focus.

307486007-SURSK	TR-102 For manual TS and GPS
307796006-SURSK	TR-111 For motorized TS with optical plummet
307796007-SURSK	TR-112 For manual TS with optical plummet
307486006-SURSK	TR-101 For motorized TS without optical plummet



## LASER TRIBRACH

Bright focused laser dot provides accurate and quick positioning over a point. Push button on/off switch with standard 8 minute circular vial. Includes standard 3 volt CR2 lithium battery.

724034	Tribrach with Laser Plummet, Black
--------	------------------------------------



## BUILDER SERIES TRIBRACHS

22-006008-01	Tribrach with Optical Plummet, Black
22-006008-01-SURSK	Tribrach without Plummet, Black



## TRIBRACH ADAPTERS

Adapter accepts all mount and target assemblies; has 60 second level vial for accurate leveling and centering that's adjustable to match height of optical axis above the tribrach.

22-006009-01-GPSSK	Tribrach Adapter Fixed
--------------------	------------------------

Adapts GPS, prisms and target systems to most tribrachs – has removable center plug with 5/8 x 11 threads and locking screw. Removable center available as a replacement separately.

51842-SURSK	Tribrach Adapter with removable center
-------------	--

Includes 5/8 x 11 male thread for attaching GPS, prisms and target systems. Threaded portion attached to rotating plate for easy aiming. Plate has knurled edge and friction stop.

724042	Tribrach Adapter friction rotatable
--------	-------------------------------------

210160016-GPSSK	AP41 Optical plummet adapter with vial and adjustable height
-----------------	--



## MS27

The MS27 offers unmatched precision and ease of use for viewing and interpreting aerial photographs. The distance between the stereo pairs is 27 cm, and the field of view is a generous 18 x 23 cm. TRA2 tracking device (option) allows for accurate stereoscopic observation over entire overlapped portions of photographs. Illumination unit LA3 is provided as an optional accessory.



2101531A0 with 210150087

### MS27 Specifications

#### Main Unit

Distance of optical path	27 cm
Magnification	Swing-in Magnifier: 1.8x BN3 Binocular: 3x, BN8A Binocular: 8x
Field of view of stereoscope	18 x 23 cm
Field of view of binocular	BN3: 70 mm, BN8A: 27 mm
Range of eye-span	55 to 75 mm
Weight	4.0 kg (8.8 lbs.)

#### PB1 Parallax Measuring Bar

Minimum graduation / estimation	0.05 mm / 0.01 mm
Measurement range	0 to 50mm
Length / weight	39.5 cm / 0.5 kg (1.1 lbs.)

#### TRA2 Tracking Device (optional)\*

Size of photographs	Up to 45 x 45 cm
Range of displacement	Latitudinal: 550 mm / Longitudinal: 450 mm

\*The TRA2 cannot be used with the LA3 Illumination Unit.

2101531A0	MS27 Stereoscope Complete with BN3 & PB1
210153100	MS27W0 Stereoscope Main Unit in Case
210153800	LA3 Illumination Unit
210153700	BN3 3x Binoculars Only
210153600	PB1 Stereometer only (Parallax Bar)
210150087	TRA2 T-27 Track Attachment for MS27
210153300	BN8A 8x Eyepiece Set Converts BN3 to BN8

## MS16

This small mirror stereoscope is compact yet practical with a 16 cm optical path which provides a wide field of view.



### MS16 Specifications

Distance of optical path	16 cm
Magnification	1.5x
Field of view	10 x 10 cm
Weight	0.7 kg (1.5 lbs.)

210153200	MS16 Small Mirror Stereoscope
-----------	-------------------------------

## PS4A & PS2A

Handy lens-type stereoscopes. Distance between lenses is adjustable from 56 mm to 75 mm. Two magnifications available, 4x (PS4A) and 2x (PS2A).

210153400

210153500



210153400	PS2A Pocket Stereoscope (2x with Soft Case)
210153500	PS4A Pocket Stereoscope (4x with Soft Case)

### FIELD BOOKS

Left page with blue horizontal lines and red vertical lines.  
Right page with 4 squares per inch and red vertical line.

- 815260 Field Book (4½ x 7¼ in.)
- Both pages with 10 squares per inch with inch lines slightly heavier
- 815275 Cross-Section Book (6½ x 8½ in.)
- Both pages with blue horizontal lines and red vertical lines. Six vertical columns per page
- 815250 Level Book (4 x 6½ in.)
- Both pages with blue horizontal lines and red vertical lines. Six vertical columns per page
- 815255 Level Book (4½ x 7¼ in.)
- Loose-Leaf Sheets: Single sheets: 50 singles per package, 12 packages per carton, sold by the package
- 815350 Level Book Single Sheets (pkg 50)



### RITE-IN-THE-RAIN® WEATHERPROOF FIELD BOOKS

80 leaves, ruled 8 vertical lines per inch, covered in yellow poly. Size: 4 5/8 x 7 in.

- 815400 Transit Book #300
- 80 leaves, ruled 6 vertical columns per page, covered in yellow poly. Size: 4 5/8 x 7 in.
- 815405 Level Book #310
- Loose-Leaf Sheets - 100 loose-leaf sheets per packs
- 815410 Transit Book Sheets #302 (same layout as 815260)
- 815415 Level Book Sheets #312 (same layout as 815250)

### HIGH-VISIBILITY BUCKRAM BINDERS

Buckram-covered stiff board construction-lined with black paper. Six-ring style.

- 815370 50-page capacity binder with ½ in. rings. Size: 5½ x 7¾ in.
- 815375 100-page capacity binder with ¾ in. rings. Size: 5½ x 7¾ in.



815370





### TRANSIT/ECONOMY FIELD BOOKS

Left page level ruled, right page with 8 vertical and 4 horizontal blue lines and red vertical center line

815200 Transit Field Book (4½ x 7¼ in.)

Loose-Leaf Sheets: Single sheets: 50 singles per package, 12 packages per carton, sold by the package

815300 Transit Book Single Sheets (pkg 50)

Heavy paper cover, spiral bound and 36 pages

815205 Level Book (4 x 6½ in.)

Heavy paper cover, saddle stitched (stapled) and 32 pages

815210 Economy Field Book

815200

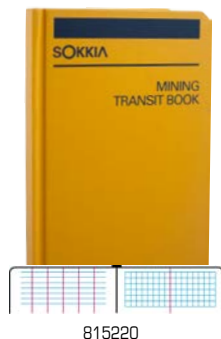

### SPECIALTY FIELD BOOKS

Left page level ruled, right page with 8 squares per inch and red vertical center line

815220 Mining Transit Book (4½ x 7¼ in.)

Left page level ruled, right page with 10 squares per inch, red vertical center line and heavy inch lines

815230 Engineer's Field Book (4½ x 7¼ in.)



815220

815230



### HIGH-VISIBILITY POLYETHYLENE BINDERS

One-piece, 55-gauge single-piece cover resists dirt and withstands tough weather. Six-ring style.

815378 100-page capacity with ¾ in. rings. Size: 5½ x 7¾ in.

815379 50-page capacity with ½ in. rings. Size: 5¾ x 7¾ in.

815378

## LUFKIN TAPE REEL AND FRAME

- For 1/4" or 5/16" x 100' lengths of steel tapes only
- Nickel-plated reel, 2-arm with rollers in each arm for smooth winding
- Oversize drum with long, one-piece winding handle, quick return of line

Item No.	Lufkin No.	Length and Width	Graduations
120150	31100	100/30 m x 1/4 or 5/16 in.	Figure 8, for chain-style tapes
120152-S	31-200	200/50 m x 1/4 or 5/16 in.	D-handle, point, for chain-style tapes
120153 (SO)	31-300	300/100 m x 1/4 or 5/16 in.	D-handle, point, for chain-style tapes



## LUFKIN CHAIN-STYLE TAPES - SUPER HI WAY NUBIAN® 5/16 IN.

- Nominal thickness .017"
- Easy-to-read raised graduations
- Lines have a blank space at each end
- Extra foot before zero graduated right to left to 1/10ths and 1/100ths
- Balance marked every foot except last foot of each 100' length, 100ths
- Reels required: 120150, 120152-S, 120153

Item No.	Lufkin No.	Length and Width	Graduations
122110	09100B	1201-50, 31-100, 100 ft.	Add feet
122120	09200B	1201-52, 31-200, 200 ft.	Add feet
122130 (SO)	09300B	1201-53, 31-300, 300 ft.	Add feet



## CHAINING PINS

Set of 11 chaining pins with alternating red and white colors

724300 14 in. Chaining Pins (Set of 11)

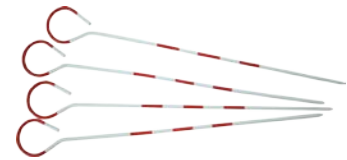

## LUFKIN BANNER TAPES

Item No.	Lufkin No.	Length and Width	Graduations	Color
120315-S (SO)	C216D	100 ft., 3/8 in. wide blade (ring end)	ft./10ths/100ths	Chrome
120325-S	HC256	100 ft.	Inches	Chrome
120335-S (SO)	HW223D	50 ft.	ft./10ths/100ths	n/a
120345-S	HW226D	100 ft.	ft./10ths/100ths	n/a



## LUFKIN ARCHITECT'S POCKET SCALE

Yellow-clad 1/4 in. x 5 ft. blade with black markings and automatic return.  
Scales: 1/4 and 1/8 in. to foot.

120364-S Architect's Pocket Scale Lufkin No.: W393



## NOTE ON GRADUATION STYLES

### Add style feet:

Tapes have a blank space at each end. The extra foot before zero is graduated in 10ths and 100ths from right to left. Balance is marked every foot except the last foot of each 100 ft. length, which is in 100ths of feet.

### Add style metric:

Tapes have a blank space at each end. The decimeter before zero is graduated in millimeters from right to left. Balance is marked every decimeter to meter.



121610

### LUFKIN PEERLESS YELLOW CLAD TAPES

- Designed for engineers and surveyors who prefer a 4-arm reel
- Chrome Clad® and yellow clad blade
- 1/4"/6 mm wide and .016" thick
- Subdivided line removes easily from reel
- Long, easy-action winding handle that locks line in any position
- Nickel plated reel, 4-arm with rollers in each arm for smooth winding
- Open design construction aids in drying line and clearing out dirt
- Pair of 580 finger rings, a 579 engineers conversion rule are furnished
- Reel available separately

Item No.	Lufkin No.	Refill No.	Lufkin Refill	Length/Width	Graduations
121615	Y1276D	121616	RY1276D	100 ft.	ft./10ths/100ths
121620	Y1278	121621	RY1278	200 ft.	ft./in./8ths
121625	Y1278D	121626	RY1278D	200 ft.	ft./10ths/100ths
121630	Y1279	121631	RY1279	300 ft.	ft./in./8ths
121635 (SO)	Y1279D	n/a	RY1279D	300 ft.	ft./10ths/100ths



125253

### LUFKIN NY-CLAD STEEL TAPES

- Durable nylon coating on blade resists wear under extreme conditions
- Super fast 3-to-1 blade retraction saves time in the field
- Steel blade will not stretch under normal use
- Engineers' Scale - 10ths & 100ths of feet

Item No.	Lufkin No.	Refill No.	Lufkin Refill	Length/Width	Graduations
125253	PS1806	n/a	n/a	100 ft.	ft./inches
125254	PS1806D	n/a	n/a	100 ft.	10ths/100ths
125255	PS1808	n/a	n/a	200 ft.	ft./inches
125256	PS1808	n/a	n/a	200 ft.	ft./10ths/100ths

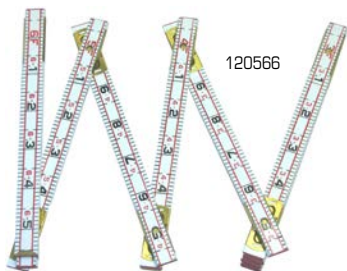

120566

### LUFKIN FOLDING RULES

- For measuring left to right, right to left
- Marked both sides
- Graduated in feet, inches and 1/16ths on both sides and both edges
- Flat inside markings lie close to the work

Item No.	Lufkin No.	Length	Graduations
120247-S	062CME	6 ft./2 m	ft./in./16ths ft. and metric
120566 (SO)	966	6 ft.	ft./in. and metric
120575	1066D	6 ft.	ft./10ths/100ths and ft./in./16ths ft., Heavy Duty
120576	1066DM	6 ft./2 m	ft./10ths/100ths/metric, Heavy Duty



125248

### LUFKIN FIBERGLASS OPEN-REEL TAPES

- Lightweight open reel is easy to handle and rewind
- Hi-Viz® orange case
- Blade style: C1

Item No.	Lufkin No.	Length	Graduations
125244	1706D	100 ft.	10ths
125248	1706	100 ft.	inches
125251	HY1730CME	100 ft./30 m	ft./meters

### LUFKIN SERIES 2000 IN CHROME-PLATED CASES

- Case designed to fit perfectly in the hand
- Lightweight, high strength chrome finished case
- Fits easily into most tape holsters
- Bright yellow blade has clear easy-to-read numerals
- Toggle lock positioned for convenient operation, holds blade securely
- Cushioned blade return
- Removable belt clip
- All shelf pack power tapes are carded



120112-S

Item No.	Lufkin No.	Blade Length and Width	Graduations
120112-S	2312D	¾ in. x 12 ft.	ft./in./16ths & ft./10ths/100ths
120122-S	2325D	¾ in. x 25 ft.	ft./in./16ths & ft./10ths/100ths
120133	2133D	1 in. x 33 ft.	ft./in./16ths & ft./10ths/100ths

### LUFKIN SERIES HV1000 IN BLAZE ORANGE CASE

- Hi-Viz® case - easy to find on the job
- Lightweight, high strength case designed to fit perfectly in the hand
- Fits easily into most tape holsters
- Bright yellow blade has clear easy-to-read numerals
- Toggle lock positioned for convenient operation, holds blade securely in any position
- Virtually unbreakable Quad Hook; four rivets for extra strength
- Cushioned blade return
- Removable belt clip



120128



120134

Item No.	Lufkin No.	Blade Length and Width	Graduations
120113-S	HV1048DM	1 in. x 25 ft./7.5 m	ft./10ths/100ths/metric
120115-S	HV1048CM	25 mm x 8 m	metric
120121	HV1425ED	1 in. x 25 ft.	ft./10ths/100ths
120124-S	HY1034DM	¾ in. x 12 ft.	10ths/metric
120128	HV1425D	1 in. x 25 ft.	ft./in./16ths & ft./10ths/100ths
120134	HV1312D	¾ in. x 12 ft.	10ths
121915 (SO)	HV1048CME	1 in. x 26 ft./8 m	ft./in./8ths/metric
121916	HV1433DM	1 in. x 33 ft./10 m	ft./10ths/100ths/metric

### KOMELON MEASURING TAPES WITH BELT CLIPS

Available in power tapes, fiberglass tapes or nylon coated steel tapes in many lengths and graduation styles. All cases and reels are sturdy Hi-Visibility green ABS plastic.

870625	1" x 25' Power Tape	Graduations: in/10ths
1001599-01	1" x 33' with nylon coated blade	Graduations: in/10ths



870625



1001599-01

### SOKKIA/ESLON FIBERGLASS UTILITY TAPES (¼ IN. WIDE)

Especially good for topographic surveys. Extremely light and slip- and tear-proof. (Not supplied with reel)

845022	Length: 50 m	Graduations: 5 cm
--------	--------------	-------------------



### SOKKIA/ESLON™ FIBERGLASS OPEN-REEL TAPES (½ IN. WIDE)

Lightweight case is virtually shatterproof. The special handle design makes reeling quick. Width ½ in., with folding metal end hook.

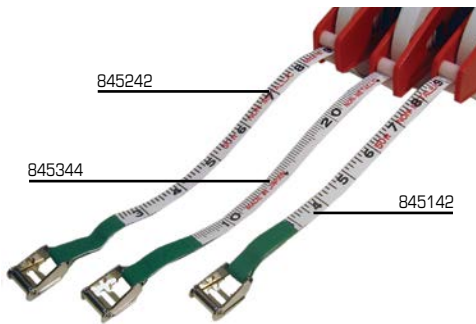

Item No.	Refill No.	Length
Printed on one side. Graduated in ft./in./8ths.		
845144	845164	100 ft.
845146	n/a	200 ft.
845148	n/a	300 ft.

Printed on both sides. One side graduated in ft./in./8ths, other side m/cm/2 mm.		
845444	845464	100 ft./30 m
845445	n/a	165 ft./50 m

Printed on one side. Graduated in ft./10ths/100ths.		
845244	845264	100 ft.
845245	845265	165 ft.
845246	845266	200 ft.

Printed on both sides. One side graduated in ft./10ths/100ths, other side m/cm/2 mm.		
845542	n/a	50 ft./15 m
845544	845564	100 ft./30 m
845545	845565	165 ft./50 m

Printed on one side. Graduated in m/cm/2 mm.		
845344	845364	30 m
845346	n/a	60 m
845348	845368	100 m

Printed on one side. Graduated in ft./10ths/100ths.		
845244	845264	100 ft.
845245	845265	165 ft.
845246	845266	200 ft.

Printed on both sides. One side graduated in ft./10ths/100ths, other side m/cm/2 mm.		
845542	n/a	50 ft./15 m
845544	845564	100 ft./30 m
845545	845565	165 ft./50 m

Printed on one side. Graduated in m/cm/2 mm.		
845344	845364	30 m
845346	n/a	60 m
845348	845368	100 m

Printed on one side. Graduated in m/cm/2 mm.		
845344	845364	30 m
845346	n/a	60 m
845348	845368	100 m

Printed on one side. Graduated in m/cm/2 mm.		
845344	845364	30 m
845346	n/a	60 m
845348	845368	100 m

### SOKKIA/ESLON FIBERGLASS APPRAISER'S TAPES

These long-lasting tapes have special hook ends to assure accuracy.



Item No.	Refill No.	Length
Printed on one side. Graduated in ft./in./8ths.		
845174	845174	100 ft.

Printed on one side. Graduated in ft./10ths/100ths.		
845274	845284	100 ft.

Printed on one side. Graduated in ft./10ths/100ths.		
845274	845284	100 ft.

Printed on one side. Graduated in ft./10ths/100ths.		
845274	845284	100 ft.



### SOKKIA/ESLON WARRANTY

Sokkia/Esilon tapes are covered by a 90 day warranty. If your Sokkia/Esilon tape breaks or if it is defective, Sokkia Corporation will replace it at no charge for up to 90 days from the original date of purchase. This warranty also covers defective or broken tape reels and cases. Details are supplied with tapes.

## SUUNTO COMPASS/CLINOMETERS

### Compasses

802442	51-MC-2D Mirror Compass 0-360°
--------	--------------------------------

### Sighting

802510	51-KB20/360R Compass 0-360°
--------	-----------------------------

### Accessories

802503	51-K1335 Rubber Cover, Fits: 802530/802540/802575/802590 (SO)
--------	---

### Twin Precision Compasses/Clinometers

Two instruments in one. Built-in prismatic sighting for fast field use. Resists corrosion, water and impact. Use for directional indications and slope/height measurements with an accuracy of  $\pm 0.25^\circ$ .

802506	1380 Tandem Compass/Clinometer
--------	--------------------------------

### Clinometers

Use as a hand level, builder's level, optical plummet and slope indicator. Measures vertical angles, computes height, determines slope angles and levels for rough surveying. Liquid will not freeze or evaporate.

802575	51-PM5/360PC Clinometer
802590	51-PM5/66PC Height Meter with Slope Scale

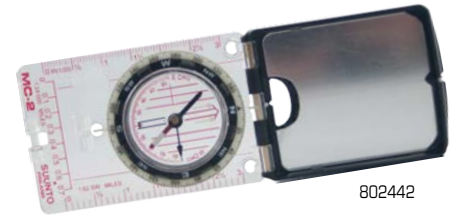

802442



802506



802510



802575

## USHIKATA SURVEYING COMPASS

Handy and compact. A unique "O-BAC" device for one-touch zero setting provides a horizontal reading. Quick magnetic readings with a magnetic induction damper and stadia survey is available with the telescope reticle. Perfect for mountain, forest and range surveying.

### S-25 Specifications

Telescope	Reversible, erect, 12x, 120 mm long
Horizontal Circle	5', "O-BAC" zero setting
Compass Circle	Diameter 70 mm, 1°
Verticle Circle	Full circle, 1°
Weight	1.0 kg

802635	Surveying Compass with Telescope and Case, 0-360° Ushikata Tracon S-25
--------	--

802633	Aluminum Extension Tripod with Case (Ushikata Model No. 33)
--------	---



802635



802633



800610

### THERMOMETERS

This magnet reset, mercury filled thermometer includes a tenite case. Range -40° to 120°F in 2° increments. Non-refillable.

800600 Max.-Min. Thermometer

This 5½ in. long thermometer is mercury filled and has a range of -40° to 120°F in 2° increments. Non-refillable.

800610 Pocket Thermometer

The same features as 800610 except with range: 0° to 220°F. Non-refillable.

800620 Pocket Thermometer (SO)

Pocket Thermometer with plastic case that's 5½ in. long. Mercury filled; range: -40° to 120°C in 1° increments. Non-refillable.

800611 Pocket Thermometer-Celsius (SO)

The same features as 800611 but with a refillable metal case.

800614 Refillable Pocket Thermometer (SO)

Read indoor and outdoor temperatures from inside with bold red and blue numerals. Extend tubing out window to read outdoor temperatures. Range: -45° to 115°F / -40° to 55°C.

800692 Indoor/Outdoor Thermometer (SO)

800600



800672

800650

### BI-THERM THERMOMETERS

As accurate as mercury thermometers, but without the need for safety precautions to avoid potential toxicity. Measures temperature with a bi-metallic coil attached to an indicator needle.

800650 1 in. dial; -40° to 160°F

800651 1 in. dial; -40° to 50°C (SO)

800660 1 in. dial; 0° to 220°F

800672 2 in. dial; 0° to 550°F

800601 1¾ in. dial; 50° to 550°F

### POCKET DIGITAL THERMOMETER

High precision pocket digital thermometer. Able to be recalibrated. Maximum/minimum temperature feature retains memory even when turned off. Two-stage off button with timer, auto-off feature to conserve battery, replaceable watch battery installed. 4½ in. stainless steel stem.

800690 Pocket Digital Thermometer



## STAKE BAGS

Sokkia Heavy-Duty Stake Bag made from durable orange material and made to carry 18 in. or 24 in. stakes. These bags are made with a drain hole and an adjustable carrying strap.

801055	Heavy-Duty Stake Bag 18 in.
801056	Heavy-Duty Stake Bag 24 in.
801057	Rhinotek Stake Bag 18 in.



## LATH BAGS

Sokkia Heavy-Duty Lath Bag made from durable orange material and made to carry 36 in. or 48 in. lath. These bags have an adjustable carrying strap.

801065	Heavy-Duty Lath Bag 36 in.
801066	Heavy-Duty Lath Bag 48 in.



## CARRY-ALL CASE

Sokkia Heavy-Duty Carry all bag will allow you to carry a full size wood tripod and also include an 8 ft. prism pole.

801080	Heavy-Duty Accessory Carry-All Case - 58 L x 9¼ D in.
--------	---



## PRISM BAGS

Sokkia Heavy-Duty Prism bags that are padded with thick dense foam and the exterior is made from durable orange material.

801070	Heavy-Duty Single Prism Bag, Interior Dimensions - 12 x 10 x 4 in. (w x l x d)
801071	Heavy-Duty Prism System Bag, Interior Dimensions - 12 x 18 x 5 in. (w x l x d)

## DATA COLLECTOR CASES

Sokkia Data Collector Carrying Cases

559314	S10 / SHC25 Carrying Case
559316	Mesa Carrying Case
60958-SURSK	Archer2 / SHC250 Carrying case
804903	Universal Data Collector Case



\*All Bags are Made in USA.





8110\_ / 8112\_

### PRESCO "TEXAS" FLAGGING

Colorfast and rainproof. Contains no toxic lead. Packed one dozen to a box; sold by the box. Size: 1 in. wide. Note: Colors cannot be assorted within the box.

- 8110\_ \_ Solid 300 ft. roll. Specify color with last two digits:  
-00 Red, -01 Orange, -02 Blue, -03 Yellow, -04 White, -06 Black, -11 Green.
- 8112\_ \_ Florescent 150 ft. roll. Specify color with last two digits:  
-00 Red Glo, -01 Orange Glo, -03 Yellow Glo, -04 Pink Glo, -06 Lime Glo

### PRESCO "ARCTIC" FLAGGING

Excellent durability, performance, and temperature resistance down to -40°F. Packed one dozen to a box; sold by the box. 3 mm for standard colors, 5 mm for florescent colors.

Note: Colors cannot be assorted within the box.

- 8110\_ \_ Florescent 150 ft. roll. Specify color with last two digits:  
-69 Yellow Glo, -70 Orange Glo, -71 Pink Glo, -72 Blue Glo, -73 Lime Glo.
- 8110\_ \_ Solid 300 ft. roll. Specify color with last two digits:  
-77 White, -78 Blue.

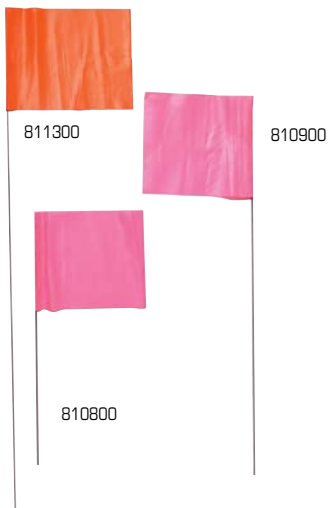

811300

810900

810800

### STAKE FLAGS

Vinyl flags securely attached to stiff steel wire stakes. Packed 100 to a bundle with 10 bundles per box. Sold by the box. Order in increments of 10.

- 8108\_ \_ Small Flags (2½ x 3½ in.) – 21 in. stakes. Specify color with last two digits:  
-00 Pink Glo, -01 Orange Glo, -03 Yellow, -06 White
- 8109\_ \_ Small Flags (2½ x 3½ in.) – 30 in. stakes. Specify color with last two digits:  
-00 Pink Glo, -01 Orange Glo, -03 Yellow, -04 Red, -06 White
- 0802\_ \_ Large Flags (4 x 5 in.) – 21 in. stakes. Specify color with last two digits:  
-11 Blue, -12 White, -13 Red, -14 Blue Glo, -15 Yellow, -16 Orange Glo, -17 Pink Glo, -18 Yellow Glo, -19 Red Glo, 099992 Orange
- 0803\_ \_ Large Flags (4 x 5 in.) – 30 in. stakes. Specify colors with last two digits:  
-01 Blue, -02 Orange Glo, -03 Red, -04 White, -05 Yellow, -06 Blue Glo, -07 Pink Glo, -08 Lime Glo, -09 Red Glo, -16 Yellow Glo, -24 Orange, 080298 Green, 099071 Green Glo.
- 8113\_ \_ Large Flags (4 x 5 in.) – 36 in. stakes. Specify colors with last two digit:  
-00 Pink Glo, -01 Orange Glo, -02 Blue, -03 Yellow



### FLAGGING TAPE DISPENSER

Lightweight, rustproof and fits on a belt or waistband. Holds one roll.

- 811010 Flagging Dispenser



11753

### STAKE WHISKERS

Packed 25 per bundle. 40 bundles per box.

- 117\_ \_ -41 Orange, -50 Red, -51 Blue, -53 Pink Glo, -54 White, -55 Orange Glo.

### AERIAL FLAGGING

Perfect for aerial mapping jobs where high visibility marking is needed for photography. Sold by the roll.

- 10164 White Roll, 300 ft. x 12 in.

### MAG NAILS

Revolutionary new metal formula doubles or quadruples detection by metal detectors by retaining magnetism. Larger center point for easier driving. Packaged in boxes of 100.

813345	3/4 x 1/8 in.
813346	1 x 5/32 in.
813347	1 1/4 x 3/16 in.
813348	1 1/2 x 1/4 in.
813349	2 x 1/4 in.
813350	2 1/2 x 1/4 in.



813345

### FLAT SURVEY MARKERS (MADE IN USA)

Cast from solid brass. Ribbed shank prevents turning or loosening. Non-glare finish, 1/8 in. thick top. Shank area 0.4 sq. in., length: 2 in.

813400	1 3/8 in. Top Diameter
813403	2 in. Top Diameter
813406	2 1/2 in. Top Diameter
813408	3 in. Top Diameter
813408-SF	3 in. Top Diameter Satin Finish



813406

### STAKE TACKS

Steel, 7/8 in. long tacks with indented head to guide plumb bob point. Approximately 725 per 1 lb. box.

813270	Stake Tacks
096000	Tack Ball



813270

### DOMED SURVEY MARKERS (MADE IN USA)

Solid brass with curved heads. Ribbed shank prevents turning or loosening. Shank area: 0.4 sq. in.; shank length: 2 in.

813410	1 3/8 in. Top Diameter
813413	2 in. Top Diameter
813416	2 1/2 in. Top Diameter
813418	3 in. Top Diameter



813416

### NAIL MARKERS

One-inch squares made of plastic impregnated nylon in florescent orange. Approximately 70 per package.

811501	Nail Markers with 1/4 in. hole
811502	Nail Markers with 1/8 in. hole



811501

### SURVEYOR'S RAISED SHINERS

Tin, 1 1/4 in. diameter with center punch and crimped edges. Especially valuable for indicating semi-permanent points with spikes or nails. 1 lb. carton. Approximately 250 per box.

813431	Raised Shiners
--------	----------------



### MONUMENT SPIKES

Large monument spike 3/8 in. square shank. Galvanized with chisel point and button head. Makes ideal bench mark or turning point.

813262	6 in. Monument Spike
813264	8 in. Monument Spike



813262

### MAG HUBS

The Mag Hub is magnetized for easy detection and zinc plated to resist corrosion. It has a large center point and is easy to carry. Not for use in concrete or asphalt. 30 lb. box. 1/4 in. diameter.

813351	4 in. Mag Hub Nail
813352	6 in. Mag Hub Nail
813353	8 in. Mag Hub Nail



813351

### LEAD WIRE

For lead and tack reference points. Fits hole cut by No. 813089 concrete drill. Diameter: 3/8 in., Length: 15 in.

813220	Lead Wire
--------	-----------



### SURVEYOR'S FLAT SHINERS

Tin, 2 1/4 in. diameter with center punch and crimped edges. Especially valuable for indicating semi-permanent points with spikes or nails. 3 lb. carton.

813430	Flat Shiners
--------	--------------





812214

### PLUMB BOBS

Screw caps and hardened steel points with standard threads. Storage space for an extra point inside the cap.

812212	12 oz. Plumb Bob
812214	14 oz. Plumb Bob
812216	16 oz. Plumb Bob
812218	18 oz. Plumb Bob
812224	24 oz. Plumb Bob
812290	Extra Point (fits all listed plumb bobs)
812293	Extra Cap (fits all listed plumb bobs)



812440

### PLUMB BOB CORDS

Made with the finest quality braided cord.

812413	White Poly; 50 yd. Spool
812423	Orange Poly, 50 yd. Spool
812439	Fluorescent Yellow Poly, 50 yd. Spool
812440	Flourescent Red Poly, 50 yd. Spool



812365



812325

### LEATHER SCABBARDS

Rugged leather with stitched and riveted pockets that hold tape or Gammon Reel and a 16 or 18 oz. plumb bob.

812365	Leather Scabbard for Gammon Reel and Plumb Bob
--------	--

Extra-heavy stitched and riveted pocket.

812350	Belt for Plumb Bob Scabbard
812315	Scabbard for 10–14 oz. Plumb Bobs
812325	Scabbard for 16–18 oz. Plumb Bobs
812335	Scabbard for 24–32 oz. Plumb Bobs



### TALLY REGISTER

Four-digit capacity with quick return to zero.

879200	Tally Register
--------	----------------



812450



812448

### GAMMON REELS

Handy, retracting plumb bob cord reel means no more winding and no more broken or muddy string. Includes 72 lb. test nylon string that weighs 1½ oz.

812448	12 ft. Gammon Reel, Black/Orange
812449	12 ft. Gammon Reel, White/Orange
812450	6½ ft. Gammon Reel, White/Orange
812451	24 yd. Nylon Refill, Red/Orange
812452	24 yd. Nylon Refill, Fluorescent Yellow
812454	24 yd. Nylon Refill, Fluorescent Red



812620

### TARGETS

Available in "Quik-Stik," plastic and translucent plastic variations.

812620	Plastic target notched for attaching to line 2½ x 4 in., red/white
812625	Translucent Plastic target laminated for brilliant illumination and notched for attaching to line 2¼ x 4 in., black/orange
812640	Quik-Stik target with paper back that peels off instantly and sticks to any surface 2 x 3½ in. (package of 25)

**AXES**

813035	Estwing® Hand Axe with Leather Sheath, 1.7 lbs.
813015	Bahco Bush Axe 7¼ in. Swedish Steel Blade, 20 in. Hickory Handle
813016	Bahco Replacement Handle: 20 in.
813017	Bahco Replacement Blade
813019	Hatchet Axe with Leather Sheath (SO)
813005	Hatchet Broad 36 oz. Plumb Axe
813045	Estwing Broad Hatchet, 17 in., 28 oz. (SO)



**HAMMERS**

813030	Estwing Hammer: 30 oz.
813065	Estwing Straight Claw Hammer: 16 oz.
813022	Estwing Rock Pick Hammer: 11½ in. Handle, 22 oz.
813023	Sheath for Estwing Rock Pick Hammer
813007	Estwing Long Handle Rock Pick Hammer: 16¼ in. Long Handle
813039	Estwing Rock Pick with Leather Wrapped Grip: 13 in. (SO)
813012	Engineering Sledge: 15 in. Handle, 4 lbs.
813013	Engineering Sledge Replacement Handle
813037	Estwing Sledge/Drilling Hammer: 4 lbs.
813038	Estwing Sledge/Drilling Hammer: 3 lbs.
813060	Sledge/Drilling Hammer: 4 lbs., 16 in. Long Handle
813146	Engineer's Hammer: 48 oz.
813018	Sledge Drill Hammer: 10 in. Handle, 4 lbs.



**CHISEL**

813085	Estwing Concrete Chisel: ½ x 12 in.
--------	-------------------------------------

**CONCRETE DRILL**

813089	Concrete Drill: 10 x 5/8 in., "V" Edge
--------	--

**GAD**

813080	Gad: ¾ x 1¾ x 18 in.
--------	----------------------

**FROST PIN**

813079	REDTOP Frost Pin: 1 in. Diameter, 1¾ in. Button Top, 18 in. Long, 4 lbs.
--------	--





**MACHETES**

813000	Seymour® 22 in. Machete
813001	Leather Sheath for 22 in. Machete
813002	Canvas Sheath for 22 in. Machete



**DITCH BANK BLADE**

813008	Ditch Bank Blade: 16 in. Blade, 10 in. Handle
813009	Replacement Handle

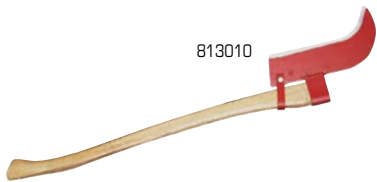

**BUSH HOOK**

813010	Bush Hook: 12 in. Single Edge, 36 in. Handle
813011	Replacement Handle



**MANHOLE COVER PICK**

813081	REDTOP Heavy Duty Manhole Cover Pick Diamond Point: 31 in. Long
--------	---



**PROTRACTOR**

812911	Small Angle Magnetic Protractor Full-view MONO-VIAL®; dial graduated to 5°; magnetic base and durable Polycast® construction
--------	--

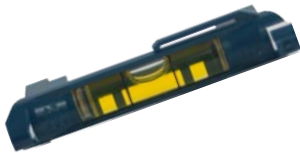

**LEVELS**

812910	Line Level: 3 in. Long
--------	------------------------



**TOOL POUCHES**

818116	7-Pocket Tool Pouch
818115	Leather Tool Pouch

818116

818115

**DIXON REDIMARK® MARKER**

Tight-seal, no-roll cap makes marker last longer; stores on base when not in use. Chisel point is ideal for marking on wood, metal, glass, plastic or paper. Aluminum body gives 30% more volume. Sold by the dozen.

813471	Black Dixon Felt Tip Marker
813472	Red Dixon Felt Tip Marker



813471

**IDEAL MARK® MARKING PEN**

Industrial-grade marker for surveying and construction layout. Valve action with indelible black ink. Replaceable tip and metal cap with pocket clip. Sold by the dozen.

813501	Black Ideal Mark with Replaceable Bullet Tip, Box of 12
813502	Red Ideal Mark with Replaceable Bullet Tip, Box of 12
813503	Replacement Tip, Bullet Style (12 tips per package)
813504	Replacement Tip, Chisel Style (12 tips per package)



813501

**CARBIDE POINT SCRIBES AND HEAVY DUTY SCRIBERS**

For marking steel, concrete, stone, lumber and almost any other surface.

813050	Carbide Point Scriber; 5¼ in.
813051	Replacement Scriber Point (6 per package)
813053	Premium Scribe; 5 in.
813054	Giant Scribe
813055	Replacement Tip for 813053/813054 (6 per package)



813050

813053

**DIXON® LUMBER CRAYONS**

For marking steel, concrete, stone, lumber and almost any other surface. Length: 4½ in.; diameter: ½ in. Packed 12 per box; sold by the box.

813461	Carbon Black Crayon
813462	Yellow Crayon
813463	Red Crayon
813464	Fluorescent Pink
813465	Blue Crayon
813467	White Crayon



813462

**DIXON® WOOD CRAYON HOLDER**

813468	Wood Crayon Holder
--------	--------------------





### AERVOE MARKING PAINT (17 OZ.)

- Aervoe's Survey Marking Paint offers the best in color visibility and retention, durability, and a lasting mark of up to six months
- Non-freezing and operational to 14°F
- Colors are formulated to meet standards set by OSHA and APWA/One Call Systems
- Mark is visible for up to six months depending on traffic and exposure
- Adheres to many surfaces including wood, concrete, asphalt, brick and gravel
- Not recommended for use on turf surfaces

813454	Flo Orange #222
813460	Flo Pink #229

### SPRAY PAINT MARKING WAND

Lightweight durable steel and plastic construction with a comfortable grip for easy marking.



813958	Marking Wand, 24 in. Handle
--------	-----------------------------

### SPRAY PAINT MARKING PISTOL

Use with marking paints for increased accuracy and no mess. Light touch spray control. Easy loading.



813959	Marking Pistol
--------	----------------

## HARD HATS

High-density polymer for excellent protection against severe impact. Molded in one piece with no metal; protects against corrosive materials. Meets ANSI Z89. 1-196 (Class A) — Federal Spec GGG-H-142g. Fits sizes 6 3/8 through 8. Weight: 11 oz.

813630	Yellow
813631	White



813630

## SURVEYOR'S UMBRELLA

63 in. spread and 8 ft., 3-section pole with baked aluminum enamel finish

813640	Heavy-drill fabric umbrella; blue and yellow
813641	Water resistant vinyl umbrella; yellow with blue logo
813642	Replacement Pole for 813640/813641, diameter 1 1/4 in. (ISO)



813640

## FIRST AID KITS

The jobsite kit is designed to serve most minor first aid issues for up to 25 people. The truck kit is designed for up to 10 people.

813094	First Aid Kit (Truck)
813095	First Aid Kit (Jobsite)



813094

## COMMON SOKKIA CABLES – BATTERIES – CHARGERS

210160056	BDC35A (SET x100 Series, PowerSET)
60901-SURSK	BDC46A (RCPR3/4/5, SDL30/50, SET 30R series)
221007000-SURSK	BDC70 (SX, SRX, NET, CX, FX)
210160091-SURSK	CDC68 Charger (for BDC70 and BDC46)
402-0-0084	GSR2700IS/ISX Internal Battery
51288-SURSK	Hirose to 9pin cable (older SET's, Gowin, Cygnus, SET60)
635039	DOC27 USB to Hirose (USB adaptor for Hirose connector to go to USB port)
1001550-01-SURSK	DOC210E (SX, CX, FX to 9 pin)

402-0-0084



210160056



60901-SURSK



221007000-SURSK



635039



1001550-01-SURSK



51288-SURSK



210160091







813612

### TRAFFIC CONES

High-intensity fluorescent red-orange PVC cone with weighted base for stability.

813612	12 in. Traffic Cone
813618	18 in. Traffic Cone
813619	28 in. Traffic Cone



813652

### NON-REFLECTIVE "SURVEY CREW" SIGN

Non-reflective, high-visibility orange sign with rib support. Roll-up design for daytime use. Stand sold separately.

813652	36 in. SURVEY CREW non-reflective sign
813653	48 in. SURVEY CREW non-reflective sign
813656	Replacement Rib Set 36 in.
813657	Replacement Rib Set 48 in.

### REFLEXITE "SURVEY CREW" SIGN

Reflexite Super Bright™ orange sign with rib supports. Roll-up design for day and night visibility. Stand sold separately.

813654	36 in. SURVEY CREW Reflexite sign (SO)
813655	48 in. SURVEY CREW Reflexite sign (SO)
813656	Replacement Rib Set 36 in.
813657	Replacement Rib Set 48 in.



813651

813650

### UNIFLEX SCREWLOCK SIGN STAND

NCHRP-350 approved design. Single heavy-duty coil spring to hold 36 in. and 48 in. signs. Kick-release adjustable legs for easy setup. Stand only. Sign sold separately.

813651	Uniflex Screwlock Sign Stand
--------	------------------------------

### T-50 ECONOMY TRIPOD SIGN STAND

NCHRP-350 approved design with roll-up signs on low speed roadways. Holds 36 in. or 48 in. signs. For day and night visibility. Stand only. Sign sold separately.

813650	T-50 Economy Tripod Sign Stand
--------	--------------------------------



### CAUTION TAPE

Caution tape; yellow; 3 mil, 1,000 ft.

811050	Caution Tape (1 roll)
--------	-----------------------





# **SOKKIA**

16900 W. 118th Terrace • Olathe, KS 66061

800.4.SOKKIA • [www.sokkia.com](http://www.sokkia.com)

SOK-1017 Rev C 1/16

Due to the printing process, the colors of the products printed in this catalog may vary slightly from those of actual products.

Products displayed within are not to scale. Designs and specifications are subject to change without notice. All weights are approximate.

Certain products in this catalog may not be available in specific market areas. Please consult with your nearest Sokkia representative for details.

© 2016 Topcon Corporation. All rights reserved. Sokkia is a trademark of Sokkia Topcon Co. Ltd. Other trademarks and trade names are those of their respective owners.