

SOKKIA

# SHC6000

Field Computer

Operator's Manual

Copyright © 2022 Sokkia, Inc. All rights reserved. Information is subject to change without notice.

Sokkia® is a registered trademark of Sokkia, Inc. SHC6000 field computer is a recognized trademark of Sokkia, Inc.

Windows®, Windows 10, and the Windows logo are trademarks or registered trademarks of Microsoft Corporation in the United States and/or other countries.

The *Bluetooth*® word mark is owned by the Bluetooth SIG, Inc. Any use of such marks by Sokkia, Inc. is under license.

The names of other companies and products mentioned herein may be the trademarks of their respective owners.



**WARNING!** This symbol indicates that failure to follow directions could result in serious injury.



**CAUTION:** This symbol indicates that failure to follow directions could result in damage to equipment or loss of information.

Part Number 28662-02 JS, 1034928-01 Sokkia

# SOKKIA

tel: 1-800-4-Sokkia | web: <http://us.sokkia.com/>  
16900 W. 118th Terrace, Olathe, KS 66061

# Contents

<b>1</b>	<b>Getting Started</b>	<b>1</b>
	Overview	2
	The Anatomy of the SHC6000	2
	Perform Initial Tasks	4
<b>2</b>	<b>Standard Features</b>	<b>7</b>
	Keypad Features	9
	LED Activity Indicators	10
	Light Sensor	11
	Connector Ports	11
	Audio Features	12
	Sensors	13
	<b>Bluetooth</b> ® Wireless Communication	13
	Wi-Fi Wireless Networking	14
	GPS/GNSS	14
	Camera	15
	Power Management	15
<b>3</b>	<b>Optional Features and Accessories</b>	<b>19</b>
	4G LTE Data Modem	20
	Office Docking Station	21
	Battery Charger	24
<b>A</b>	<b>Storage, Maintenance, and Recycling</b>	<b>25</b>
	Storing the SHC6000 and Battery Pack	26
	Protecting the Touchscreen	26
	Recycling the SHC6000 and Batteries	27
<b>B</b>	<b>Warranty and Repair Information</b>	<b>29</b>
	Limited Product Warranty	30
	Complete Care Service Plans	33

<b>C</b>	<b>Warnings, Regulatory Information, Licensing</b>	<b>35</b>
	Product Warnings.....	36
	Certifications and Standards.....	38
	Licensing Information.....	40
<b>D</b>	<b>Specifications</b>	<b>43</b>
	<b>Index</b>	<b>51</b>

# 1

## Getting Started



# Getting Started

## Overview

The SHC6000 field computer from Sokkia uses the Windows 10 Pro or Windows 10 IoT Enterprise operating system. Standard features include a 7" display, capacitive touchscreen, keypad, *Bluetooth*, Wi-Fi, GPS/GNSS, and front and rear cameras. Standard accessories include a removable battery pack, an AC wall charger, a hand strap, a connector port cover, a fine tip capacitive stylus and tether, and a foam tip stylus for use in wet conditions. Optional features include a 4G LTE data modem.

## The Anatomy of the SHC6000 Front and Back Features



- 1 Ambient Light Sensor
- 2 Front Facing Camera Lens, 2 MP
- 3 Keypad
- 4 Power Key
- 5 Notification LEDs
- 6 Touchscreen and Display
- 7 Protective Over-molded Bumper (all four edges)
- 8 Microphone (one on each side)

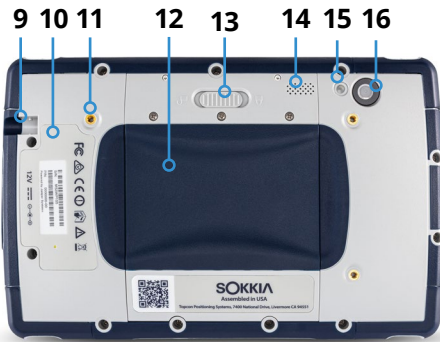

- 9 Storage Slot for Fine Tip Stylus
- 10 Location of Internal Battery (not user accessible)
- 11 External Device Attachment Point (1 of 3 on the back)
- 12 Door to Removable Battery Compartment and Card Slots
- 13 Battery Door Lock
- 14 Speaker
- 15 Camera Flash
- 16 Rear Facing Camera Lens, 8 MP

## Battery Compartment and Card Slots



- 1 Battery Pack, Removable
- 2 Battery Door
- 3 Micro SIM Card Slot and Micro SD/SDHC Card Slot (underneath card retainer)

- 4 Flexible Card Retainer
- 5 Battery Compartment
- 6 Docking Connection
- 7 Hand Strap Attachment Point (2 on each side)

## Connector Ports



- 8 Connector Port Protector
- 9 12 VDC Power Input Jack
- 10 USB 3.0 Host, Full Size
- 11 Audio Jack
- 12 Storage Slot for Fine Tip Stylus

## Perform Initial Tasks

When you receive your SHC6000, perform the tasks outlined in this section before first use.

### Review Documentation

This owner's manual and other documents like release notes are available on our website at: <https://us.sokkia.com/sokkia-care>. View, download, and print documents as desired, either on the SHC6000 or another computer with an internet connection. A PDF viewer is included with your SHC6000 apps.

### Install and Charge the Battery Pack

The SHC6000 comes with a rechargeable and removable Li-Ion battery pack. Install and charge the battery pack as follows:

1. The battery compartment is accessed from the back of the SHC6000. Push the battery lock switch in, slide it to the unlocked position, and remove the door.



**CAUTION:** The SHC6000 is not sealed against water and dust when the battery door is not installed.

2. If you are using a micro SD card for additional memory or a micro SIM card with the Cellular Data Modem (optional), you can install them now before you install the battery pack or at another time. If you do this, make sure you replace the flexible card retainer before installation of the battery. See *Chapter 2, SD Cards* or *Chapter 3, Install the SIM Card* for details.
3. Follow the graphic on the battery label to insert the battery pack properly.

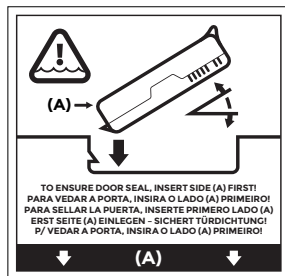

Hold the battery so that the black tab on the front edge of the battery is up and facing the door latch (this tab



helps you pull the battery out). Place the back edge in first, gently pushing it underneath the two battery catches. Rotate the front edge down until it is in position.



**CAUTION:** Do not insert the battery pack straight down. Damage to the unit could occur.



4. Replace the door and press down on it until the latch pops into the locked position.
5. Attach the appropriate plug for your country into the AC wall charger and plug it into a wall socket. Plug the other end into the DC power jack on the SHC6000.

*Note: Use the AC wall charger that came with the SHC6000 or another approved charger from Sokkia.*

6. Charge the battery pack at room temperature (68°F or 20°C) for 6 hours (for the first charge). While the battery pack is charging, the red LED blinks. When it is fully charged and external power is applied, the red LED is solid.

*Note: The SHC6000 will not recognize an internal battery until the SHC6000 is being charged for the first time.*

## **Perform Set Up**

The first time the SHC6000 is powered on, Windows setup options are shown. Follow the prompts to set up your unit as desired.

## Attach the Hand Strap and Stylus Tether

A hand strap, fine tip capacitive stylus, and tether are included with the SHC6000.

### ***Hand Strap***

To attach the hand strap to the SHC6000, follow the images below. You can attach it to the right or left side of the SHC6000:



1



2



3

### ***Stylus Tether***

1. Attach one end of the stylus tether to the stylus.
2. Push the free tether loop through one of the tether attachment points located on the side of any of the four corners of the SHC6000.



3. Insert the stylus with the attached tether through this loop and tighten the loop.
4. Place the stylus into the stylus storage slot located on the bottom of the SHC6000.

# 2

## Standard Features



# Standard Features

This chapter discusses the standard features included with every model of the SHC6000 field computer with Windows 10 Pro or Windows 10 IoT Enterprise.

## Display and Touchscreen

The SHC6000 has a bright color display and capacitive touchscreen with a diagonal viewing area of 7 inches (178 mm).

### Display and Touchscreen Profile Settings

#### ***Display Settings***

To adjust the display settings including the text size, brightness, and orientation, go to the Action Center and select *All settings > System > Display*.

#### *Backlight Brightness*

There are a few shortcuts to adjust the display backlight brightness.

Open the Action Center. Tap the percent tile (sun icon) to toggle the display backlight brightness up or down in 25% increments from 0% to 100%. This same tile can be accessed by tapping the battery icon on the desktop. To simply dim the backlight, tap the *Battery saver* tile. Tap it again to return it to the previous brightness.

#### ***Touchscreen Profile Settings***

To adjust the touchscreen profile, go to the Start menu and select *Touchscreen Profiles*. Select the touch profile you want the screen optimized for: Finger and Stylus (default), Finger, Stylus, Wet, or Glove. As the new profile loads, a progress bar is shown. You can try different profiles to see which one works best.

#### *Using the SHC6000 in Wet Conditions*

When using the SHC6000 in wet conditions, you must use your finger or the soft-tipped stylus that is included on the capacitive touchscreen and hold your SHC6000 at a minimum 30-degree angle, even if the Wet touchscreen profile is selected. The hard-tipped stylus is not supported with the Wet touchscreen profile. Third party styli may work with the SHC6000 touch screen, however, performance may vary.







### **Calibration Tool - Do Not Use**

If the Windows 10 screen calibration tool is used, it may degrade touchscreen performance.

### **Keypad Features**

The SHC6000 has programmable keys, a power/suspend key, windows key, enter key, and a navigation pad.

The keys are sealed and have backlight illumination.

<b>Key</b>	<b>Function</b>
	Windows Start screen
<b>F2</b>	Volume down (programmable)
<b>F1</b>	Volume up (programmable)
	Move left
	Move right
	Move up
	Move down
	Enter (return)
<b>ESC</b>	Escape key (programmable)
	Power <ul style="list-style-type: none"><li>■ Press and release: On or sleep</li><li>■ Hold for 5 seconds and pull down screen: Power off</li><li>■ Hold for 20 seconds: Electrically disconnect the battery pack(s); to reconnect the batteries, you are required to plug in the charger or external 12 V power.</li></ul>



## ***Programmable Keys***

To assign the programmable keys, open the Start menu and select *Keypad* (located at the bottom of the *Start menu* screen in a shortcut tile). The *Keypad Buttons and Backlight* panel appears. The programmable keys and their current assignments are shown. Select your preferred function per key from the drop down menus.

### *Keypad Backlight Brightness*

To adjust the keypad backlight brightness, go to the Start menu and select *Keypad*. At the bottom of the *Keypad Buttons and Backlight* panel is a slider that adjusts the keypad backlight brightness. You can make the backlight brighter by moving the slider to the right or turn it down by moving the slider to the left. Dimming the keypad backlight extends battery life when the SHC6000 is in use.

## **LED Activity Indicators**

LED activity indicators are located on the front of the SHC6000 in the upper-left corner.

- Red LED, solid: 1) When the SHC6000 is put to sleep or powered off by pressing the power key , the red LED is solid until the unit has successfully completed the process, and then the red LED turns off. If powering off the device, do not remove the battery while the light is solid. 2) The AC wall charger is plugged in and the battery is full (not charging).
- Red LED, blinking: The AC wall charger is plugged in and the battery is in the process of charging.
- Green LED, solid: Turns on when the system is booting, programmable.
- Blue LED, solid or blinking: Programmable.
- Amber Light: Front or rear facing camera is in use.

The green and blue LEDs are in the same location. They cannot be shown simultaneously. These LEDs can be programmed by a developer. Sample code is available upon request.

## Light Sensor

All units have an ambient light sensor located on the front of the SHC6000 in the upper-right corner. The light sensor dynamically adjusts the backlight on the display.

You can disable this process and manually control the display brightness if you prefer. Go to the Start menu and select *Settings > System > Display*. Turn off *Change brightness automatically when lighting changes* and tap *Apply*. To manually adjust the display backlight, tap on the battery icon at the bottom of the desktop screen. The display backlight brightness can easily be toggled up or down in 25% increments from 0% to 100% by tapping the percent tile (see the sun icon).

## Connector Ports

The SHC6000 has a 12 VDC power input jack, USB 3.0 Host type A, and a 3.5mm audio jack.

## Connector Protector

The connector protector is removable and replaceable. To remove it, pull it out of the ports, then gently pull the curved rubber retainers out of the holes they are in. Replace it by inserting the curved rubber retainers back into the holes. See your sales representative if you need a new one.

*Note: The connector protector is not required to maintain the seal of the connectors or the SHC6000. The connector protector is intended as a port dust cover*

## SD Cards

The SHC6000 has a slot for a micro SD card located in the battery compartment. The card slot and flexible card holder are designed to hold the card securely in place so it will not come out or disconnect if the SHC6000 is dropped. To insert or remove a card, follow these steps:

1. Power off the SHC6000.
2. Remove the battery door as outlined in Chapter 1.



**CAUTION:** The SHC6000 is not sealed against water and dust when the battery pack and battery door are not installed properly.



**CAUTION:** Always power off the SHC6000 before removing the battery. Failure to do so may cause loss of data or damage to the SHC6000. EXCEPTION: If your SHC6000 has an internal battery, this caution does not apply. You can safely remove the removable battery while the unit is running.

3. Remove the battery pack by pulling up on the black tab on the battery pack.
4. An image on the battery compartment label shows the correct location and orientation for the SD card (slot on the right). Pull the flexible card holder back out of the way. Push the card into the slot to insert it.

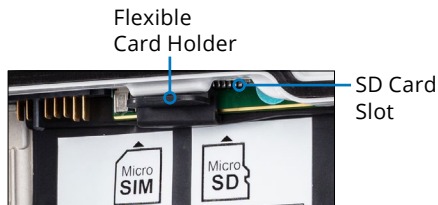

5. Push the flexible card holder back into place, covering the card slots.
6. Replace the battery pack, and attach the battery door.

To remove the SD card, pull it out. Use tape or an eraser if you have trouble.

## Audio Features

The SHC6000 has the following audio features:

- **Speaker** - The speaker provides audible indicators and program feedback. You can listen to mono audio files and watch video. For stereo audio, use *Bluetooth*, headphones or HDMI output from the optional dock.
- **Microphone** - Use the microphones to record audio notes or include sound in a video, using the camera. Built in microphones can also be used for Skype calls.
- **Audio Jack** - The audio jack supports a stereo headset or headset/microphone combination with 3.5 mm connections.



## Sensors

### Compass, Accelerometer, and Gyroscope

The SHC6000 has a built-in compass and accelerometer. The accelerometer assists the compass in determining direction, even when the device is not resting flat. The gyroscope senses change in angular motion. The compass, accelerometer, and gyroscope can also be used by other user applications.

### Compass Calibration

Periodic user calibrations help the compass function in the environment the SHC6000 is being used in.

1. Open an app that uses the compass.
2. Move the SHC6000 around in the air so that it is oriented in different directions and angles. An effective way to assure this is properly done is to move the SHC6000 back and forth in a sideways figure 8 for approximately 30 seconds.



### Bluetooth® Wireless Communication

The SHC6000 has built-in *Bluetooth*® wireless technology, allowing you to connect it to other wireless devices with *Bluetooth* technology.

### Creating a Partnership/Pairing a Bluetooth Device

To create a partnership between the SHC6000 and another device with *Bluetooth* technology:

1. Turn both devices on.
2. Place them within a few feet of each other. (The SHC6000 has long range *Bluetooth*, but the other device might not.)
3. Make *Bluetooth* discoverable on both devices. *Bluetooth* on the SHC6000 is off by default. To activate it, open the Action Center and press and hold the *Bluetooth* icon. Select *Go to settings*.

4. In the *Bluetooth* settings screen, you should see a list of all *Bluetooth* devices within range. Tap on the name of the device in the list you would like to pair with, then tap *Pair*. If prompted, enter the PIN or pass code of the paired device. You should now be paired with the device.

*Note: If Bluetooth is on and the SHC6000 enters sleep or hibernate mode, Bluetooth turns off to save battery power. The connection is resumed once it powers back on.*

## **Wi-Fi Wireless Networking**

The SHC6000 has built-in Wi-Fi wireless networking to connect to the internet or an office network.

### **Connecting to a Wi-Fi Network**

To use Wi-Fi, you need to be in range of a Wi-Fi access point to make a connection. When Wi-Fi is turned on (the default), the SHC6000 automatically starts scanning the area for available Wi-Fi networks.

From the Action Center, click and hold the *Wi-Fi network icon*, then select *go to settings*. A list of available networks is shown. Select the network you want to use and enter the network security key. The SHC6000 remembers the Wi-Fi network connections created.

Wi-Fi can be turned off and on and settings can be managed from this set up screen.

## **GPS/GNSS**

The SHC6000 field computer uses an integrated GPS/GNSS receiver with an internal antenna to provide position information. Use Maps to see your location and ensure that the receiver is working. Open the Start menu and select *Maps*.

### **GPS/GNSS Support**

#### ***Integrated GPS/GNSS Support in Windows***

The Windows operating system provides built-in support for GPS/GNSS devices. As part of that support, the Windows Sensor and Location platform provides a standard way for GPS/GNSS information to be made available to applications that have been designed using the Windows Sensor and Location application programming interfaces (APIs).

## **Legacy Support**

In addition to the Sensor and Location APIs, legacy applications that require access to a serial port can access NMEA data through a serial COM port interface. The name of the COM port can be found by using Device Manager and looking under Ports (COM & LPT) for “u-blox Virtual COM port (COMx)” where “x” is the port number allocated on your device.

## **GPS/GNSS Accuracy**

The GPS/GNSS antenna is at the top under the notification LEDs. It is intended to work in both portrait and landscape view. Do not put your hand or another object over this area. Accuracy may be reduced. The more items between the antenna and the satellites, the lower the accuracy.

## **Camera**

The SHC6000 has a front facing camera that is 2 MP and a rear facing camera that is 8 MP.

You can capture both still images and videos using the camera application. Other options include a timer, flash, and brightness settings.

## **Photo and Video Library**

Photographs and videos are automatically stored in the Pictures folder.

## **Power Management**

The SHC6000 runs on battery power, using a rechargeable, Li-Ion battery pack. The SHC6000 also has an internal battery. The SHC6000 operates on either or both battery packs.

## **Charging the Battery Pack(s)**

For instructions on how to insert and charge the removable battery pack, refer to *Chapter 1, Getting Started*.

For units that have both a removable battery pack and an internal battery pack, the intelligent internal battery charging circuit first charges the battery pack with the least amount of energy. When this battery pack comes to the same level as the other battery pack, then both battery packs are charged at the same time until they are both fully charged.

Battery packs are charged most efficiently at room temperature (68°F or 20°C). They will not charge if it is too hot or too cold.



### **Battery Status and Management**

To find out how much battery life you have left, tap on the battery icon at the bottom of the desktop screen. The amount of charge left as a percent and the status of each battery is shown. The cumulative amount of battery life left for installed batteries and the approximate amount of time battery power will last is also shown. The amount of time left varies depending on what you are doing with the unit.

### **Battery Life**

Battery life on a full charge can be 18 hours or more. This varies depending on the applications used, backlight usage, and radio usage.

The shelf life for battery packs is about one year. The battery packs should be recharged at least once per year. This prevents the battery packs from discharging to a level that might damage the batteries. Battery packs that are not recharged at least every year, could fail to work or may have reduced capacity. Battery packs typically last 1,000 to 3,000 charging cycles.

-  **CAUTION:** Only use batteries designed for the SHC6000 from an approved vendor. Use of non-approved batteries may void your product warranty. The SHC6000 must be returned to the factory for replacement of the internal battery.
-  **CAUTION:** The unit is not designed to run on external power without a battery installed. Doing so can damage internal components of your unit and void the warranty.

## Powering Off the SHC6000

### **Short-term Storage**

When you plug the SHC6000 into the wall charger that comes with it, the batteries are prevented from being overcharged.

Charge the SHC6000 to 50-70% then power it off:

1. Press and hold the power button for 2-3 seconds.
2. A message is shown asking you to slide the screen down to shut down your device.

### **Long-term Storage**

To power off the SHC6000 for long-term storage, follow these steps:

1. Power off the SHC6000 as described in the previous section, *Short-term Storage*.
2. Press and hold the power button for 20 seconds. This disconnects the batteries from the system.
3. Take out the removable battery and store it in a cool, dry location.
4. When you are ready to power on the SHC6000, replace the battery pack. Plug in the AC wall charger and connect it to the SHC6000 BEFORE you power it on.

### **Ctrl-Alt-Delete Function**

Press and hold down the windows key, then press the power key. A list that includes the *Task Manager* is shown. Select *Task Manager* to see which apps are running. Press *More details* at the bottom to view *Processes*, *Performance*, and other items. This can be useful for troubleshooting.

### **SHC6000 is Locked Up**

If the SHC6000 is completely stuck and won't respond or you cannot get to the Start menu, hold the power key down for five seconds to see if that solves it. If that doesn't work, hold it down for 10 seconds. This causes a hardware shut off. Press the power button again to power it on.

If 10 seconds doesn't work, hold the power button down for 20 seconds. Batteries are forced to electrically disconnect from the SHC6000, causing a complete shut down. The SHC6000 cannot be powered on again until it is plugged in with the AC wall charger. Keep this in mind if you are in the field.

 **CAUTION:** Holding the power button down for 20 seconds for a forced disconnect is recommended only as a last resort. Forcing the power off causes all unsaved data to be lost and corrupts active data transfers to storage.

# 3

## Optional Features and Accessories



# Optional Features and Accessories

This chapter discusses the optional features that can be included with the SHC6000.

## 4G LTE Data Modem

The 4G LTE data modem is an option for the SHC6000, adding Wireless Wide Area Network data modem capability.

This modem supports all major service providers in North America, Europe, and many other regions of the world.

### Set up a Data Account with a Wireless Provider

Contact a wireless provider to set up data service for the cellular data modem and obtain an account and micro SIM card. You need to provide the following information when setting up an account:

1. Billing Information and business ID, such as your Federal Tax ID or VAT number.
2. The wireless services required. Specify that you need data service only. You do not need voice or messaging services.
3. You may be asked for the modem's IMEI number. From the Start menu, select *Settings > Network & Internet > Cellular*. Tap on the Cellular icon, then select *Advanced Options*. The IMEI number is listed under *Properties*.

### Install the SIM Card

The card slot and flexible card holder are designed to hold the card securely in place so it will not come out or disconnect if the SHC6000 is dropped. To insert or remove a card, follow these steps:

1. You must power off the SHC6000.
2. Remove the battery door as outlined in Chapter 1.



**CAUTION:** The SHC6000 is not sealed against water and dust when the battery door is not installed properly.

3. Remove the battery pack by pulling up on the black tab on the front of the battery pack.



- An image on the battery compartment label shows the correct location and orientation for the SIM card (slot on the left). Pull the flexible card holder back out of the way. Push the card into the slot to insert it.

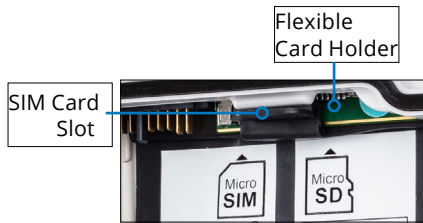

- Push the flexible card holder back into place, covering the card slots.
- Replace the battery pack, and attach the battery door.

To remove the SIM card, gently pull it out with tweezers or a piece of tape.

*Note: If the modem was on before shutting the SHC6000 down to insert the SIM card, you are prompted to configure the data connection when you reboot.*

## Office Docking Station

The Office Docking Station enables you to perform the following functions:

- Charge your SHC6000
- Use your SHC6000 as a desktop computer
- Transfer data to or from another computer or network via the Ethernet connection

## Dock Features

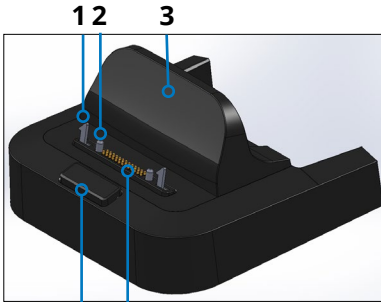

- 1 Lock Latch (2)
- 2 Alignment Pin (2)
- 3 Back Rest
- 4 Release Button
- 5 Pogo Pins
- 6 USB Ports, Host (3)
- 7 HDMI Port
- 8 Ethernet Port
- 9 Power Input Jack



6 7 8 9

## Ports

- The USB ports are for attaching devices to the SHC6000 such as a mouse, keyboard, or external storage device.
- The HDMI port is for connecting a video monitor to the SHC6000, giving you a second monitor.
- The Ethernet port is used for networking (an Ethernet cable is not included).

## How to Use the Dock

1. Provide power to the dock using the 30 W AC wall charger provided with your SHC6000. A 45 W charger is available as an option, and we recommend this charger if you are using the dock as an office computer with several peripheral functions. The 30 W AC wall charger might not provide enough power to charge the batteries and run the SHC6000.
2. Plug in the cables for your desired setup.
3. If a hand strap is covering the pin contacts on the SHC6000, unhook one end or remove it.

4. Hold the SHC6000 horizontally with the docking pin contacts facing down. Place it over the dock alignment pins and press down until you feel and hear the lock engage.
5. The SHC6000 charges more quickly if the power settings are set up to allow the SHC6000 to enter a low power mode when it is not in use, but is plugged in. To adjust this setting, go to the Start menu, then *Settings > System > Power & sleep*.

### **Mounting the Dock to a Surface**

The Office Docking Station is freestanding. It can also be mounted to a surface like a desk or shelf. There are keyhole slots on the bottom for this purpose.

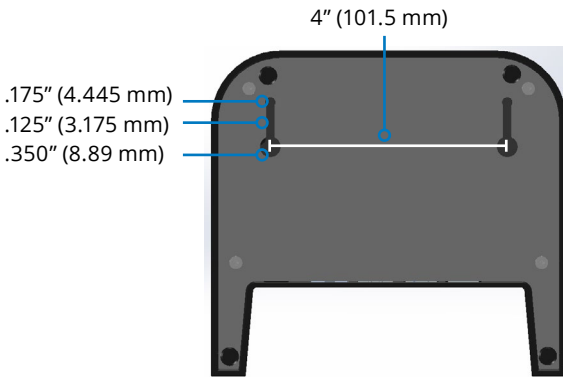

### **Ethernet Specifications**

- 10/100/1000 Mbps twisted-pair Ethernet
- IEEE802.3/802.3u/802.3ab 10BASE-T, 100BASE-TX, and 1000BASE-T
- Manages twisted pair crossover detection and correction
- Full-duplex and half-duplex capability (only full-duplex operation at 1000 Mbps)

### **Maintenance and Environmental Issues**

- The dock is intended for indoor use only.
- Temperatures should be between 0°C to 50°C.
- Avoid using the dock in situations where water can enter the connector ports. It is not sealed against water and must be kept dry.

- Do not touch the docking pins (spring loaded contacts) with conductive items when power is applied to the dock.
- Do not drop items on the dock that can damage the pins.
- Keep debris off of the docking pins.

## **Battery Charger**

The Battery Charger is an optional accessory, allowing you to charge spare battery packs for the SHC6000.

### **How to Use the Battery Charger**

Batteries charge best at room temperature (about 68°F or 20°C). Batteries will not charge (or might charge slowly) at temperatures below 32°F (0°C) or above 122°F (50°C).

Power the Battery Charger by using the AC wall charger provided with your SHC6000. Slide the battery pack into the battery charger, orienting it so that the battery contacts meet the charging contacts in the battery charger. The red LED flashes slowly, indicating that the battery pack is charging.

### **LED Indicator**

The LED indicates the charging status:

- Solid, on: The battery pack is fully charged.
- Blinking (slow): The battery pack is charging.
- Off: There is no power. The battery is not charging.

# A

## Storage, Maintenance, and Recycling



**SOKKIA**

# Storage, Maintenance, and Recycling

Follow the instructions in this chapter to properly maintain and recycle the SHC6000.

## Storing the SHC6000 and Battery Pack

When the SHC6000 is not being charged and is in a sleep state, it draws a small amount of power. This power draw is used to maintain the memory (RAM) of the SHC6000 in the same state it was in when it was awake. We recommend charging the SHC6000 each night or weekend when it is in a sleep state.

If the SHC6000 is not charged while in a sleep state and the battery reaches a low charge, it automatically hibernates to prevent further drain on the battery.

*Note: Data and programs are secure as long as they have been saved, even if the battery pack becomes discharged. The SHC6000 does not depend on the battery to store the data for extended periods.*

## Storing the SHC6000 for More than Two Weeks

To store the SHC6000 for two weeks or more, complete the following steps:

1. Charge the battery pack 30 to 50 percent.
2. Close all running programs, and turn off the SHC6000.
3. Remove the battery pack.
4. If you have an internal battery pack, press and hold the power button for 20 seconds to disconnect it.
5. Place the battery pack in a cool, dry location.
6. The AC wall charger must be plugged in and connected to the SHC6000 in order to turn it on after storage.

## Protecting the Touchscreen

Protect the touchscreen from impact, pressure, or abrasive substances that could damage it. To further protect the touchscreen, apply a screen protector (optional accessory) using the directions that come with it in the package.



**CAUTION:** Be sure to replace the screen protector as often as the screen protector instructions recommend.

## Cleaning the SHC6000

Make sure the battery door is securely installed. Remove the screen protector if you want to clean underneath it. Use warm water, a mild cleaning solution, and a soft bristle brush to gently clean the SHC6000.

**ⓘ CAUTION:** Do not direct a high-pressure stream of water at the device to clean it. This action could break the seal, causing water to get inside the device and voiding the warranty.

**ⓘ CAUTION:** Exposure to some cleaning solutions may damage your device, including automotive brake cleaner, isopropyl alcohol, carburetor cleaner, and similar solutions. If you are uncertain about the strength or effect of a cleaner, apply a small amount to a less visible location as a test. If any visual change becomes apparent, promptly rinse and wash with a known mild cleaning solution or with water.

## Recycling the SHC6000 and Batteries

When the SHC6000 and Li-Ion battery packs for your SHC6000 reach the end of their service life, they must not be disposed of with municipal waste. It is your responsibility to dispose of your waste equipment by handing it over to a designated collection point for the recycling of waste electrical and electronic equipment.





# B

## Warranty and Repair Information



**SOKKIA**

# Warranty and Repair Information

## Limited Product Warranty

### Two Year Warranty

Sokkia Corporation USA ("SC") warrants that the SHC6000 field computer and internal battery shall be free from defects in materials and workmanship, under normal intended use, for a period of 24 months from the date of shipment, excepting that this warranty shall not apply to user replaceable battery packs, media containing SHC6000 and desktop PC programs, user documentation, and any accessories.

### Ninety Day Warranty

SC warrants that the following items shall be free from defects in materials and workmanship, under normal intended use, for a period of ninety (90) days from the date of shipment:

- User replaceable battery packs
- Media containing SHC6000 and desktop computer programs
- User documentation
- Accessories

### Warranty Exclusions

This warranty shall not apply if:

- (i) the product has been set up improperly or has been improperly installed or calibrated,
- (ii) the product is operated in a manner that is not in accordance with the user documentation,
- (iii) the product is used for a purpose other than for which it was designed,
- (iv) the product has been used in environmental conditions outside of those specified for the product,
- (v) the product has been subject to any modification, alteration, or change by or on behalf of customer (except and unless modified, changed or altered by SC or under direct supervision of SC),

- (vi) the defect or malfunction results from misuse or accident,
- (vii) the serial number on the product has been tampered with or removed, or
- (viii) the product has been opened or tampered with in any way (such as the tamper evident VOID label indicating certified IP [Ingress Protection] seal area has been tampered with or removed).

Parts that are excessively worn are not covered under warranty. These may include, but are not limited to, the keyboard elastomer and switch matrix, hand straps, and the touch screen (if applicable).

This warranty is exclusive and SC will not assume and hereby expressly disclaims any further warranties, whether express or implied, including, without limitation, any warranty as to merchantability, fitness for a particular purpose, non-infringement or any warranties arising from the course of performance, dealing, or usage of trade. SC specifically makes no warranties as to the suitability of its products for any particular application. SC makes no warranties that

- its products will meet your requirements or will work in combination with any hardware or applications software products provided by third parties,
- the operation of its products will be uninterrupted or error free, or
- all defects in the product will be corrected.

SC shall not be responsible for software, firmware, information, or memory data contained in, stored on, or integrated with any products returned to SC for repair, whether under warranty or not.

## **Remedy**

In the event a defect in materials or workmanship is discovered and reported to SC within the specified warranty period, after evaluation by a technician at a certified repair center, SC will, at its option, repair the defect or replace the defective part or product. Replacement products may be new or reconditioned.

SC warrants any replaced or repaired product for a period of ninety (90) days from the date of return shipment, or through the end of the original warranty period, whichever is longer.

### **Limitation of Liability**

To the fullest extent allowed by law, the obligation of SC shall be limited to the repair or replacement of the product. SC shall in no event be liable for special, incidental, or consequential, indirect, special or punitive damages of any kind, or for loss of revenue or profits, loss of business, loss of information or data, or other financial loss arising out of or in connection with the sale, installation, maintenance, use, performance, failure, or interruption of any product. Any responsibility and/or liability of SC shall, in connection with a warranted product, be limited in the maximum amount to the original purchase price.

### **Governing Law**

This warranty is governed by the laws of California, U.S.A. and excludes the United Nations Convention on Contracts for the International Sale of Goods. The courts of California shall have exclusive personal jurisdiction in case of any disputes arising out of or in connection with this warranty.

### **Warranty Repairs**

To obtain warranty repair or service on the the SHC6000 field computer, submit a repair order on our website at <https://us.sokkia.com/sokkia-care> or contact an authorized repair center within the applicable warranty period. Products returned for a repair or service without proper authorization may acquire an additional handling fee and/or delay in the repair. The customer is responsible to prepay all shipping costs when sending equipment to a repair center. The repair center will return the repaired equipment by the same method it was received with costs of shipping prepaid.

### ***Services and Materials Provided Under Warranty***

- Analysis of problem by service technician
- Labor and materials required to fix defective parts
- Functional analysis performed after repair
- Shipping costs to return device to customer

## Complete Care Service Plans

We offer service plan options that provide additional benefits through participating repair centers. Services include:

- Service plan coverage up to five years from the original product ship date
- Up to a 50% discount on all charged repairs
- Expedited repairs and return shipping at no additional charge
- Replacement of worn and/or damaged parts at no additional charge
- Complete comprehensive coverage to protect your investment even when accidents occur
- Loaner product option when an expedited repair is not enough
- Priority support through a personal account specialist

For more information about our Complete Care service plans, go to our website at <https://us.sokkia.com/sokkia-care>.

## Repairs, Upgrades, and Evaluations



**CAUTION:** Do not attempt to repair the SHC6000 yourself. This action voids the warranty.

Information about repairs, upgrades, and evaluations is located on our website at <https://us.sokkia.com/sokkia-care>. You can locate a repair center, submit a repair order, check repair status, view terms and conditions, get shipping instructions, and view lead times.

Before returning a unit, please get permission by submitting a repair order from our website and waiting for confirmation or by contacting a repair center directly. Be prepared to provide the following information:

- The product serial number. Information about your SHC6000 is shown when you go to the Start menu and select *Device Info*. The serial number is located inside the battery compartment as well.

*Note: Before opening the battery door and removing the battery, see the proper procedure in Chapter 2, Power Management.*

- Name and shipping address of company/university/agency.
- Best contact method (phone, fax, email, cell/mobile).
- Clear, highly-detailed description of the repair or upgrade.
- Credit card/purchase order number and billing address (for a repair or upgrade that is not covered by the standard warranty or an extended warranty policy).

### **System Information for your SHC6000**

You might be asked to provide additional information about your SHC6000 when you contact a repair center. To view information like the operating system edition, OS build and serial number, go to the Start Menu and select *Device Info*. You can find additional information under Action Center and select *All Settings > System > About*.

C

# Warnings, Regulatory Information, Licensing



**SOKKIA**

# Warnings, Regulatory Information, Licensing

## Product Warnings

Follow the warnings listed below to use the SHC6000 and accessories safely.



### Battery Warnings

**WARNING!** This device comes with a lithium-ion rechargeable battery pack. To reduce the risk of fire or burns, do not disassemble, crush, puncture, short external contacts, or expose the battery pack to fire.

Do not disassemble or open, crush, bend or deform, puncture or shred.

Do not modify or remanufacture, attempt to insert foreign objects into the battery, immerse or expose to water or other liquids, expose to fire, explosion or other hazard.

Only use the battery for the system for which it is specified.

Only use the battery with a charging system that has been qualified with the system per this standard. Use of an unqualified battery or charger may present a risk of fire, explosion, leakage, or other hazard.

Do not short circuit a battery or allow metallic conductive objects to contact battery terminals.

Replace the battery only with another battery that has been qualified with the system.

Use of an unqualified battery may present a risk of fire, explosion, leakage, or other hazard.

Promptly dispose of used batteries in accordance with local regulations.

Battery usage by children should be supervised.

Avoid dropping the battery. If the battery is dropped, especially on a hard surface, and the user suspects damage, take it to a service center for inspection.



Improper battery use may result in a fire, explosion or other hazard.



**CAUTION:** Risk of explosion if the battery is replaced by an incorrect type.



### **Wall Charger Warnings**

**WARNING!** To reduce the risk of personal injury, electrical shock, fire or damage to the equipment:

Plug the wall charger into an electrical outlet that is easily accessible at all times.

Do not place anything on the wall charger cord or any of the other cables. Arrange them so that no one may accidentally step on or trip over them.

Do not pull on a cord or cable. When unplugging the wall charger from the electrical outlet, pull on the plug, not the cord.

The AC wall charger must be approved by Sokkia, have an output rating of 12 VDC and a minimum 1.67 A, and be certified or listed by a nationally recognized testing laboratory. The AC wall charger provided with the SHC6000 meets these criteria. Using any other external power source can damage your product and void your warranty.

## Certifications and Standards

There are North American, European Union, and Australian versions of the SHC6000, with different certifications and standards.

### United States

In compliance with the FCC rules 47 CFR 15.19(a)(3), the statements that follow must appear on the device or in the user documentation.

This device complies with Part 15 of the FCC Rules. Operation is subject to the following two conditions:

- The device may not cause harmful interference.
- This device must accept any interference received, including interference that may cause undesired operation.

In compliance with the FCC rules, 47 CFR 15.105(b), the user must be notified that this equipment has been tested and found to comply with the limits for a Class B digital device, pursuant to part 15 of the FCC Rules. These limits are designed to provide reasonable protection against harmful interference in a residential installation. This equipment generates, uses and can radiate radio frequency energy and, if not installed and used in accordance with the instructions, may cause harmful interference to radio communications. However, there is no guarantee that interference will not occur in a particular installation. If this equipment does cause harmful interference to radio or television reception, which can be determined by turning the equipment off and on, the user is encouraged to try to correct the interference by one or more of the following measures:

- Reorient or relocate the receiving antenna.
- Increase the separation between the equipment and receiver.
- Connect the equipment into an outlet on a circuit different from that to which the receiver is connected.
- Consult the dealer or an experienced radio/TV technician for help.

In compliance with the FCC rules, 47 CFR 15.21, the user must be notified that changes or modifications to the SHC6000 that are not expressly approved by the manufacturer could void the user's authority to operate the equipment.

Only approved accessories may be used with this equipment. In general, all cables must be high quality, shielded, correctly terminated, and normally restricted to two meters in length. Wall chargers approved for this product employ special provisions to avoid radio interference and should not be altered or substituted.

## **Canada**

In compliance with Industry Canada rules, the following statement must appear on the device or in the user documentation:

This Class B digital apparatus complies with Canadian ICES-003.

This device complies with Industry Canada licence-exempt RSS standard(s). Operation is subject to the following two conditions: (1) this device may not cause interference, and (2) this device must accept any interference, including interference that may cause undesired operation of the device.

Canadian regulations restrict the use of channels in the band 5150 MHz to 5250 MHz to indoor use only. When this product is connected with an access point that is operating in this frequency range, or when using ad-hoc mode, the use of this product is restricted to indoor use only.

Le présent appareil est conforme aux CNR d'Industrie Canada applicables aux appareils radio exempts de licence. L'exploitation est autorisée aux deux conditions suivantes: (1) l'appareil ne doit pas produire de brouillage, et (2) l'utilisateur de l'appareil doit accepter tout brouillage radioélectrique subi, même si le brouillage est susceptible d'en compromettre le fonctionnement.

La réglementation canadienne restreignent l'utilisation des canaux dans la bande 5150 MHz à 5250 MHz pour une utilisation en intérieur. Lorsque ce produit est connecté à un point d'accès qui fonctionne dans cette gamme de fréquences, ou lorsque vous utilisez le mode ad-hoc, l'utilisation de ce produit est limitée à une utilisation en intérieur.

### **Radio Frequency Safety**

This equipment complies with radiation exposure limits set forth for an uncontrolled environment. This equipment is in direct contact with the body of the user under normal operating conditions. This transmitter must not be co-located or operating in conjunction with any other antenna or transmitter.

Cet équipement est conforme aux limites d'exposition aux radiations dans un environnement non contrôlé. Cet équipement est en contact direct avec le corps de l'utilisateur dans des conditions de fonctionnement normales. Cet émetteur ne doit pas être co-localisées ou opérant en conjonction avec tout autre antenne ou transmetteur.

### **CE Marking (European Union)**



Products bearing the CE marking comply with the EU Directive 2014/53/EU.

CE compliance of this device is valid only if powered with/by a CE-marked wall charger provided by the manufacturer. Cables connecting to the USB host port must use a ferrite core/bead on the cable. The ferrite core must be placed on the cable near the end that connects to the SHC6000.

## **Declaration of Conformity**

The Declaration of Conformity for CE Marking is available at:  
<https://us.sokkia.com/sokkia-care>

## **Restricted Materials Conformity**

The SHC6000 conforms to the following restricted materials regulations:

- RoHS 2011/65/EU
- RoHS 2015/863
- REACH 1907/2006 (33)
- REACH 1907/2006 (67)
- POP 2019/1021
- Proposition 65
- Canada Prohibition
- TSCA

## **Licensing Information**

This Product is licensed under the AVC, the VC-1 and the MPEG-4 Part 2 Visual patent portfolio licenses for the personal and non-commercial use of a consumer to (i) encode video in compliance with the above standards (“Video Standards”) and/or (ii) decode AVC, VC-1 and MPEG-4 Part 2 Visual that was encoded by a consumer engaged in personal and non-commercial activity or was obtained from a video provider licensed to provide such video. None of the licenses extend to any other product regardless of whether such product is included with this product in a single article. No license is granted or will be implied for any other use. Additional information may be obtained from MPEG LA, LLC. See [www.mpegla.com](http://www.mpegla.com).

No rights are given for Dolby patents used in the Dolby portion of this product. A list of relevant patents may be obtained from Dolby Laboratories, Inc. No rights are granted to any Dolby copyrights, including the right to reproduce or distribute any portions of this product that includes Dolby intellectual property. Licenses for these activities may be obtained from Dolby.

Any use of this product in any manner other than personal use that complies with the MPEG-2 standard for encoding video information for packaged media is expressly prohibited without a license under applicable patents in the MPEG-2 patent portfolio, which license is available from MPEG LA, LLC, 6312 S. Fiddlers Green Circle, Suite 400E, Greenwood Village, Colorado 80111 U.S.A.

Windows 10 is automatically updated, which is always enabled. ISP fees may apply. Additional requirements may apply over time for updates.

Cortana experience may vary by device.

# D

## Specifications



**SOKKIA**

# SHC6000 Field Computer Specifications

*Note: Specifications are subject to change without notice.*

FEATURE	SPECIFICATION
Operating System	<ul style="list-style-type: none"><li>■ Microsoft® Windows 10 Pro or Windows 10 IoT Enterprise</li><li>■ English, French, German, Spanish, Brazilian Portuguese are built in; other languages are available for download</li></ul>
Processor	<ul style="list-style-type: none"><li>■ Quad-core Intel® Pentium® N4200</li></ul>
Memory	<ul style="list-style-type: none"><li>■ 8 GB RAM (LPDDR4)</li></ul>
Primary Data Storage	<ul style="list-style-type: none"><li>■ 128 GB or 256 GB flash storage (model specific)</li></ul>
Micro SD/SDXC Card Slot	<ul style="list-style-type: none"><li>■ SD/SDXC slot, user accessible</li></ul>
Physical Features	<ul style="list-style-type: none"><li>■ Dimensions, standard: 5,4" wide x 8.48" long x 1.36" thick (137 mm x 215 mm x 35 mm)</li><li>■ Weight: 1.5 to 2.2 lb (680-907 g) depending on battery configuration and internal options installed</li><li>■ Durable, chemical- and shock-resistant design</li><li>■ Easy-to-grip, impact-absorbing, overmolded bumpers</li><li>■ 3 mounting points on the back are size #4-40 UNC with a maximum depth of 3/16th" (4.76 mm)</li></ul>
Display	<ul style="list-style-type: none"><li>■ Active viewing area: 7" (178 mm)</li><li>■ WXGA 800 x 1280 pixel resolution</li><li>■ Backlit LCD</li><li>■ Outdoor viewable</li><li>■ Portrait or landscape orientation</li></ul>



FEATURE	SPECIFICATION
Touchscreen	<ul style="list-style-type: none"> <li>■ Capacitive multi-touch interface for use with gloves, small tip stylus, and in wet conditions</li> <li>■ Chemically-strengthened Dragontrail™ High Ion-Exchange (HIE™) coverglass for impact and scratch resistance</li> <li>■ Touchscreen profile options</li> </ul>
Keyboard	<ul style="list-style-type: none"> <li>■ Programmable keys</li> <li>■ Backlit keys</li> </ul>
Batteries	<ul style="list-style-type: none"> <li>■ Rechargeable Li-Ion battery pack, 7.2 VDC 6Ah, 43.2 Whr</li> <li>■ Run time of up to 12 hours or more</li> <li>■ Charging time 4 to 6 hours</li> <li>■ Built-in battery intelligence</li> <li>■ User-replaceable</li> <li>■ Internal 21.6 Whr battery provides an additional 50% of runtime and hot-swap capability; not user replaceable (not user accessible)</li> </ul>
Connector Ports	<ul style="list-style-type: none"> <li>■ USB 3.0 Host (full size A connector)</li> <li>■ Power input is 10 V - 15.5 V, nominal 12 VDC</li> <li>■ 3.5 mm audio jack, supports stereo headset/microphone</li> </ul>
Wireless Connectivity	<ul style="list-style-type: none"> <li>■ <i>Bluetooth</i>® wireless technology 5.0 long range</li> <li>■ Wi-Fi 802.11 a/b/g/n/ac 2.4 GHz and 5 GHz</li> </ul>
Audio	<ul style="list-style-type: none"> <li>■ Mono speaker, loud and clear</li> <li>■ Microphone, low noise</li> </ul>
LED Activity Indicators	<ul style="list-style-type: none"> <li>■ Red: power applied/charging status</li> <li>■ Green: system is booting</li> <li>■ Blue: application programmable</li> <li>■ Amber Light: front or rear facing camera is in use</li> </ul>

FEATURE	SPECIFICATION
Standard Sensors/ Features	<ul style="list-style-type: none"> <li>■ Ambient light sensor</li> <li>■ Compass</li> <li>■ Accelerometer</li> <li>■ Gyroscope</li> <li>■ TPM (Trusted Platform Module) v2.0</li> </ul>
Temperature Specifications	<ul style="list-style-type: none"> <li>■ Operating Temperature: -4°F to 122°F (-20°C to 50°C). Storage Temperature: -22°F to 158°F (-30°C to 70°C)</li> <li>■ Battery Charging Temperature: 32°F to 122°F (0°C to 50°C)</li> </ul>
Shock Resistance	<ul style="list-style-type: none"> <li>■ Withstands multiple 4 foot drops to concrete</li> </ul>
Environmental Ratings and Standards	<ul style="list-style-type: none"> <li>■ IP68 rating (1.4 meters for 2 hours), waterproof and dustproof</li> <li>■ Designed to MIL-STD810G. Tests: ME-60: sand &amp; dust ME-51,53,&amp; 54: X,Y,&amp; Z-axis helicopter vibe ME-55, 56, &amp; 57: X, Y, &amp; Z -axis general vibe ME-52: Water Immersion, 1 meter ME-59: Aggravated Temperature-Humidity cycle ME-67: Temperature cycle ME-62: Temperature shock ME-66: Altitude</li> </ul>
Certifications and Standards	<ul style="list-style-type: none"> <li>■ FCC Class B</li> <li>■ CE Marking</li> <li>■ Industry Canada</li> <li>■ Australia (ACMA)</li> <li>■ <i>Bluetooth</i> SIG qualification</li> <li>■ IP68 waterproof and dustproof</li> <li>■ Designed to MIL-STD 810G</li> <li>■ RoHS 2 compliant</li> <li>■ SHC6000 is certified on AT&amp;T networks</li> </ul>

FEATURE	SPECIFICATION
Warranties	<ul style="list-style-type: none"> <li>■ 24 months for SHC6000</li> <li>■ 90 days for accessories</li> <li>■ Extended service and maintenance plans</li> </ul>
Software Included	<ul style="list-style-type: none"> <li>■ Alarms &amp; Clock</li> <li>■ Calculator</li> <li>■ Calendar</li> <li>■ Camera</li> <li>■ Cortana</li> <li>■ Device Info (config/control)</li> <li>■ File Explorer</li> <li>■ Groove Music</li> <li>■ Keypad (config/control)</li> <li>■ Magnifier</li> <li>■ Mail</li> <li>■ Maps</li> <li>■ Messaging</li> <li>■ Microsoft Edge</li> <li>■ Narrator</li> <li>■ OneNote</li> <li>■ Photos</li> <li>■ Snipping Tool</li> <li>■ Sticky Notes</li> <li>■ Store</li> <li>■ Task Manager</li> <li>■ Touchscreen Profiles (config/control)</li> <li>■ Voice Recorder</li> <li>■ Windows PowerShell</li> <li>■ Windows Speech Recognition</li> </ul> <p><i>Software on individual units may vary from list based on the model</i></p>

FEATURE	SPECIFICATION
Configurations	<ul style="list-style-type: none"> <li>■ Standard features: Wi-Fi, long range <i>Bluetooth</i> wireless technology, 8 GB RAM, 128 GB flash storage, front and rear cameras and a GNSS receiver with internal antenna</li> <li>■ Optional features: 4G LTE data modem and 256 GB flash storage</li> </ul> <p>These are configured for United States/ Canada, European Union or Australia.</p>
Camera	<ul style="list-style-type: none"> <li>■ Resolution: 8 MP rear, 2 MP front</li> <li>■ Auto focus</li> <li>■ Video capture</li> <li>■ JPEG image format</li> <li>■ Flash</li> </ul>
4G LTE Data Modem (option)	<ul style="list-style-type: none"> <li>■ Sierra Wireless AirPrime EM7455 or EM7430 (region dependant)</li> <li>■ Supports micro-SIM card only. Micro-SIM card header inside battery compartment with card detect feature and card retainer.</li> <li>■ Does not support voice calls or SMS</li> <li>■ Supports 3G UMTS, HSUPA, HSDPA, HSPA, HSPA+, WCDMA, LTE</li> </ul> <p><i>* See more details at the end of this chapter</i></p>
GPS/GNSS	<ul style="list-style-type: none"> <li>■ 2 to 5 meter typical accuracy</li> <li>■ u-blox NEO-M8N GNSS receiver and integrated antenna</li> <li>■ Integrated real-time SBAS receiver (WAAS, EGNOS, etc.)</li> <li>■ 72 GNSS tracking channels</li> </ul>
Standard Accessories	<ul style="list-style-type: none"> <li>■ FC/SHC5000/6000 Adjustable Hand Strap (<i>PN 1013589-01</i>)</li> <li>■ AC wall charger w/international plug kit <ul style="list-style-type: none"> <li>- Input: 100-240 VAC, 50/60 Hz, 0.8 A</li> <li>- Output: 12 VDC, 2.5 A</li> </ul> </li> <li>■ Capacitive fine tip stylus with tether</li> <li>■ Quick Start Guide</li> <li>■ Owner's Manual (on our website)</li> <li>■ Two year warranty on SHC6000</li> </ul>

FEATURE	SPECIFICATION
Optional Accessories	<ul style="list-style-type: none"> <li>■ FC/SHC5000/6000 Grounded Stylus (PN 1028985-01)</li> <li>■ FC/SHC5000/6000 Keyboard (Landscape) (PN 1029734-01)</li> <li>■ FC/SHC5000/6000 RAM CLIP Mount Kit (PN 1015317-01)</li> <li>■ FC/SHC5000/6000 RAM CLIP Only (PN 1015316-01)</li> <li>■ FC/SHC5000/6000 Cradle w/Pole Claw (PN 1013399-01)</li> <li>■ SHC5000/6000 RAM 2 7/16" DIA.BASE w/1" BALL (PN B108)</li> <li>■ FC/SHC5000/6000 Ultra-Clear Screen Protector (PN 1013584-01)</li> <li>■ FC/SHC5000/6000 Anti-Glare Screen Protector (PN 1013586-01)</li> <li>■ FC/SHC5000/6000 Polarized Screen Protector (PN 1013587-01)</li> <li>■ FC/SHC5000/6000 Adjustable Shoulder Strap (PN 1013588-01)</li> <li>■ FC/SHC5000/6000 Adjustable Hand Strap (PN 1013589-01)</li> <li>■ FC/SHC5000/6000 Stylus, Tether Replacement (PN 1013590-01)</li> <li>■ FC/SHC5000/6000 Docking Station (PN 1013592-01)</li> <li>■ FC/SHC5000/6000 Travel Charger (PN 1013593-01)</li> <li>■ FC/SHC5000/6000 Vehicle Charger Cable (PN 1018399-01)</li> <li>■ FC/SHC5000/6000 Holster Carrying Case (PN 1018400-01)</li> <li>■ FC/SHC5000/6000 Flip Cover Fitted Case (PN 1018401-01)</li> </ul>

FEATURE	SPECIFICATION
Optional Accessories (continued)	<ul style="list-style-type: none"> <li>■ FC/SHC5000/6000 4-Point Harness (PN 1018402-01)</li> <li>■ Hard Carrying Case for FC/SHC5000/6000 (PN 1026489-01)</li> <li>■ Soft Carrying Case for FC/SHC5000/6000 (PN 1026490-01)</li> <li>■ FC/SHC6000 Removable Battery Pack (PN 1035028-01)</li> <li>■ FC/SHC6000 Travel Charger Assembly (PN 1035030-01)</li> </ul>

**\* 4G LTE Data Modem - Additional Information**

Mode	Model/Region	Frequency Bands
LTE	North America/EU/ROW	B1, B2, B3, B4, B5, B7, B8, B12, B13, B20, B25, B26, B29, B41
"	Australia	B1, B3, B5, B7, B8, B18, B19, B21, B28, B38, B39, B40, B41
UMTS/HSPA+	North America/EU/ROW	B1, B2, B3, B4, B5, B8
"	Australia	B1, B5, B6, B8, B9, B19

Note: ROW = Rest of World, or Non-North America

# Index



**SOKKIA**

# Index

## Symbols

- 4G Data Modem
  - Data Account, Set up With Wireless Provider 20
  - SIM Card Installation 20

## A

- Accessories
  - Optional 49, 50
  - Standard 48
- AC Wall Charger 5, 37
- Anatomy of the SHC6000 2-3
- Audio Features 12
  - Audio Jack 12
  - Microphone 12
  - Speaker 12

## B

- Battery Compartment 3, 4
- Battery Door 2-3
- Battery Pack, Internal 16-17
- Battery Pack, Removable 3-5, 16-18
- Battery Packs
  - Battery Life 16
  - Charge 5, 16, 37
  - Install 4-5
  - Internal 2, 16-17
  - Removable 3, 4
  - Specifications 45
  - Status 16
  - Storage 26
  - Warnings 36
- Bluetooth Wireless Communication 13-14

## C

- Camera 15
  - Specifications 48
- Care and Maintenance
  - Cleaning 27
  - Storage 26



- Cautions 11, 20, 26, 27, 33, 37
- Certifications and Standards 38
  - Canada 39
  - CE Marking, European Union 40
  - Licensing Information 40
  - Radio Frequency Safety 40
  - United States 38
- Cleaning 27
- Compass 13
  - Compass Calibration 13
- Configurations 48
- Connector Ports 3, 12
- Ctrl-Alt-Delete Function 17
  - Task Manager 17

## D

- Data Modem 20
  - Set up a Data Account 20
  - Install the SIM Card 20
- Data Storage 44
- Declaration of Conformity 40
- Display and Touchscreen 8
  - Backlight 8
- Dock. *See* Office Docking Station or Vehicle Dock
- Documentation 4

## E

- Environmental Ratings and Standards 46

## F

- Features
  - Optional 20
  - Standard 8

## G

- GPS/GNSS 48

## H

- Hand Strap 6

## **K**

### Keypad

- Backlight Brightness 10
- Key Functions 9
- Programmable Keys 10

## **L**

- LED Activity Indicators 10
- Light Sensor 11
- Limitation of Liability 32
- Locked Up 18

## **M**

- Memory 44
- Microphone 12, 45

## **O**

- Office Docking Station 21
- Operating System 44

## **P**

- Physical Features 44
- Powering Off 17
- Product Warnings 36

## **R**

- Recycling the SHC6000 and Batteries 27
- Removable Battery Pack 3–5
- Repair 33
  - System Information 34
- Repairs, Upgrades, and Evaluations 33

## **S**

- SD Cards 11
- Sensors
  - Accelerometer 13
  - Compass
    - Calibration 13
  - Gyroscope 13
- Service Plans 33
- Set up Tasks, Initial 4

- SIM Card 3, 21
- Software Included 47
- Speaker 2
- Specifications 44–51
- Storing the SHC6000 17, 26
- Stylus 3, 6
  - Stylus Storage Slot 2
  - Tether 6
- System Information 34

## T

- Task Manager 17
- Temperature Specifications 46
- Touchscreen 8–10
  - Calibration Tool 9
  - Protecting the Touchscreen 26
  - Settings 8
  - Specifications 45

## W

- Wall Charger 5, 16, 37
- Warnings 36–37
  - Battery Warnings 36–37
  - Wall Charger Warnings 37
- Warranty 30–33
  - Exclusions 30
  - Limitation of Liability 32
  - Remedy 31
  - Repairs 32
  - Services 33
  - Warranty Exclusions 30
- Wi-Fi Wireless Communication 14
  - Connecting to a Wi-Fi Network 14

# SOKKIA

[www.sokkia.com](http://www.sokkia.com)

Sokkia Corporation • 16900 W 118th Terrace • Olathe, KS 66061 • +1-800-4-SOKKIA  
Topcon Europe Positioning B.V. Essebaan 11 2908 Lj Capelle a/d IJssel The Netherlands •  
+31 (0)10-751 9300

©2022 Topcon Corporation • 7400 National Drive • Livermore, CA • 94550 • All rights reserved.  
Specifications subject to change without notice • 1034928-01 Rev C • 9/2022