

*SLX Receivers*  
*SLXg, WAAS, SLX-300*

Technical Manual  
Part No. 1050027-001H  
April. 30, 2000

© 2000 SATLOC (1999) INC. All Rights Reserved

**SATLOC**  
**PRECISION GPS APPLICATIONS**





## NOTICE TO CUSTOMERS

**SATLOC** is continually improving its products. Software is being upgraded to meet customer requests and improve operations.

This publication could contain technical inaccuracies or typographical errors. Changes are periodically made to the information herein; these changes will be incorporated in new editions of this publication.

**Technical Assistance.** Contact your local dealer for technical assistance. To find the authorized dealer near you call or write SATLOC at;

SATLOC, INC.  
Request for Dealer List  
15990 N. Greenway Hayden Loop  
Suite 800  
Scottsdale, AZ 85260

Phone: (480) 348-9919  
Fax: (480) 348-6370  
E-mail: [info@satloc.com](mailto:info@satloc.com)

Or look on our website at;

<http://www.satloc.com/dealers.stm>



**DEALER INFORMATION**

**NAME** \_\_\_\_\_

**ADDRESS** \_\_\_\_\_

**CITY** \_\_\_\_\_

**STATE** \_\_\_\_\_

**ZIP CODE** \_\_\_\_\_

**COUNTRY** \_\_\_\_\_

**PHONE** \_\_\_\_\_

**FAX** \_\_\_\_\_

**EMAIL** \_\_\_\_\_

**INTERNET** \_\_\_\_\_

**NOTES** \_\_\_\_\_

\_\_\_\_\_

\_\_\_\_\_

---

# TABLE OF CONTENTS

<b>NOTICE TO CUSTOMERS</b> .....	<b>3</b>
<b>TABLE OF CONTENTS</b> .....	<b>5</b>
<b>The SLX Receivers</b> .....	<b>11</b>
SLXg.....	11
SLXg with WAAS .....	11
SLX-300 .....	11
SLX-300 with WAAS .....	11
<b>SLXg</b> .....	<b>12</b>
<b>SLXg with WAAS</b> .....	<b>13</b>
<b>SLX-300</b> .....	<b>14</b>
<b>SLX-300 with WAAS</b> .....	<b>15</b>
<b>ABOUT THIS MANUAL</b> .....	<b>16</b>
Users Guide .....	16
Troubleshooting .....	16
Programming.....	16

<b>Users Guide</b> .....	<b>17</b>
<b>1.1 – INTERFACE</b> .....	<b>18</b>
Figure 1-1, SLX connectors .....	18
Pin out for SLX I/O connector .....	19
<b>1.2 – ANTENNA</b> .....	<b>19</b>
<b>1.3 – CABLES</b> .....	<b>20</b>
<b>1.4 – POWER</b> .....	<b>21</b>
<b>1.5 – COMMUNICATION</b> .....	<b>22</b>
<b>1.6 – INSTALLATION</b> .....	<b>23</b>
Installation Considerations.....	23
Electrical Grounding Requirements .....	23
Counter Electromagnetic Force (CEMF).....	24
Cable Installation Considerations .....	24
Antenna Location Considerations .....	25
SLX Mounting Instructions .....	26
Antenna Mounting Instructions.....	26
<b>1.7 – SETUP</b> .....	<b>28</b>
<b>1.8 – OPERATION</b> .....	<b>29</b>
GPS LOCK .....	29
DGPS LOCK .....	29

<b>1.9 – LED INDICATORS .....</b>	<b>30</b>
<b>1.10 – SETTINGS.....</b>	<b>33</b>
Baud Rates.....	33
Message Output .....	33
Diff Source.....	34
Mask Angle.....	34
Residual Limit (Green LED) .....	34
Altitude Aiding .....	35
Air Mode .....	35
Frequency and Bit Rate Selection.....	35
Diff Age Time-Out .....	36
<b>1.11 – DEFAULT CONFIGURATION .....</b>	<b>36</b>

## **Troubleshooting..... 37**

<b>2.1 – BASICS .....</b>	<b>38</b>
<b>2.2 – USING SLXG DIAG.....</b>	<b>39</b>
<b>2.3 – VIEW DIAGNOSTICS WITH SLXG DIAG .....</b>	<b>40</b>
RS232 .....	42
SLXg Receiver .....	42
Firmware .....	42
DGPS Being Used .....	42
Time .....	42
LEDs.....	43
DGPS Available .....	43
SPEED .....	43
Frequency .....	43
Current Setup.....	43
Position.....	44
ANT VOLTS / SN .....	44
DRIFT X DRIFT Y .....	44
Diff Frequency.....	44
LOCK.....	45
BER .....	45
DIF STATUS .....	45
DSP ARM.....	45
MARK.....	45
GPS DIF .....	46
EXPIRY .....	46
Countdown .....	46

---

DIF SATS, AGE, STDev .....	46
GPS WEEK, UTC/GPS difference .....	47
L-Band Subscription Beams.....	47
Satellites Tracking and Used .....	47
Satellite, Tracking Status, SNR.....	48
Messages .....	48
<b>2.4 – PRINTING THE DIAGNOSTICS .....</b>	<b>49</b>
<b>2.5 – BEACON DIAGNOSTICS .....</b>	<b>50</b>
Changing Differential Source .....	50
Beacon Station List .....	51
Frequency and Bit Rate Setup .....	51
Beacon Status Message .....	52
Beacon Signal Strength and SNR.....	52
<b>2.6 – CONFIGURE SLX PORTS WITH SLXG DIAG .....</b>	<b>53</b>
<b>2.7 – USING SLXMON .....</b>	<b>56</b>
Connecting to SLXMon .....	57
<b>2.8 – VIEW SLX DIAGNOSTICS WITH SLXMON.....</b>	<b>58</b>
<b>2.9 – SEND COMMANDS TO THE SLX RECEIVER WITH SLXMON .....</b>	<b>63</b>
<b>2.10 – VIEW NMEA AND RTCM MESSAGES WITH SLXMON .....</b>	<b>64</b>
<b>2.11 – LED FLOWCHART .....</b>	<b>65</b>
<b>2.12 – DIAGNOSTICS FLOWCHART .....</b>	<b>65</b>
<b>2.13 – CONCLUSION.....</b>	<b>67</b>

<b>Programming.....</b>	<b>68</b>
<b>3.1 – ABOUT SLX MESSAGES .....</b>	<b>69</b>
Sending Message Commands .....	69
<b>3.2 – NMEA MESSAGES.....</b>	<b>71</b>
GGA – Global Positioning System Fix Data.....	72
GLL – Geographic Position – Latitude/Longitude .....	72
VTG – Course and Ground Speed.....	72
GSV – GNSS Satellites in View .....	73
RMC – Recommended Minimum Specific GNSS Data .....	73
GSA – GNSS DOP and Active Satellites .....	74
ZDA – Time & Date .....	74
GST – GNSS Pseudorange Error Statistics.....	75
<b>3.3 – RTCM MESSAGES .....</b>	<b>76</b>
<b>3.4 – BIN MESSAGES .....</b>	<b>77</b>

Message Structure .....	77
<b>3.5 – DIAG MESSAGES .....</b>	<b>89</b>
<b>3.6 – CRMSS MESSAGES .....</b>	<b>92</b>
<b>3.7 – ABOUT SLX COMMANDS .....</b>	<b>93</b>
<b>3.8 – ERROR MESSAGES .....</b>	<b>94</b>
<b>3.9 – IMPORTANT POINTS .....</b>	<b>94</b>
<b>3.10 – LIST OF COMMANDS .....</b>	<b>95</b>
<b>3.11 – MESSAGE COMMANDS .....</b>	<b>96</b>
\$J4STRING .....	97
\$JASC,BEAC .....	98
\$JASC,D1.....	99
\$JASC,GPxxx.....	100
\$JASC,RTCM.....	101
\$JASC,VIRTUAL.....	102
\$JASC,X.....	103
\$JBIN.....	104
\$JOFF .....	105
<b>3.12 - CONFIGURATION COMMANDS .....</b>	<b>106</b>
\$GPMSK .....	107
\$JAGE .....	108
\$JAIR.....	109
\$JALT .....	110
\$JAPP .....	111
\$JBAUD.....	112
\$JCONN .....	113
\$JDCO.....	114
\$JDIFF.....	115
\$JFREQ.....	116
\$JK .....	117
\$JLIMIT .....	118
\$JMASK .....	119
\$JPOS.....	120
<b>3.13 – RESET and SAVE COMMANDS.....</b>	<b>121</b>
\$JRESET.....	122
\$JSAVE .....	123
<b>3.14 – SHOW COMMANDS.....</b>	<b>124</b>
\$JGEO.....	125
\$JI.....	126
\$JLBEAM .....	127
\$JLXBEAM.....	128



\$JOMR .....	129
\$JOMS .....	130
\$JSHOW .....	131
\$JSHOW,CONF .....	132
\$JSHOW,GP .....	133
\$JT .....	134
\$PCSI,1 .....	135

## **Frequently Asked Questions..... 136**

### **GENERAL ..... 136**

Q. How do I get L-Band service? .....	136
Q. Where is 300 kHz beacon signal available? .....	136
Q. What is WAAS, how do I get it and when can I start using it?.....	137
Q. Can my SLX-300 receiver be upgraded to receive WAAS Differential? .....	137
Q. I have an SLXg receiver, can I receive 300 kHz Beacon signal? .....	137
Q. Do the SLXg, SLXg with WAAS and SLX-300 receivers use the same antenna?.....	137
Q. Can I use my receiver in Europe?.....	138
Q. Can I purchase additional cables from SATLOC? .....	138
Q. Who do I contact for Service? .....	138

### **COMMUNICATION ..... 138**

Q. My receiver does not seem to be communicating. What do I do? .....	138
Q. What if I can't communicate with the receiver?.....	139
Q. Can the SLX receivers output through two different ports at different baud rates? .....	139
Q. How can I find out how my ports are set up? .....	139
Q. Do I need 10 Hz output? .....	140

### **GPS ..... 140**

Q. How do I know if my receiver has GPS?.....	140
Q. Can I lose GPS LOCK once I have it? .....	140

### **DIFFERENTIAL..... 140**

Q. How long does it take to get Diff? .....	140
Q. How do I know if my receiver has Diff? .....	140
Q. What is the accuracy of my receiver? .....	141

### **LEDs..... 141**

---

Q. No LEDs light up, what is the problem? .....	141
Q. Only one of the Yellow LEDs lights up, what does this mean? .....	141
Q. The Green LED doesn't light up, what can I do? .....	141
<b>INSTALLATION .....</b>	<b>142</b>
Q. Does it matter where the DGPS antenna is mounted? .....	142
Q. Can I connect my receiver to an isolated battery? .....	142

---

# The SLX Receivers

The SLX has grown to include four receiver options:

## **SLXg**

SATLOC 12-channel GPS receiver

SATLOC L-Band receiver for OmniSTAR signal

## **SLXg with WAAS**

SATLOC 12-channel GPS receiver

SATLOC L-Band receiver for WAAS signal

## **SLX-300**

SATLOC 12-channel GPS receiver

SATLOC L-Band receiver for OmniSTAR signal

300 kHz radiobeacon receiver

## **SLX-300 with WAAS**

SATLOC 12-channel GPS receiver

SATLOC L-Band receiver for WAAS signal

300 kHz radiobeacon receiver

---

# SLXg

The SLXg receiver is designed for multiple applications including air, ground, marine and GIS. It features:

- ◆ High Performance 12-channel GPS receiver
- ◆ Proven L-Band differential receiver for use with OmniSTAR network subscription
- ◆ Provides differentially corrected positions at up to a 5 Hz rate (5 times a second)
- ◆ 2 data ports with transmit and receive capabilities (RS-232)
- ◆ Position accuracy typically less than one meter
- ◆ Four LED indicator lights show operational status
- ◆ One-pulse-per-second output signal synchronized to GPS time
- ◆ Accepts manual-mark input for accurate event recording
- ◆ Outputs position information in NMEA or SATLOC Binary formats
- ◆ Outputs RTCM and diagnostic messages
- ◆ Accepts RTCM input from other DGPS sources
- ◆ Two diagnostic and configuration programs included
- ◆ Rugged waterproof construction
- ◆ Use any power source between 9.5 and 40 Volts DC
- ◆ Cables included
- ◆ One antenna for GPS/L-Band included

---

## SLXg with WAAS

Any SLXg receiver can be reprogrammed to use the WAAS system currently set to be fully operational by 2001. WAAS will be available everywhere in the U.S. including Alaska, Hawaii and Puerto Rico. A WAAS enabled SLXg has the following features:

- ◆ The same set of features as the SLXg, **PLUS...**
- ◆ Free L-Band differential
- ◆ Dependable signal maintained by the FAA
- ◆ Ongoing system enhancements for better positions
- ◆ Acceptance in the Aviation industry
- ◆ Uses same antenna as original SLXg

WAAS enabled receivers will not operate with the OmniSTAR L-Band service.

---

## SLX-300

Add the ability to receive 300 kHz radiobeacon signals to our L-Band receiver with the SLX-300. It features:

- ◆ The same set of features as the SLXg, **PLUS...**
- ◆ 2 channel 300 kHz beacon receiver
- ◆ Automatic beacon search or manual select
- ◆ Compatible with worldwide network of DGPS radiobeacons
- ◆ Select between L-Band or beacon receiver with ease
- ◆ One antenna for GPS/L-Band/300 kHz included

---

## SLX-300 with WAAS

The SLX-300 can also be programmed to accept WAAS Differential. This type of receiver will be capable of receiving GPS, 300 kHz Beacon and WAAS Differential. The WAAS system is currently set to be fully operational by 2001. WAAS will be available everywhere in the U.S. including Alaska, Hawaii and Puerto Rico. A WAAS enabled SLX-300 has the following features:

- ◆ The same set of features as the SLX-300, **PLUS...**
- ◆ Free L-Band differential
- ◆ Dependable signal maintained by the FAA
- ◆ Ongoing system enhancements for better positions
- ◆ Acceptance in the Aviation industry
- ◆ Uses same antenna as original SLX-300

WAAS enabled receivers will not operate with the OmniSTAR L-Band service.

---

# ABOUT THIS MANUAL

This manual is a complete guide to all aspects of the SLX receivers. It is divided into three sections for easy reference. You will also find a list of Frequently Asked Questions at the very end of the manual. If you have a problem, you may want to go there first, as each answer references pages in the text where you can find additional information.

## **Users Guide**

This will explain how to use the SLX receiver. Details about the SLX interface, installation and operation are given here.

## **Troubleshooting**

A comprehensive troubleshooting guide for the novice user. Also contains instructions to operate two utility programs for the SLX (*SLXMon* and *SLXg DIAG*).

## **Programming**

The SLX receivers can be configured using ASCII commands to change settings or output data strings. This section explains how to do this. This section also explains what information can be found in each message type, and how to use the available commands.



---

# Users Guide

---

The SLX receiver is easy to setup and use. Operation requires just three things:

- ◆ Antenna cable connection between the receiver and the antenna
- ◆ Antenna location with a clear view to the sky
- ◆ Cable connecting the receiver to an external source of power of 9.5 to 40 V DC

*Note: Using an L-Band receiver requires that a subscription for L-Band signal be purchased from OmniSTAR.*

Some external device is required to communicate with the receiver. Use the SLX receiver with a SATLOC guidance system, a third-party system, a Personal Computer (PC) or some data-recording device, utilizing a communications program. Communication with the receiver requires just two things:

- ◆ Communication cable connecting the receiver and the external device
- ◆ Baud rate setting on the external device must match the baud rate of the receiver

---

## 1.1 – INTERFACE

The SLX receivers are alike in the fact that they each have one antenna connector (RF) and one I/O connector (port A, port B and power). While the SLX-300 looks different in appearance, it has the same connectors as the SLXg shown in Figure 1-1:

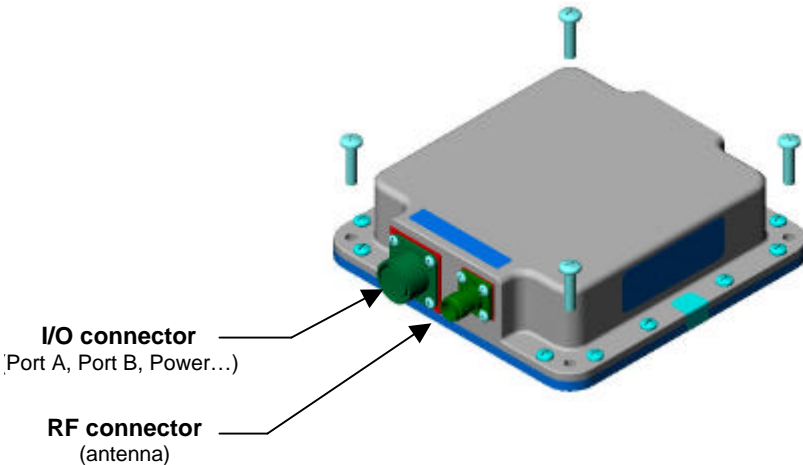

**Figure 1-1, SLX connectors**

The I/O connector is a standard metal eight pin circular Bendix style connector (PT02E-12-8P). This connector carries all the pulse, mark, data and power lines. This includes both Port A and Port B. The pin-out is defined in Table 1-1. Do not connect or disconnect this cable when the cable has live power.

The RF connector is a standard TNC 50 Ohm female connector to which you connect the included antenna cable. There are 5 Volts DC present when the unit is powered up to bias the LNA in the remote antenna. Do **NOT** connect or disconnect the antenna cable while the SLX is powered up.

## Pin out for SLX I/O connector

Pin	Name	Description
A	+ V in	9.5 to 40 V DC, 5 W, power input (12 V DC, 0.4 A)
B	1 PPS	One Pulse Per Second, 1 $\mu$ s width, rising edge aligned, TTL levels
C	Aux. Tx	Auxiliary communication port, transmit line, RS232 levels ( <b>Port A</b> )
D	Aux. Rx	Auxiliary communication port, receive line, RS232 levels ( <b>Port A</b> )
E	Diag. Tx	Primary communications port, transmit line, RS232 levels ( <b>Port B</b> )
F	Diag. Rx	Primary communications port, receive line, RS232 levels ( <b>Port B</b> )
G	Mark in	Manual Mark input line, TTL levels, falling edge triggered
H	Ground	Digital, power and analog ground

## 1.2 – ANTENNA



The SATLOC antenna (part no.1850060-002) is used with the SLXg and the SLXg WAAS receivers to receive both GPS and L-Band signal from the broadcasting satellites.



The SATLOC W3 antenna (part no.1850086-001) is used with the SLX-300 and the SLX-300 WAAS receivers and receives GPS, L-Band and 300 kHz beacon signal all at once.

Both antennas require 5 Volts DC in to power the antenna. The SLX receiver supplies this voltage to the antenna through the antenna cable. Because of the present voltage, Do **NOT** connect or disconnect the antenna while the system is powered up. This could damage the system.

---

## 1.3 – CABLES

Two cables are required to operate and communicate with the SLX receiver (an I/O cable and an antenna cable). Both of these cables are provided with the purchase of a new SLX receiver, but the exact cables included will vary depending on which system you bought.

When sold as part of a SATLOC guidance system, the SLX will likely be powered by the system through the I/O cable and be connected directly to the system CPU. See the system documentation for connection information. The antenna cable is generally the same type and length.

When sold by itself, the SLX receiver and antenna comes with the two cables shown in Figure 1-2. The I/O cable (part no.1500240-001) features power leads and two RS-232 serial connectors that are connected to port A and port B respectively. The round 8-pin Bendix connector connects to the SLX receiver.

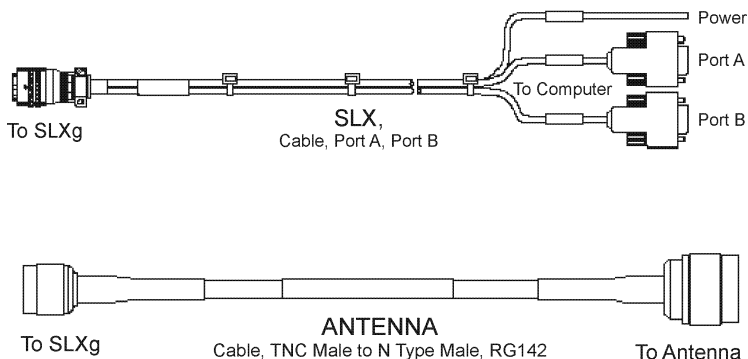

**Figure 1-2, SLX cables**

---

## 1.4 – POWER

The SLX receiver will operate on any DC Voltage between 9.5 and 40 V DC without interruption. When operational, the unit dissipates 5 W of power. Therefore, at 12 V DC, it will draw roughly 0.4 A and at 28 V it will draw roughly 0.2 A. At Voltages below 9.5 V DC, the unit will reset itself to prevent any data loss. At Voltages below 8.5 V DC, the receiver will turn itself off.

The SLX receiver can also withstand voltage surges up to 85 V. The input has reverse polarity protection, however, as the negative terminal (pin H) is also attached to the housing, large currents may flow to any ground attachments made to the housing. Reverse polarity must therefore be avoided to prevent damage to the vehicle supply.

---

## 1.5 – COMMUNICATION

The SLX communicates to an external device through either of its two ports (A and B). These two ports are sometimes called by these names:

- ◆ Port A – GPS Port – Auxiliary Port
- ◆ Port B – DIAG Port – Primary Port

The following data parameters are the same for each port and cannot be changed:

- ◆ Data bits 8
- ◆ Parity None
- ◆ Stop bits 1

The baud rate of each port is user configurable, however, and by default are set as follows:

- ◆ Port A – 4800 baud
- ◆ Port B – 19200 baud

Although the two ports are nearly identical, there are two major differences:

- ◆ The default settings are different
- ◆ Only Port B may be used to re-program the SLX receiver with new firmware

---

## 1.6 – INSTALLATION

Take a minute to read this section before attempting to install your receiver. While the process is simple, caution must be taken as to not damage the system. Please call your local dealer or service center if you have any questions regarding the installation of your SLX receiver. If you cannot contact one directly, call SATLOC Customer Service support.

### **Installation Considerations**

- ◆ Determine preferred location of each unit prior to beginning installation. Consider cable length, connector attachment space (cable bend radius), stowing excess cable, moisture, chemical corrosion, vibration and heat exposure.
- ◆ Before drilling holes, consider using existing hardware and hardware locations. Avoid drilling holes that may damage other equipment (example: structural frame members, electrical cables or fluid lines).
- ◆ High vibration and high temperature locations should be avoided whenever possible.
- ◆ In applications where vibration exceeds 5 G's acceleration, shock mounts are required. Refer to Customer Support for mounting recommendations.
- ◆ Vehicle primary power contains voltages that may be harmful to personnel and equipment. Detach battery cable connector from battery Negative (-) terminal before attempting connection to any power terminals.

### **Electrical Grounding Requirements**

The SLX requires a perfect ground to vehicle structure at the negative line in the receiver power input. The L-Band Receiver should read 0 Ohms to where the battery negative terminal is connected to vehicle ground.

---

## Counter Electromagnetic Force (CEMF)

A potential problem inherent in any installation of electronic systems in a vehicle is Counter Electromagnetic Force (CEMF). CEMF is caused when relays or solenoids connected to the common vehicle DC power bus are de-energized. The voltage produced may exceed -400 volts. CEMF is produced by equipment such as the following:

- ◆ Electric Fan Brakes
- ◆ Air Conditioners
- ◆ Starter Relays
- ◆ Electric Pump Relays

CEMF is more than sufficient to damage, or cause erratic operation of any electronic system also connected to DC power.

CEMF can be eliminated by installing Diodes at the relays and solenoids that cause the CEMF and more importantly, at the Power Supply Cable connection of the SLX system. A 47 V, 5 W, Zener Diode (1N5368 or equivalent) should be connected.



**Figure 1-3, Zener Diode**

## Cable Installation Considerations

- ◆ Cables must be correctly installed for optimum system operation.
- ◆ Do not route SLX Receiver antenna cable with those of any other radio system cabling, as this may cause interference between both systems. If at all possible, do not run SLX Receiver antenna cables



---

parallel to other radio system cables closer than 12 inches.

- ◆ If any cables must cross; cross them at a 90-degree angle. This prevents interference between systems.
- ◆ Cable and I/O connectors are unique and fit only in the correct place.
- ◆ Routing cables along side power generator wires and other high noise electrical source may cause interference.
- ◆ Do not kink or force cables into sharp bends that may damage cables and cause system failure. After installation, ensure that excess cable is looped and clamped or tied safely away from any control cables, fuel lines, hydraulic lines or moving parts. When stowing over length cables, form loop not less than 6-inch minimum bend radius.
- ◆ Cable routing must avoid high temperature exposure (example: exhaust manifold).

## **Antenna Location Considerations**

Antenna position is critical to system performance. These conditions must be met for proper system operation:

- ◆ SLX antenna must be mounted at least 5 feet away from transmitting antennas of any frequency. Closer positioning may cause overloading of receiver RF circuits.
- ◆ The SLX antenna should be mounted at the highest practical point that will give a good view of the horizon and be as near as possible.
- ◆ The SLX Receiver must be located along the vehicle centerline when using with a swath guidance system.
- ◆ Remember, the positions that the SLX receiver calculates are at the position of the antenna. Place antenna accordingly.

---

## SLX Mounting Instructions

The SLXg receivers are mounted to a vehicle or other surface with #10-32 bolts (4.83 mm) at the four mounting holes located in the corners of the receiver. Use #10 split ring washers and #10-32 nylon nuts for a secure mount. Use the receiver as a template to mark and drill, if necessary, four ¼" holes (6 mm) into the mounting surface.

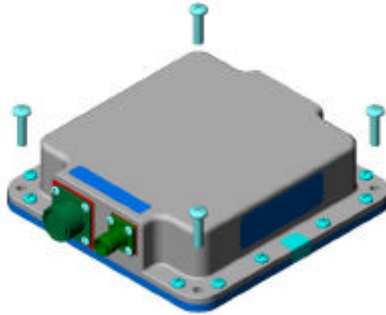

**Figure 1-4, SLXg Mount**

The SLX-300 receivers are mounted using #8-32 bolts into the four pre-installed #8-32 nuts in the side mount rails (two on each side) of the receiver. Because the mounting nuts can slide along the length of the receiver, you have some flexibility when choosing mounting locations. Mark and drill, if necessary, four 13/64" holes (5 mm) into the mounting surfaces. The length of bolt needed depends on the thickness of the surface it is being mounted to.

Position the receiver so that there is plenty of room to connect and disconnect cables and so that the four LED indicators are visible on the front of the receiver. Make sure it is mounted securely.

## Antenna Mounting Instructions

The SLX antenna comes with an antenna mounting kit, which includes both a magnetic mounting plate and a bolt down mounting plate. Depending on your

---

application and preference, you may choose either mounting option.

The antenna kit also includes a 3" extension (76 mm) post that makes installation easier and makes room for the antenna cable connection above the mounting surface. Use Figure 1-5 below to assemble the antenna kit.

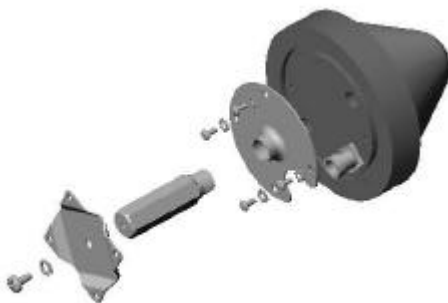

**Figure 1-5, Antenna Mount**

Mount the antenna to the mounting plate using four #8-32 bolts that are  $\frac{1}{4}$ " in length (6 mm) and four #8 star washers. Screw the extension post into the socket of the mounting plate. Use a  $\frac{1}{4}$ " bolt to attach either the magnetic or bolt down bottom plate to the bottom of the post. Use #8-32 bolts to attach the bolt down plate through drilled holes that are  $\frac{13}{64}$ " (5 mm) in diameter. Use star washers and nyloc nuts to secure installation.

---

## 1.7 – SETUP

Make sure all the following steps have been completed to assure proper operation of your SLX receiver:

- ◆ Connect the included SLX antenna to the SLX receiver with included antenna cable.
- ◆ Position the SLX antenna at the highest point of the vehicle or operating location so that it is pointing to the sky and no obstructions loom over it.  
*(Note: 300 kHz beacon signal is not a line-of-sight signal, thus the antenna does not need as clear a view of the sky as an L-Band antenna does)*
- ◆ Use included communications cable to attach the SLX to desired instrument or guidance system.
- ◆ Make sure attached instrument or system is set to communicate at the same baud rate as the SLX Port it is attached to.
- ◆ Attach the SLX system to an appropriate power source, minding the power guidelines found in the **POWER** section.
- ◆ If using an SLXg receiver, make sure that an L-Band subscription has been purchased and activated for the given receiver.
- ◆ If using the 300 kHz beacon receiver, make sure you are in an area where beacon signal is available.
- ◆ Power up the system and wait for the receiver to find at least 4 GPS satellites and to acquire a DGPS solution (may take up to 30 minutes for first use).
- ◆ Make sure that all these requirements remain implemented throughout use.

---

## 1.8 – OPERATION

Operation of an SLX receiver is relatively autonomous. The receiver will work out of the box, and for most applications, little user interaction with the receiver is necessary. SLX receivers are pre-configured to work correctly with a SATLOC guidance system or GIS package.

### **GPS LOCK**

When an SLX receiver is powered up it will begin searching for GPS satellite signals. It requires at least four satellites to calculate a 3D GPS position. This is considered GPS LOCK.

### **DGPS LOCK**

It should take the receiver less than 10 minutes\* to acquire Differential LOCK. This is when it calculates a correction to the GPS position from the information acquired from the DGPS source being used (L-Band, WAAS or 300 kHz). At this point the SLX receiver will report a DGPS calculated position accurate to within one meter. Accuracy gradually improves during the first few minutes of LOCK. The receivers can be set to search for a differential signal (L-Band or Beacon) automatically or to look for a specific preset signal.

SATLOC guidance systems have various ways to alert the user that the receiver has DGPS LOCK. Reference the system documentation for this information. If you are not using a SATLOC guidance system, you can view the SLX receiver LED indicators to check if the receiver has LOCK.

\* LOCK can take up to 30 minutes when a receiver is being turned on in a new region. Subsequent power ups should only take the receiver a few minutes to achieve LOCK.

---

## 1.9 – LED INDICATORS

The SLX receiver has 4 LED indicator lights that serve as status indicators. These lights should all be illuminated solid (non-blinking) when the receiver is powered on and has a valid GPS and differential solution.

Otherwise, the lights can be in various states (blinking, on solid, or off). Table 1-2 describes the LED light operation. The behaviors listed in this table are the same for each type of SLX receiver except where specifically noted.

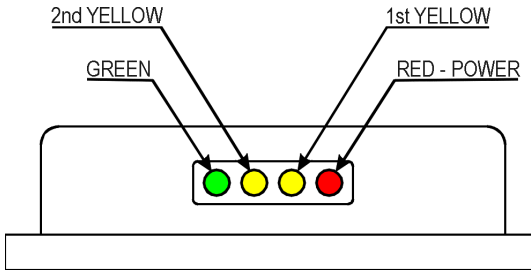

**Figure 1-6, SLXg LEDs**

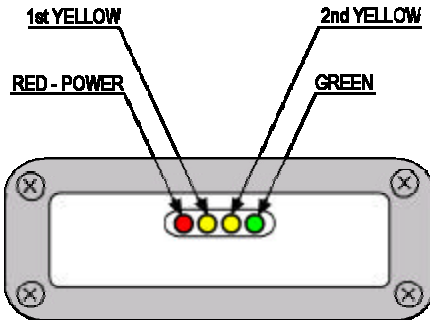
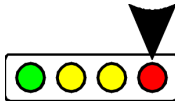

**Figure 1-7, SLX-300 LEDs**

Note: The SLX-300 LEDs work the same way as the SLXg LEDs, but they are in a reverse order because their orientation inside the receiver is opposite.

## LED Functions, SLXg, SLXg WAAS and SLX-300

Table 1-2



(Shown as seen in an SLXg. SLX-300 is reversed)

### Red LED:

This LED should be on solid once power is applied to the receiver. This is the only LED that is not under computer control.

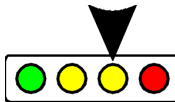

### 1<sup>st</sup> Yellow LED: (LED closest to Red)

This LED serves two purposes:

- At power-on it will blink 3 to 4 times, once per second, and then go off. If it fails to blink, the Differential processor is likely to have failed. If it does not stop blinking, the GPS processor is the likely culprit.
- After a minute or so, this LED should go on solid yellow to indicate that GPS has lock. This is true even if differential corrections are not available.

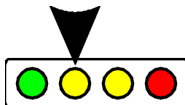

### 2<sup>nd</sup> Yellow LED: (LED closest to Green)

This LED can be in several states:

- Off – Differential signal has not been received.
- Flickering on and off – the receiver is close to acquiring the differential signal. – L-Band only
- Blinking at a steady rate – L-Band and WAAS only
  - L-Band** – Differential signal has been acquired, but the Bit-Error-Rate (BER) is higher than 150.
  - WAAS** – Differential signal has been acquired, but the BER of the “best” signal tracked is higher than 150.Generally, this will not affect performance, but it is a warning of weak signal strength.
- On Solid – L-Band or WAAS signal has been acquired and signal strength is good. Or Beacon receiver recognizes RTCM output.

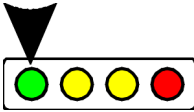
**Green LED:**

This LED will remain off until a differentially corrected GPS solution is available. It will blink at a steady rate if the solution has not converged to the accuracy specified by the \$JLIMIT command and will become solid green after the solution has converged. (The \$JLIMIT sets the threshold for the RMS residual error and this error gives a rough indication of expected user accuracy. Note, however, that it is not a direct measure of accuracy. Factors such as constellation geometry must also be taken into account. The default value for \$JLIMIT is 10 meters)

**Other Conditions:**

If at startup, the two yellow and one green LED blink in sequence 3 times, then the subscription on the receiver has expired.



---

## 1.10 – SETTINGS

SLX receiver settings can be configured with an external computer connected to one of the SLX data ports. The basic settings that a user can define for their specific application are:

- Baud Rates
- Message Output
- Diff Source
- Mask Angle
- Residual Limit (Green LED)
- Altitude Aiding
- Air Mode
- Frequency and Bit Rate Selection
- Diff Age Time-Out

Settings can be changed using the SATLOC **SLXMon** program for Windows or a Terminal communications program. These programs allow ASCII commands, necessary to change settings, to be sent to the receiver. See Section 2.8 for instructions on how to use SLXMon to issue commands to the SLX receivers.

### **Baud Rates**

The user can set the baud rates of ports A and B independently. The available baud rates are 4800, 9600 and 19200 baud.

### **Message Output**

There are several different message types the user can request from the SLX. Each message type contains its own set of specific information. The user can turn on and off each message as well as setting the output rate and destination port. Information one could gather from the messages includes, but is not limited to, position, altitude, course, speed, date, time, satellite info, DGPS info, and subscription info. There are both ASCII and

---

binary message types. See sections 3.2 thru 3.6 for a complete description of each message type.

### **Diff Source**

With the new line of SLX receivers, the user now has the option of choosing their differential source. The options are Beacon, L-Band or some external differential source. If the user wishes to use some other external differential source, RTCM messages need to be sent to the SLX receiver through one of its data ports. WAAS receivers work by choosing L-Band. You must have an SLX-300 to choose Beacon.

### **Mask Angle**

The mask angle is often a difficult value to set. By setting a mask angle, you are setting the area of the sky that the receiver can search to find available GPS satellites. By setting the mask angle to 5 degrees, the receiver will not use any satellites that were found less than 5 degrees above the horizon. The reason to exclude these "low" satellites is because the signals they send to the SLX receiver are more affected by the atmosphere and earthly obstructions, resulting in less accurate data. The only problem with excluding them, however, is that it takes away from the total number of satellites being used and the SLX needs at least 4 satellites to acquire GPS LOCK. SATLOC recommends a setting of 5 degrees but the user is free to experiment with other settings.

### **Residual Limit (Green LED)**

The residual threshold limit marks the value that the rms pseudo-range residual must be lower than for the Green LED indicator to become solid. This value is in meters and is set to 10.0 meters as default. This value can be thought of as a rough approximate of position accuracy.

---

## **Altitude Aiding**

Altitude aiding is an option that results in better accuracy from the receiver but can only be used when the user's altitude remains constant. Certain marine applications can use this option to their benefit but should discontinue its use if ocean swells are changing the system's altitude. It is not recommended that this option be enabled with land applications because it is very difficult to remain in an area with the same altitude. Altitude aiding works by correcting the differences in computed altitude readings to make for a more accurate measurement of latitude and longitude.

## **Air Mode**

The SLX receivers have a built in option that makes for better performance when used in high dynamic air applications. Using Air Mode helps in situations where the antenna is often turned from the sky such as in aerial spray applications. The SLX receivers are shipped with Air mode in an automatic mode where it only turns on above 30 m/s. User can enable or disable Air mode. Air mode is not recommended during normal operation because it usually results in slightly higher noise levels.

## **Frequency and Bit Rate Selection**

The SLX receivers are set, by default, to search for the available differential frequencies available and use the best one found. For an L-Band unit, this means using a spot beam table to automatically choose the correct frequency based on GPS position. The beacon receiver chooses the two best frequencies based on signal strength and keeps track of them with its two channels. If a stronger signal becomes available, the receiver will automatically switch frequencies. It is recommended that the user leave the frequency set to auto, but it is possible to set the receiver to a specific differential frequency. If you set it to a specific frequency, it will no longer change automatically and will have to be manually set again if you leave the current region. You are also able to set the symbol rate or bit rate (MSK) of

---

the receiver to match the signal you are trying to receive. This is chosen automatically if your receiver is in auto frequency mode.

### **Diff Age Time-Out**

Diff age is a reflection of differential latency. Differential latency is a term that refers to the time it takes for original data to be sent to the DGPS receiver, calculated and then output as a position. Typically this delay is 4-5 seconds and is not a problem. If this delay grows too large, accuracy is affected and DGPS LOCK can be lost. The diff age Time-Out value tells the receiver how long the latency can be before DGPS LOCK is considered lost. The default value for this is 60 seconds. When the diff age count drops back below the Time-Out value, DGPS LOCK will be restored.

## **1.11 – DEFAULT CONFIGURATION**

Your SLX receiver may be pre-configured for your application. If it isn't, it still has factory default configuration settings. The default configuration settings are:

- ◆ Port A – Baud rate 4800, 8-N-1, All messages off
- ◆ Port B – Baud rate 19200, 8-N-1, All messages off
- ◆ Diff Source – L-Band
- ◆ Mask Angle – 5 degrees
- ◆ Residual Limit – 10.0 meters
- ◆ Altitude Aiding – Off
- ◆ Air Mode – Auto
- ◆ Frequency Selection – Auto
- ◆ Diff Age Time-Out – 60 seconds

If you want to change any of these settings, see Sections 3.7 thru 3.14.

---

# Troubleshooting

---

SATLOC knows how expensive 'down-time' can be in any of our customers' businesses. That's why we have developed this troubleshooting section for the SLX receivers.

This section explains how to use the two SLX utility programs provided by SATLOC for the SLX receivers. These programs, named **SLXMon** and **SLXg DIAG**, allow the user to view diagnostic information that is helpful in determining the operating status of the receiver.

There are also two troubleshooting flow charts that can pinpoint what kind of problem, in particular, you are experiencing. Often times a perceived problem with the receiver can be easily corrected without sending it in for repair.

You should also check the list of Frequently Asked Questions at the end of this manual for troubleshooting solutions.

---

## 2.1 – BASICS

The SLX receiver works by finding 4 or more GPS satellites in the visible sky above the antenna and uses the information from those satellites to compute an approximate position (within **100 meters**). Since there is some error in the GPS data calculations, information from the L-Band satellite transmit corrections and the SLX uses that to improve its position to within 1 meter.

This section is not meant as a replacement to a certified Service Center, but it can be very useful to go through the flowcharts before calling a technician or sending back a unit that may not actually need to be replaced.

---

## 2.2 – USING SLXG DIAG

SLXg DIAG is available for free from SATLOC. This program allows the user to configure the SLX ports and to view diagnostic information from the SLXg and SLX-300 receivers. SLXg DIAG runs on any PC with Windows 95, 98, or NT 4.0+. Screen resolution of 800x600 or greater is recommended. You must connect one of the receiver's two ports to a COM port on your computer. If you don't have SLXg DIAG, you can download it from our website at <http://www.satloc.com/software.stm>.

Start SLXg DIAG by double-clicking the SLXg DIAG.exe icon shown here:



When you open the SLXg DIAG program, you have two choices:

- ◆ SETUP -- (Configure ports and Message Output)
- ◆ DIAG -- (View Receiver Diagnostics)

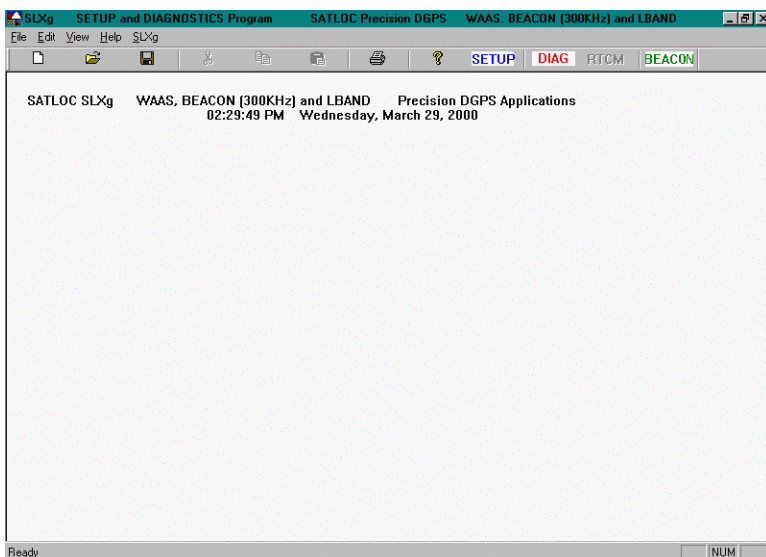

---

## 2.3 – VIEW DIAGNOSTICS WITH SLXG DIAG

Click on the **DIAG** button to view your receiver's diagnostic information:

**DIAG**

A window comes up that asks you to select the COM port of your computer that your receiver is connected to:



This would be either COM1 or COM2 on most personal computers. Be careful you do not accidentally choose the COM port your mouse is connected to, as this could freeze its use. Select the appropriate COM port and click **OK**.



The SLXg DIAG Diagnostics window will then open. If your SLX is connected to the computer and is powered up with the antenna in an open location to the sky with a valid subscription (if L-Band), the Diagnostics window should be populated with data:

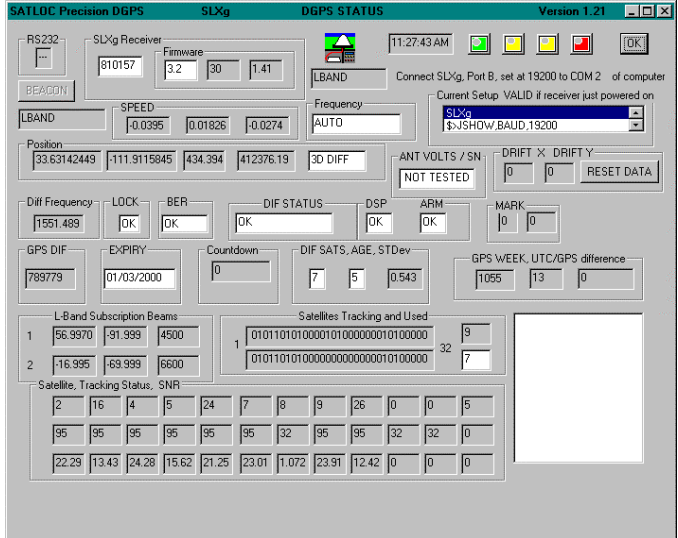

Try moving your mouse pointer over one of the data fields. The bubble that pops up explains the contents of that field:

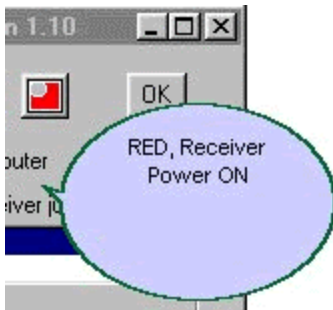

---

At first, very little of the information on this screen will be recognizable. But if you read the following descriptions, you will be able to tell from the information on this screen, just about everything there is to know about your receiver and how well it is working.

Lets look at the individual fields, from left to right:

## RS232



This little box is very important. It shows a little dashed line, and if the dashed line is spinning inside the box, then you know that the program is receiving data from the SLX receiver. This means that the receiver is communicating with the outside world.

## SLXg Receiver

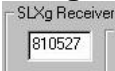

This field shows the connected receiver's serial number.

## Firmware



The first field shows the ARM firmware version. The second field shows the DSP firmware version. The third field is the OmniSTAR version number.

## DGPS Being Used



This field shows the type of differential currently being used (LBAND, BEACON, WAAS).

## Time

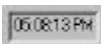

This shows your PC time.

---

## LEDs



These colored boxes work exactly the same as the LEDs on the front of the receiver. See Section 1.9 to see what they mean.

## DGPS Available



This field is different from the DGPS Being Used field. This field shows what possible DGPS sources there are with your receiver. An SLXg would show LBAND and the SLX-300 would show LBAND/BEACON. It does not specify which you are currently using.

## SPEED

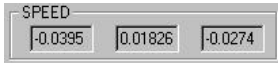

These three fields show the velocity in m/s in the x, y and z directions.

## Frequency

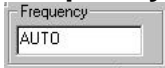

This field shows what frequency the receiver is set to use, or will show AUTO if the automatic frequency setting is selected.

## Current Setup

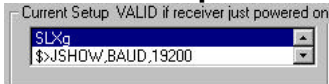

The scrolling field here shows the receiver's current setup. The information in this field can also be found by issuing the \$JSHOW command. See Section 3.14 for more information on this command.

---

## Position

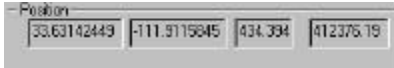

A screenshot of a 'Position' data display. It features a title bar with the text 'Position' and four input fields containing the following values: 33.63142443, -111.91159345, 434.394, and 412376.19.

The first two fields show current latitude and longitude values respectively. The third field is the current altitude in meters above the WGS-84 ellipsoid (not sea level). The fourth field shows GPS time in seconds.

## ANT VOLTS / SN

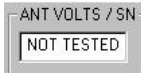

A screenshot of an 'ANT VOLTS / SN' data display. It features a title bar with the text 'ANT VOLTS / SN' and a single input field containing the text 'NOT TESTED'.

This field allows a test technician to enter a measured antenna voltage to appear on the printed report. This is not a feature that would be used outside of SATLOC.

## DRIFT X DRIFT Y



A screenshot of a 'DRIFT X DRIFT Y' data display. It features a title bar with the text 'DRIFT X DRIFT Y', two input fields containing the value '0', and a button labeled 'RESET DATA'.

These two fields show the position drift in meters in the x and y directions since last reset. These values can be reset to zero by clicking the RESET DATA button. This is a useful test if your receiver's antenna is stationary to tell how accurate the positions are and how much they vary over time. The RESET DATA button also clears the box of Messages at the bottom right corner of the screen.

## Diff Frequency



A screenshot of a 'Diff Frequency' data display. It features a title bar with the text 'Diff Frequency' and a single input field containing the value '1551.499'.

This field shows the differential frequency currently being used by the receiver. This does not show if it is in automatic mode or not.

---

## LOCK



This field reports if there is differential LOCK or not. It should say OK when you have LOCK. If it says NO, you have not yet achieved LOCK.

## BER



This field shows the current BER value (Bit Error Rate). The BER value is good when less than 20. It can reach as high as 500 when bad. If the BER is 0, this field will show OK.

## DIF STATUS



This field shows OK when differential is good.

## DSP ARM



These two fields show status codes for the DSP and ARM in the SLXg receiver. See Table 3-12 in Section 3.5 to decode these codes. This field will show OK if the status code is 1F meaning that there is DGPS LOCK.

## MARK



The first of these two fields will show 0 until the receiver detects a manual mark. If a manual mark is detected the first field will briefly display a 1 and then redisplay a 0. The second of these two fields is a manual mark counter and will increase by one whenever a manual mark is detected. This value is returned to 0 when the receiver is powered off.

---

## GPS DIF



This field shows the NAV condition codes that are explained in Table 3-13 in Section 3.5. The most important number is the second one (in this case a “7”), which shows how many satellites have differential. At least 4 satellites must have differential to achieve DGPS LOCK.

## EXPIRY



This field reports the valid subscription expiration date of an SLXg receiver using OmniSTAR signal.

## Countdown

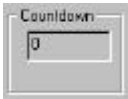

This field shows the remaining time of an OmniSTAR subscription that was purchased hourly. A normal subscription is not hourly, thus this will remain 0.

## DIF SATS, AGE, STDev



The first field is important, for it shows the number of valid satellites used for DGPS. This must be at least 4. The second field shows the Diff Age in seconds. This is a measure of differential latency and should stay between 4 and 8 for an L-Band and below 15 for a beacon receiver.

---

## GPS WEEK, UTC/GPS difference



A screenshot of a form titled "GPS WEEK, UTC/GPS difference". It contains three input fields: the first contains "1055", the second contains "13", and the third contains "0".

The first field here shows the GPS week. This is the number of weeks since GPS was introduced in 1980. This value is used to determine the date from GPS signal. The second field shows the difference between UTC and GPS time. A time gap of approximately 13 seconds has developed due to the gradual slowing of the Earth's rotation speed. UTC is the time typically used on Earth and matches the time used to determine time zones and such.

## L-Band Subscription Beams



A screenshot of a table titled "L-Band Subscription Beams". It has two rows and three columns. The first row contains values 1, 56.9970, -91.999, and 4500. The second row contains values 2, -16.995, -69.999, and 6600.

	Latitude	Longitude	Radius (km)
1	56.9970	-91.999	4500
2	-16.995	-69.999	6600

These fields define the area within which your OmniSTAR L-Band subscription is valid. The first two fields of each line show latitude and longitude to define a center point. The third field shows a radius that expands out from that center point in kilometers.

## Satellites Tracking and Used

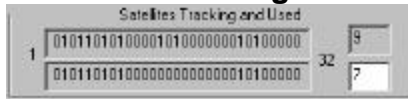

A screenshot of a form titled "Satellites Tracking and Used". It shows two rows of binary data. The first row is "0101101010000101000000010100000" with a tally of "9" to its right. The second row is "0101101010000000000000010100000" with a tally of "7" to its right. A "32" is positioned between the two rows, indicating the total number of satellites.

The long fields of ones and zeros show how many satellites out of 32 are being tracked (top row) and being used (bottom row). A 1 means that that satellite is either being tracked or used and a 0 means it is not. The fields on the right show a tally of the number tracked and used. It takes 4 satellites being used to achieve 3D GPS LOCK.

---

## Satellite, Tracking Status, SNR

Satellite, Tracking Status, SNR												
	21	3	22	23	6	26	29	9	0	0	0	254
AV	95	95	95	95	95	95	95	95	32	32	32	0
	13.1	17.39	8.553	13.17	17.99	16.30	15.27	11.37	5.481	0	0	0

There are a number of fields here. Each column (vertical) represents an individual satellite that is being tracked. The top field of each column is the satellites ID number. The middle field of each column shows a bit mask telling the tracking status of the satellite. This value should show 95 for any satellite with a valid phase lock. See the Status field of Table 3.11 in Section 3.4 to decode bit mask. The bottom field in each column is the satellite SNR (Signal-to-Noise Ratio). This is a value that represents signal strength and quality from that satellite. A good SNR value is between 12 and 25. The AV field on the bottom left shows the average SNR of the satellites.

## Messages



This large white message window displays all report and error messages encountered while the SLX receiver is operating. Typically a number of error messages are encountered while the receiver is attempting to lock on (such as there being <4 satellites). It is recommended that this window be cleared by clicking the **RESET DATA** button above this field. This field allows an overnight test in which any overnight errors are reported in this window in the morning.



## 2.4 – PRINTING THE DIAGNOSTICS

If you move the Diagnostics window a bit in any direction, by dragging it by the title bar, you will see that a report has been created in the white background of the window. This is a printable report that contains most of the information in the diagnostics window.

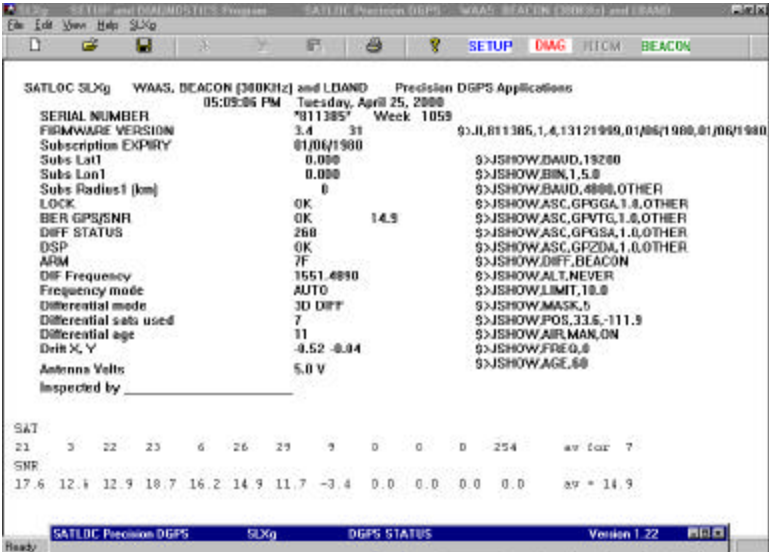

The screenshot shows the SATLOC Precision DGPS SLXg software interface. The window title is "SATLOC Precision DGPS SLXg" and the menu bar includes "File", "Edit", "View", "Help", and "SLXg". The main display area shows the following information:

SATLOC SLXg WAAS, BEACON (300KHz) and LDAND Precision DGPS Applications  
05:05:06 PM Tuesday, April 25, 2006  
"811385" Week 1059

SERIAL NUMBER	3.4	31	\$>JL,811385,1,4,13121999,01/06/1999,01/09/1999
FIRMWARE VERSION	01/06/1990		
Subscription EXPIRY	0.000		\$>JSHOW,DAUD,19200
Subs Lat1	0.000		\$>JSHOW,BIN,1,5.0
Subs Lon1	0		\$>JSHOW,DAUD,4000,OTHER
Subs Radius1 (km)	0K		\$>JSHOW,ASC,GFPGA,1,0,OTHER
LOCK	0K	14.5	\$>JSHOW,ASC,GFYTG,1,0,OTHER
BER GPS/SNR	260		\$>JSHOW,ASC,GFPGA,1,0,OTHER
DIFF STATUS	0K		\$>JSHOW,ASC,GFPGA,1,0,OTHER
DSP	7F		\$>JSHOW,DIFF,BEACON
ARM	1551.4890		\$>JSHOW,ALT,NEVER
Diff Frequency	AUTO		\$>JSHOW,LIMIT,10.0
Frequency mode	3D DIFF		\$>JSHOW,MASK,5
Differential mode	7		\$>JSHOW,POS,33.5,-111.9
Differential sats used	11		\$>JSHOW,AIR,MAN,ON
Differential age	-0.52 -0.04		\$>JSHOW,FREQ,0.0
Drift X, Y	5.0 V		\$>JSHOW,AGE,60
Antenna Volts			
Inspected by			

SAT  
21 3 22 23 6 26 29 9 0 0 0 254 av for 7  
SNR  
17.6 12.9 12.9 18.7 16.2 14.9 11.7 -3.4 0.0 0.0 0.0 0.0 av = 14.9

SATLOC Precision DGPS SLXg DGPS STATUS Version 1.22

Press the Printer button to print to your computer's default printer:



Note: Do not close the diagnostics window or the report will disappear. Just move it out off the screen a bit as shown.

## 2.5 – BEACON DIAGNOSTICS

If you are using the SLX-300 receiver, you can see beacon diagnostic information as well by clicking the **BEACON** button in the top left corner of the diagnostics window.

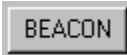

This button will be 'grayed out' if no beacon receiver is detected. The beacon diagnostics screen is shown below:

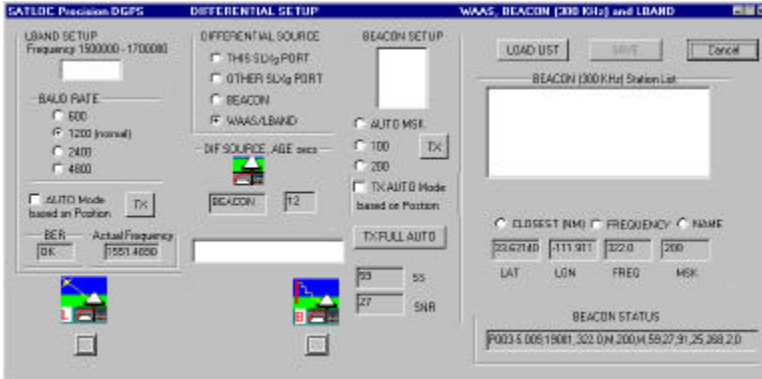

### Changing Differential Source

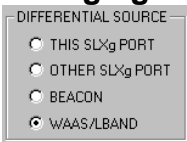

This selection allows the user to change the source of differential from within the SLXg DIAG program. The receiver will change diff source within a few seconds of clicking a new option. Watch the box directly under this

---

box to see what the currently used Differential source is and the current Diff age in seconds. This value will change when a new Differential source is chosen.



## Beacon Station List



SLXg DIAG includes a list of available beacon stations, their location and their transmitting frequency. Click the **LOAD LIST** button to load the list. The stations will load with the closest stations at the top of the list. You can also choose to sort the list by Frequency or Name. Then double-click a station to attempt to lock on to its signal.

## Frequency and Bit Rate Setup

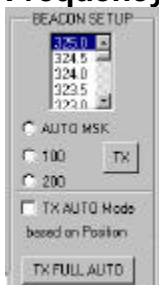

To manually set the Beacon Frequency, select the desired value from the scroll down list. To set the Bit

---

Rate (MSK), click on either AUTO MSK, 100 or 200. Then click the **TX** button to issue the command and have the changes take effect.

To set the beacon receiver to automatic frequency and MSK mode, click the **TX FULL AUTO** button.

## Beacon Status Message

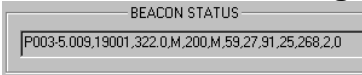

This field shows the status message reply to the \$PCSI,1 command. Inside this message you can see the Beacon receiver's frequency setting, MSK setting, SS and SNR, amongst other things. See Section 3.14 for more information on the \$PCSI,1 reply. This field will update a few seconds after you change the frequency or MSK settings.

## Beacon Signal Strength and SNR

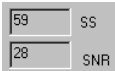

look at these fields to see the beacon Signal Strength (SS) and SNR values. The SS should be 20-60 and the SNR should be 15-30.

---

## 2.6 – CONFIGURE SLX PORTS WITH SLXG DIAG

Click on the **SETUP** button from the main SLXg DIAG window:

**SETUP**

A window comes up that asks you to select the COM port of your computer that your receiver is connected to:



This would be either COM1 or COM2 on most personal computers. Be careful you do not accidentally choose the COM port your mouse is connected to, as this could freeze its use. Select the appropriate COM port and click **OK**.

The Setup window then opens up. You will see that there are several choices listed for configuring your ports. Each choice (KIT) shows how it will configure Port A and how it will configure Port B.

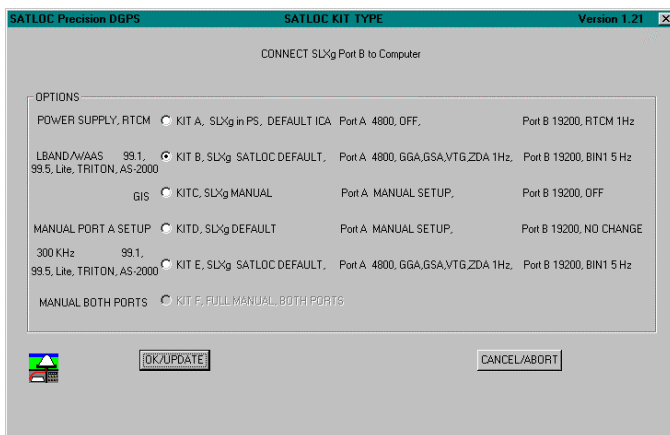

Make your choice by highlighting the appropriate radial button and then clicking **OK/UPDATE**.

If you selected a KIT that says MANUAL SETUP, a window will appear that allows the user to choose the baud rate and any of the eight NMEA strings for that Port. That window is shown below:



---

When the program is done configuring your ports, it will show the following screen:



Click **OK** and you are now free to disconnect the receiver and close the program. Its ports will be correctly configured as chosen.

---

## 2.7 – USING SLXMON

The SLXMon program is an in-depth diagnostic tool for the SLX receiver. It allows the user to:

- ◆ View Diagnostic information from the SLX receiver
- ◆ Send commands to the SLX receiver
- ◆ View NMEA and RTCM messages
- ◆ And more...

SLXMon is available for free from SATLOC. SLXMon runs on any PC with Windows 95, 98, or NT 4.0+. Screen resolution of 800x600 or greater is recommended. You must connect one of the receiver's two ports to a COM port on your computer. If you don't have SLXMon, you can download it from our website at <http://www.satloc.com/software.stm>.

Start SLXMon by double-clicking the SLXMon.exe icon shown here:



When you open the SLXMon program, it is best to maximize the program window to the full extent of the screen.



---

## Connecting to SLXMon



**Open Connection** – Click this button after you start the program. Make sure Port A or B from your SLX is connected to the serial port of your computer and that the receiver is powered on. Choose the communication parameters your computer should use to communicate with the SLX receiver from the pop up menu that comes up and then click **OK**:

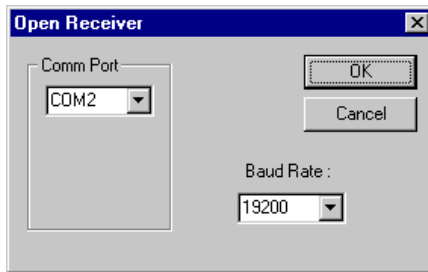

Now watch the status bar at the bottom of the SLXMon window:



If you are properly connected, the **Not Connected** message will be replaced with a Fix Status message and the current COM Port number and baud rate used will replace the **Not Open** message.

If the **Not Connected** message is never replaced, check that you are using the correct baud rate and that your connection to the computer's Com Port is not at fault. Also check that the SLX is receiving 9.5 – 40 VDC power.

## 2.8 – VIEW SLX DIAGNOSTICS WITH SLXMON

Once you have established communication, you will start to see data populate the open windows. The screen will look something like this:

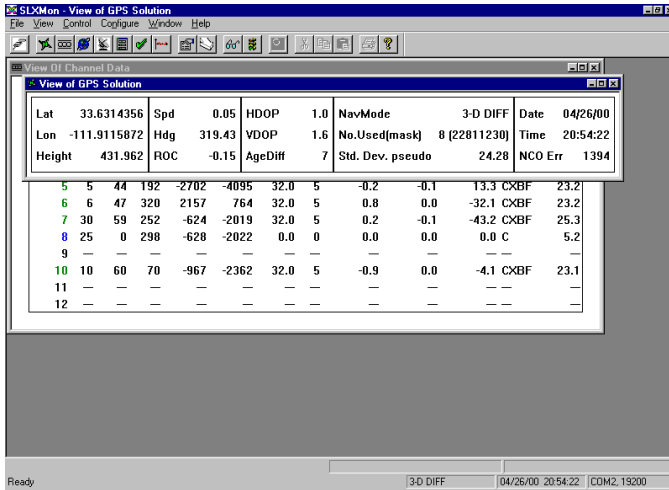

The buttons along the top of the window are used to open up windows in SLXMon. These windows are:



**View GPS Solution** – Click this button to view the GPS Solution window.

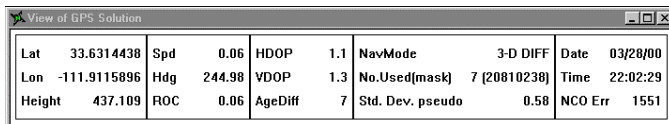

---

Check these fields:

**NavMode** – This field reports the Fix status and can show any of the following messages:

- ◆ No Fix
- ◆ 2-D NO DIFF
- ◆ 3-D NO DIFF
- ◆ 2-D DIFF
- ◆ 3-D DIFF

If you see any of these messages, except **No Fix**, then you are receiving GPS data. The SLX needs to find and use at least 4 satellites to receive 3-D position. Ideally, you should see **3-D DIFF**, which means you have 3-D GPS and a differential solution fix.

**No.Used[mask]** – This field reports the number of GPS satellites being used by the SLX to acquire a position (ignore mask value). This number must be 4 or greater to receive 3D GPS. If this number is less than 4 you should check for obstructions near the antenna. Check your antenna and antenna cable if this number is 0. A good value would be in the range from 5-12 satellites used.

**Note:** When your receiver is receiving GPS information from the satellites, the fields **Lat, Lon, Date** and **Time** will all report current information. If these fields remain at 0, then you likely have a GPS or antenna problem.

**AgeDiff** – This is the age of differential and should remain somewhere between 3 and 15 (the lower the better). If it says 0, then you do not have Differential. If it counts all the way up to 60, then you will lose your differential lock, and the green LED will go out.



**View Channel Data** – Press this button to view the Channel Data window.

CH	SV	ELV	AZI	Dopp	NCO	UERE	SF	PosRes	VelRes	DiffC	LOCK	SNR
1	13	4	94	1811	254	32.0	1	0.0	0.0	0.0	CXBF	10.7
2	17	12	240	2830	1280	32.0	1	1.1	0.0	-24.4	CXBF	14.8
3	24	50	34	-2015	-3567	32.0	1	0.9	0.0	-26.8	CXBF	23.6
4	4	12	52	-3072	-4628	32.0	1	-1.1	0.0	-22.0	CXBF	12.3
5	5	67	210	-1215	-2762	32.0	1	0.0	0.0	-17.6	CXBF	25.5
6	6	31	306	2388	838	32.0	1	-0.4	0.0	2.2	CXBF	18.3
7	25	0	316	748	-744	0.0	0	0.0	0.0	0.0	C	5.7
8	30	54	298	1334	-214	32.0	1	-0.1	-0.1	-17.2	CXBF	24.9
9	9	5	200	-2625	-4176	32.0	1	0.0	0.0	0.0	CXBF	8.9
10	10	58	124	1156	-394	32.0	1	-0.1	0.1	-34.2	CXBF	24.2
11	—	—	—	—	—	—	—	—	—	—	—	—
12	—	—	—	—	—	—	—	—	—	—	—	—

Each channel in this window represents a GPS satellite. The channel numbers are color coded to show whether or not a specific satellite is being used in the solution (Has Lock). There are as many satellites “In View” as there are channels with **SV** values in this window. The important fields in this window are:

**CH** – The Channel Number will turn Green when a satellite has full lock and is being used by the SLX to determine the position of your antenna. The number of channels with Green numbers is the same as the number of satellites used.

**ELV** – This is the Elevation of the satellite in degrees above the horizon. By default, the SLX will ignore any satellites lower than 5 degrees above the horizon. This can be changed by setting the Elevation Mask with the \$JMASK command as described later in this manual. The SLX is more precise when it has more than 4 satellites widely spread across the sky at various altitudes. This is called good geometry.

**LOCK** – Use this column when you cannot distinguish the colors of the Channel Numbers. When a satellite has lock, this value will be **CXBF**.

---

**SNR** – The Signal to Noise Ratio of a satellite is used to illustrate the relative quality of the information packets being received. A good SNR value is above 12.



**View SLX Monitor** – Press this button to view the SLX Monitor window.

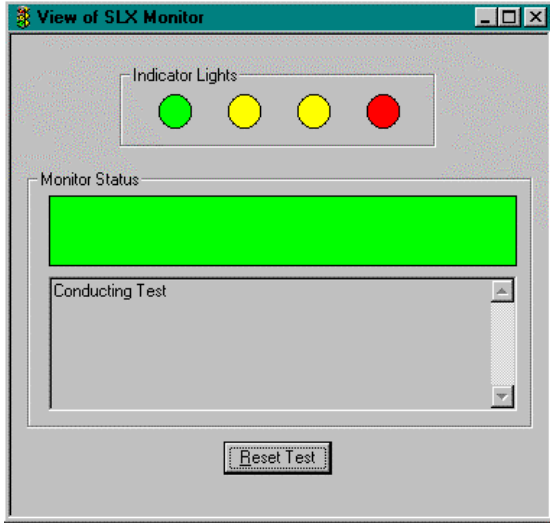

This window emulates the LED status lights on the SLX receiver. It also works as a test by reporting all errors the program detects while the SLX is running. Use this window as a quick reference to see if your SLX is operating correctly. If the colored rectangle labeled Monitor Status is green, then your SLX is operating correctly and has good accuracy. The Indicator Lights are the same as the SLX LED's. See Section 1.9 to find out more information about these LED's.



**View LBand** – Press this button to view the LBand Diagnostics window.

Bit Err Rate(BER)	0	DSP-ARM Status	1F-1F	Spot Beam Freq	1551.4890
L-Band AGC	39	DIFF Status	0	DDS Hz	-1536.0
L-Band UTC	03/28/00 22:05:00	Nav Condition	779999	Doppler From GPS	0

Check these fields:

**DSP-ARM Status** – This field displays two codes that will tell you whether the receiver has a valid DGPS solution. The code to look for here is **1F** for both the DSP and the ARM status. This means everything is good. Please see Table 13 in the DIAG message Section 3.5 later in this manual to see a breakdown on the meaning of the codes.

**Bit Err Rate(BER)** – Look to this field to determine the quality of the L-Band data received from the satellite. This number needs to stay below 100 to keep Differential lock. A good unit and antenna placement should show 0-20 BER.

## 2.9 – SEND COMMANDS TO THE SLX RECEIVER WITH SLXMON



**Command Window** – This window inside SLXMon allows the user to send any of the SLX commands and receive back its reply. A command list is shown with a brief description of each.

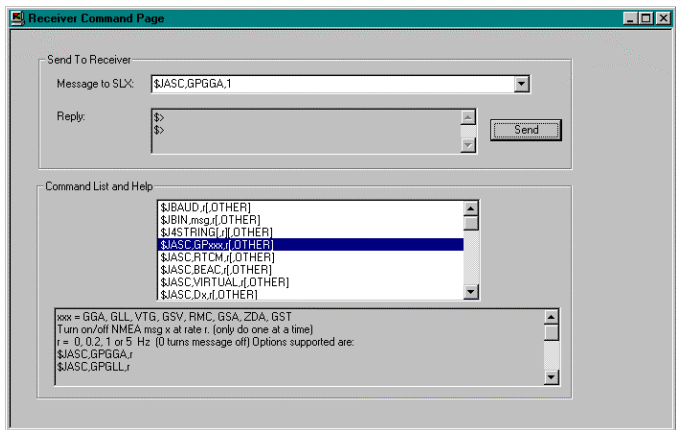

Some commands that can be used in Trouble shooting are:

- ◆ **\$JI** – Receiver Information, Expiration Date, Firmware, etc.
- ◆ **\$JLBEAM** – Current Frequency and spot beams.
- ◆ **\$JSHOW** – Port settings, messages and settings.
- ◆ **\$JSHOW,GP** – Current NMEA settings.
- ◆ **\$PCSI,1** – Beacon Diagnostics

See Sections 3.7 thru 3.14 to learn more about each command.

## 2.10 – VIEW NMEA AND RTCM MESSAGES WITH SLXMON



**View Text Messages** – Press this button to open the *Text Messages Window*. This window allows you to view *Replies*, *NMEA* messages and *RTCM* messages. This window only shows messages that are turned on for the port you are connected to. You must be at the correct baud rate to see messages correctly.

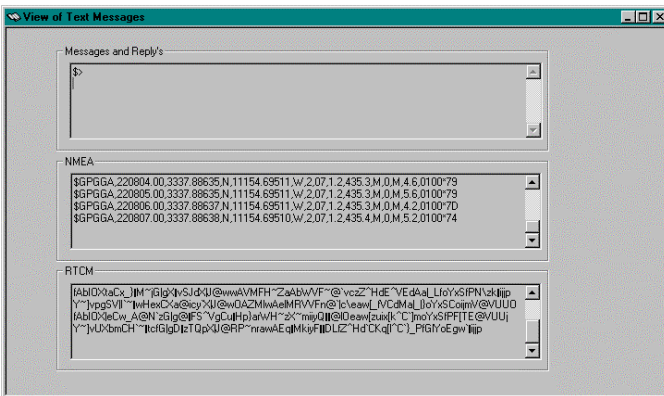

See Section 3.1 for information on how to turn on and off messages.



## 2.11 – LED FLOWCHART

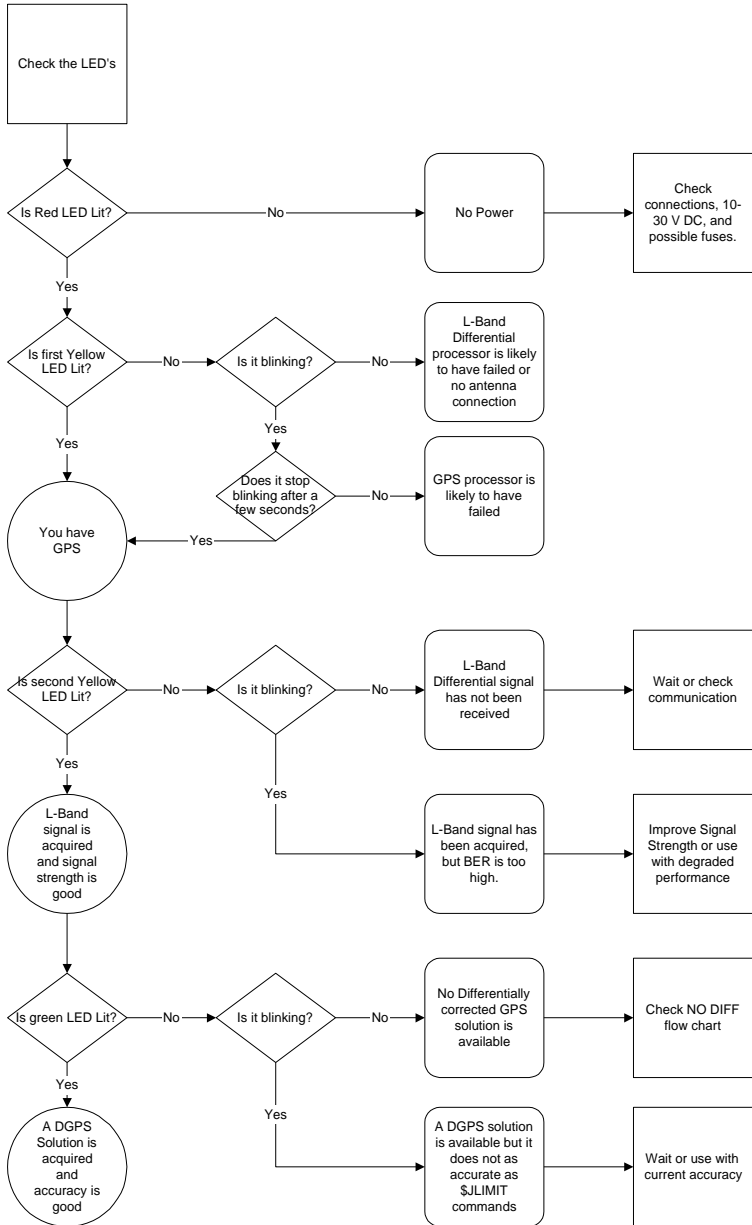

## 2.12 – DIAGNOSTICS FLOWCHART

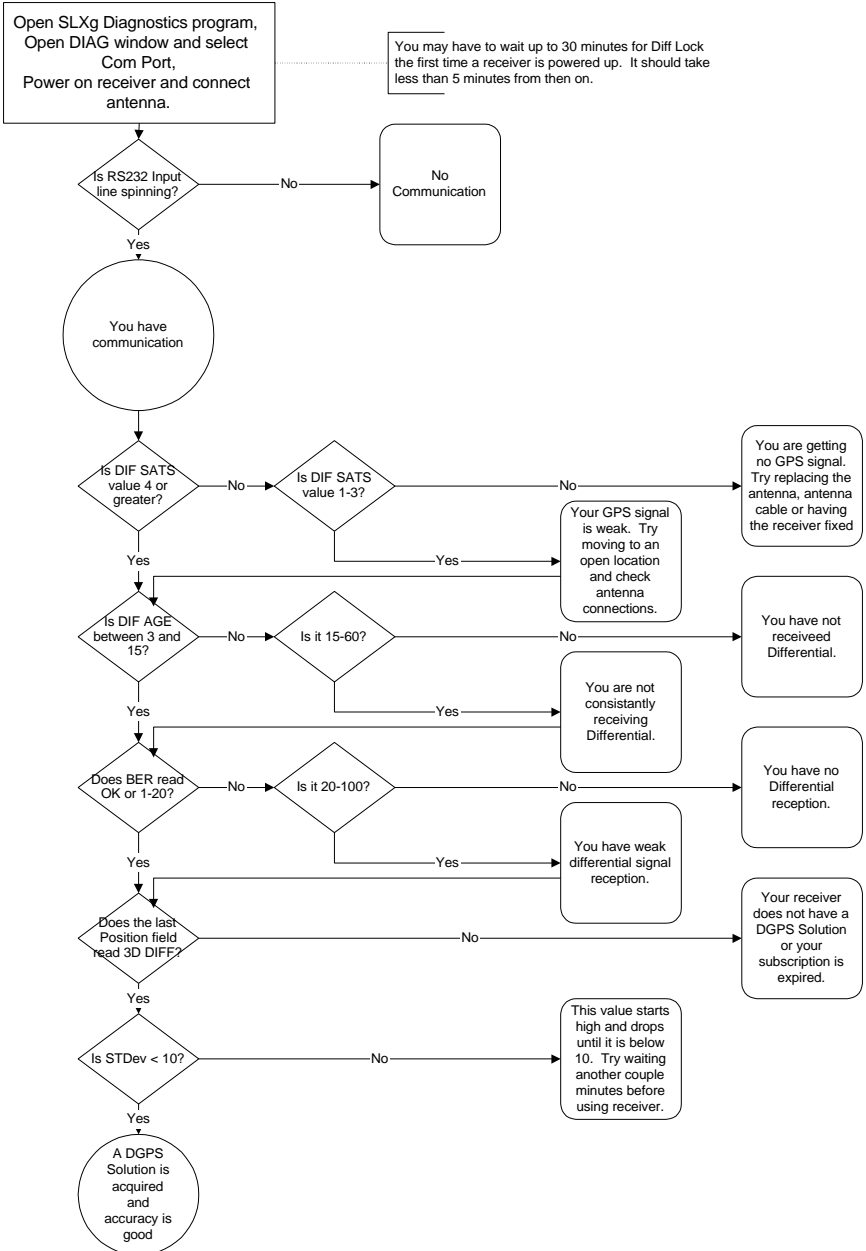

---

## 2.13 – CONCLUSION

You should now know the operation status of your SLX receiver. Most likely, everything is fine. Usually when a SLX does not seem to be operating properly, there are three things that the user should check for before calling for technical support.

- ◆ Is it properly powered up?
- ◆ Is the antenna connection good and does the antenna have a clear view of the sky?
- ◆ Are you communicating with the receiver through the correct Com Port at the right baud rate?

If these things seem to be all right, then consider the following potential problems:

- ◆ Have you set up the desired message output?
- ◆ Is some other equipment at fault?

Check the simple stuff and retrace your steps. Very often a silly mistake is to blame for time-consuming problems. If it becomes necessary to call for technical support, you can help to expedite the troubleshooting session by having the printout ready from the SLXg DIAG program or by writing down other key values found in this section.

---

# Programming

---

The user can control the output of data messages, view and change receiver settings and view system and (D)GPS information by issuing simple ASCII commands from either SLXMon or from any Terminal program.

This section will both detail the purpose and use of each ASCII command and will list, with details, the SLX supported message types.

## 3.1 – ABOUT SLX MESSAGES

The SLX outputs several forms of data strings called messages. This section will break down the meaning of each string type and describe the information fields in each. The available message types are NMEA, RTCM, BIN, DIAG and CRMSS.

### Sending Message Commands

Messages can be turned on or off of each port using ASCII commands. Use SLXMon or a terminal program to issue the commands that control the different message types. You must be communicating at the same baud rate as the receiver to issue commands and view messages.

SLX messages must start with a “\$” and end with a <CR><LF> (Carriage Return-Line Feed Pair). This can be achieved by pressing the **Enter Key** in Terminal or the **Send** button in SLXMon.



**Command Window** – This window inside SLXMon allows the user to send any of the SLX commands and receive back its reply. A command list is shown with a brief description of each.

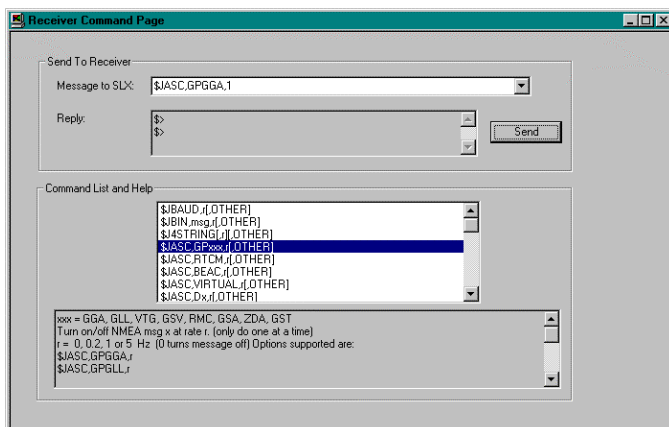

---

To choose a command, double click it in the *Command List*. You will see that it appears in the *Message to SLX* field above. Read the *Help* for the command you have chosen and replace the parameters in the command line with the values you desire. You can set either the port you are connected to or the OTHER port, by using or omitting the OTHER parameter. Click **Send** to send the command to the receiver. Any reply message will appear in the *Reply* box.

The commands that are used to control messages are:

- ◆ \$J4STRING – Turns 4 NMEA string messages on and all other messages off.
- ◆ \$JASC,BEAC – Turns on or off RTCM messages from beacon signal.
- ◆ \$JASC,D1 – Turns on or off DIAG message.
- ◆ \$JASC,GPxxx – Turns on or off NMEA messages.
- ◆ \$JASC,RTCM – Turns on or off RTCM messages from L-Band signal.
- ◆ \$JBIN – Turns on or off BIN messages.
- ◆ \$PSCI,1 – Turns on or off CRMSS message.
- ◆ \$JOFF – Turns off all messages except CRMSS.

See Section 3.10 for a complete list of commands and how to use their individual parameters.

---

## 3.2 – NMEA MESSAGES

The SLX receiver supports eight different NMEA 0183 string types. Some are restricted to certain output rates and some are more commonly used than others, but they all are controlled using the same ASCII command. NMEA strings are controlled with the \$JASC,GPxxx command. See Section 3.11 for more information on parameters of this command. The eight NMEA string types are: GGA, GLL, VTG, GSV, RMC, GSA, ZDA and GST.

The NMEA structure starts with a header, includes a number of data fields separated by the delimiter “,” and is finished with a checksum. The header is of the form \$GPxxx where xxx is the 3-letter string name (ex. GGA). The checksum is of the form \*XY where X is 0-9 and Y is A-F. See <http://www.nmea.org> for more information.

## GGA – Global Positioning System Fix Data

Time, position and fix related data. (0.2, 1 or 5 Hz)

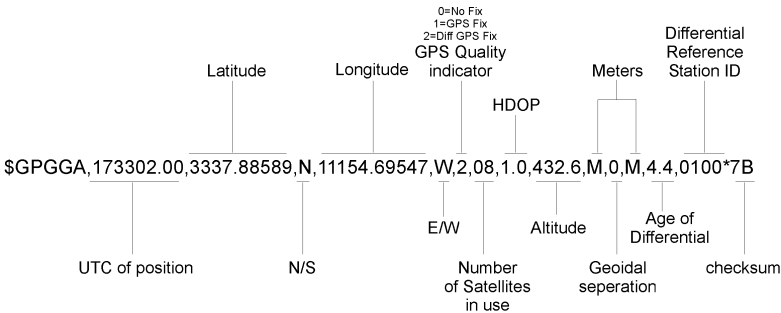

## GLL – Geographic Position – Latitude/Longitude

Latitude and Longitude of vessel position, time of position fix and status. (0.2, 1 or 5 Hz)

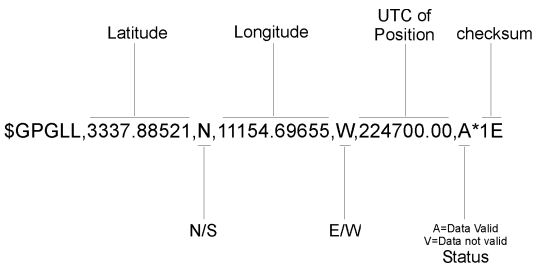

## VTG – Course and Ground Speed

The actual course and speed relative to the ground. (0.2, 1 or 5 Hz)

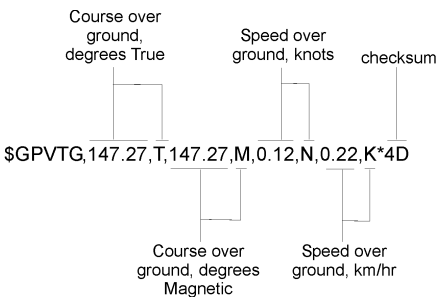



## GSV – GNSS Satellites in View

Number of satellites in view and ID, Elevation, Azimuth and SNR of each satellite. May contain up to 3 lines of data to show all satellites. (0.2 or 1 Hz)

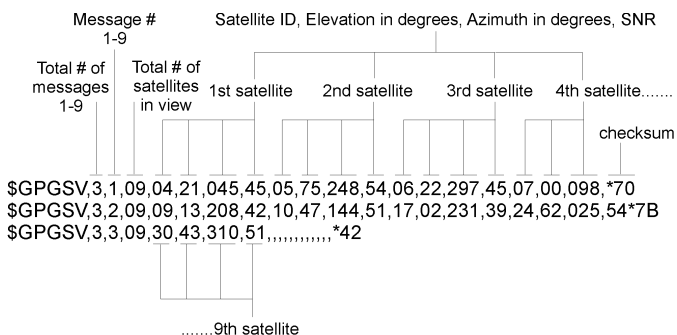

## RMC – Recommended Minimum Specific GNSS Data

Time, date, position, course and speed data. This message is transmitted at intervals not to exceed 2-seconds. (0.2, 1 or 5 Hz)

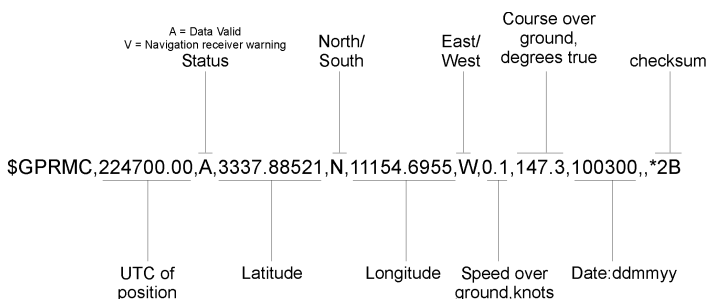

---

## GSA – GNSS DOP and Active Satellites

Receiver operating Mode, satellites used and DOP values. (0.2 or 1 Hz)

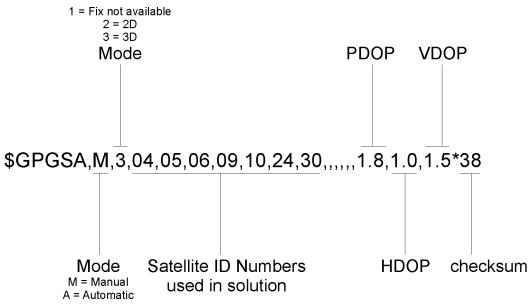

## ZDA – Time & Date

UTC, day, month, year and local time zone. (0.2, 1 or 5 Hz)

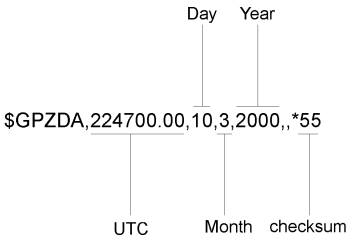

---

## GST – GNSS Pseudorange Error Statistics

Supports Receiver Autonomous Integrity Monitoring (RAIM). Can be used to determine the quality of the position solution. (1Hz only)

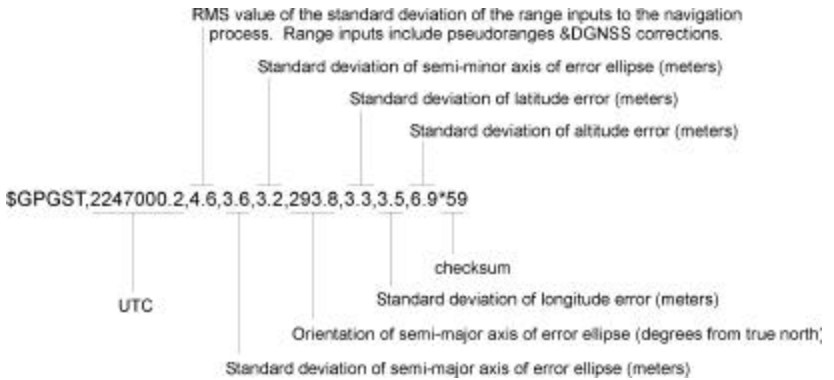

---

### 3.3 – RTCM MESSAGES

Differential information from the SLX can be found in the form of RTCM messages. Because these messages are in ASCII encoded binary form (6 of 8 encoding), you will need a program to decipher the data and return specific information. Send the \$JASC,RTCM command to turn on or off RTCM from L-Band differential or \$JASC,BEAC from beacon differential. When on, RTCM will be output in strings at approximately a 1 Hz tempo. Occasional pauses are expected. Here is an example of some RTCM messages:

```
fAbIOXE1CC@sBLj\JHc_[^kQwC~oppxYxYP|JngPcw[X_y^\Vaq{fpCuaYX}ApYXQCv_o_Lxd|ijj@
fAbIOXUbCY@sEXJ\JH_k^cH|APO[DiGDP|J^Yo_Hd|_pvii^NdYO|M^hgB~K|Um|IyP^u_BbVUUZ
fAbIjgrU|M@sODj\JHc_K~DVwC~opB[_xHP|J^Y`_Hdz`PM}IVaq{CO@L^OX}ABjWm|I\o_xoHbVUUZ
fAbIjgbY|L@KBZj\JHF`LBKxH|APjFXWx|oCuiR`_Hdz`pBSMVaq{CO@A^BX}ArqWo|IUoowWQbVUU
Y~|vpg|Q|sBtvzUcuw`l@UEwC~oUQd1GroCu^xO`w[|_wsHWVaq{f`paXX}AZRHRCvXoo)w`lijj@
fAbIOXS`CR@|KGCZ\JHe_SrVwC~oUNdcGzoCuVLX_HdW_W[Oni^NdY@C^~gB~ITpQCvjpPBH_bVUU
Y~|vpgtW|cBTspUcuw`\BAMwC~oUZV`GHP|Je]X_Hdr`XdLei^NDk_qajgB~AEpSCvcPPMtx|ijje
Y~|vUX{dCxBT~|Z\JH@`MMH|APj}kSxJP|JcJD_HdS_GY}DVaq{q_aIX}AQhwM|IgPPGXg|ijj@
fAbIOX{mCiBT|uEcuwa_Cy[wC~opsi^x|oCuTAd]HdD_{UEAVaq{qo|argB~Newl|IqPpHTy|ijje
Y~|vUXWbCP@}[DqEcuwa_Cs]QwC~opWk\xCP|Jodsaw[Q_kWapi^NDNp@0^X}Aibwm|IgPpA1@bVUUZ
```

**RTCM Input** – The SLX can also be configured to accept external sources of differential corrections in RTCM SC-104 Type 1 or Type 9 format. Use the \$JASC,VIRTUAL command to use an external source of RTCM. See listing of commands for more information.

## 3.4 – BIN MESSAGES

BIN messages are SATLOC proprietary data messages in binary form. The tables in this section are designed for programmers wishing to use this data. SATLOC guidance systems and software for precise DGPS positioning use this data. Use the \$JBIN command to control these messages. See Section 3.11 for more information on issuing this command.

### Message Structure

Binary messages are little endian format (Intel format) for direct read in a PC environment. Each binary message begins with an 8-byte header and ends with a carriage-return line-feed pair (0x0D, 0x0A). The first four characters of the header is the ASCII sequence \$BIN. The general message structure for binary message data is as follows:

### Binary Message Structure

Table 3-1				
Group	Components	Type	Bytes	Value
Header	Synchronization String	4 byte string	4	\$BIN
	BlockID – a number which tells the type of binary message	unsigned short	2	1, 2, 95, 96, 97, 98 or 99
	DataLength – the length of the binary message	unsigned short	2	52, 16, 128, 228, 28, 68 or 304
Data	Binary Data – varying fields of data with a total length of <i>DataLength</i> bytes	mixed fields	52, 16, 96, 128, 300, 28, 68 or 304	Varies – see message tables
Epilogue	Checksum – sum of all bytes of the data (all <i>DataLength</i> bytes). The sum is placed in a 2 byte integer.	unsigned short	2	Sum of data bytes
	CR – Carriage Return	byte	1	0D hex
	LF – Line Feed	byte	1	0A hex
The total length of the binary message packet is <i>DataLength</i> plus 12 (8 byte header, 2 byte checksum, and 2 bytes for CR, LF).				

## Type 1 Binary Message

**Table 3-2**

Table 3-2				
This message has a BlockID of 1 and is 52 bytes excluding the header and epilogue. It consists of GPS position and velocity data. It is the only binary message that can be output at a 5 Hz rate. This table describes the constituents of this message in order.				
Name	Description	Type	Bytes	Values
AgeOfDiff	Age of differential, seconds	byte	1	0 to 255
NumOfSats	Number of satellites used in the GPS solution	byte	1	0 to 12
GPSWeek	GPS week associated with this message	unsigned short	2	0 to 65536
GPSTimeOfWEEK	GPS tow (sec) associated with this message	double	8	0.0 to 604800.0
Latitude	Latitude in degrees north	double	8	-90.0 to 90.0
Longitude	Longitude in degrees east	double	8	-180.0 to 180.0
Height	Altitude above ellipsoid in meters	float	4	
VNorth	Velocity north in m/s	float	4	
VEast	Velocity east in m/s	float	4	
VUp	Velocity up in m/s	float	4	
StdDevResid	Standard deviation of residuals in meters	float	4	Positive
NavMode	Navigation Mode, 0=No Fix, 1=2D No Diff, 2=3D No Diff, 3=2D with Diff, 4=3D with Diff. If bit 7 is set (left-most bit), then this is a manual mark position	unsigned short	2	0, 1, 2, 3, 4, or bit 7
Spare	Not used at this time	unsigned short	2	Future use

## Type 2 Binary Message

**Table 3-3**

Table 3-3				
This message has a BlockID of 2 and is 16 bytes excluding the header and epilogue. This message contains various quantities that are related to the GPS solution. This table describes the constituents of this message in order.				
Name	Description	Type	Bytes	Values
MaskSatsTracked	A mask of satellites tracked by the GPS. Bit 0 corresponds to the GPS satellite with PRN 1.	unsigned long	4	Individual bits represent satellites
MaskSatsUsed	A mask of satellites used in the GPS solution. Bit 0 corresponds to the GPS satellite with PRN 1.	unsigned long	4	Individual bits represent satellites
GpsUtcDiff	Whole seconds between UTC and GPS time (GPS minus UTC).	unsigned short	2	Positive
HDOPTimes10	Horizontal Dilution of Precision scaled by 10 (0.1 units).	unsigned short	2	Positive
VDOPTimes10	Vertical Dilution of Precision scaled by 10 (0.1 units).	unsigned short	2	Positive
WAAS PRN bitmask	PRN and tracked or used status masks	unsigned short	2	See Below

### WAAS PRN bit mask

Bit 0	Mask of satellites tracked by first WAAS satellite
Bit 1	Mask of satellites tracked by second WAAS satellite
Bit 2	Mask of satellites used by first WAAS satellite
Bit 3	Mask of satellites used by second WAAS satellite
Bit 4	Unused
Bit 5-9	Value used to find PRN of first WAAS satellite (This value + 120 = PRN)
Bit 10-14	Value used to find PRN of second WAAS satellite (This value + 120 = PRN)
Bit 15	Unused

## Type 94 Binary Message

**Table 3-4**

This message has a BlockID of 94 and is 96 bytes excluding the header and epilogue. This message contains Iono and UTC conversion parameters. This table describes the constituents of this message in order.				
Name	Description	Type	Bytes	Values
a0,a1,a2,a3	AFCRL alpha parameters	double	8x4 = 32	
b0,b1,b2,b3	AFCRL beta parameters	double	8x4 = 32	
A0,A1	Coefficients for determining UTC time	double	8x2 = 16	
tot	Reference time for A0 and A1, second of GPS week	unsigned long	4	
wnt	Current UTC reference week	unsigned short	2	
wnlsf	Week number when dtlsf becomes effective	unsigned short	2	
dn	Day of week (1-7) when dtlsf becomes effective	unsigned short	2	
dtls	Cumulative past leap	short	2	
dtlsf	Scheduled future leap	short	2	
Spare	Not used at this time	unsigned short	2	Future use



---

## Type 95 Binary Message

**Table 3-5**

This message has a BlockID of 95 and is 128 bytes excluding the header and epilogue. This message contains ephemeris data of all 12 channels. This table describes the constituents of this message in order.				
<b>Name</b>	<b>Description</b>	<b>Type</b>	<b>Bytes</b>	<b>Values</b>
SV	The satellite to which this data belongs	unsigned short	2	
Spare1	Not used at this time	unsigned short	2	Future use
SecOfWeek	Time at which this arrived (LSB = 6 sec)	unsigned long	4	
SF1words[10]	Unparsed SF 1 message	unsigned long	4x10= 40	
SF2words[10]	Unparsed SF 2 message	unsigned long	4x10= 40	
SF3words[10]	Unparsed SF 3 message	unsigned long	4x10= 40	

## Type 96 Binary Message

**Table 3-6**

This message has a BlockID of 96 and is 300 bytes excluding the header and epilogue. This message contains phase and code data. This table describes the constituents of this message in order.				
Name	Description	Type	Bytes	Values
Spare1	Not used at this time	unsigned short	2	Future use
Week	GPS Week Number	unsigned short	2	
TOW	Predicted GPS Time in seconds	double	8	
UICS_TT_SNR_PRN [12]	See Below	unsigned long	4x12= 48	
UIDoppler_FL [12]	See Below	unsigned long	4x12= 48	
PseudoRange [12]	Pseudo ranges	double	8x12= 96	
Phase [12]	Phase (m) L1 wave length = 0.190293672798365	double	8x12= 96	

where...

### UICS\_TT\_SNR\_PRN

Bits 0-7	PRN (PRN is 0 if no data)
Bits 8-15	SNR value (SNR= 10.0*log10(0.8192*SNR value))
Bits 16-23	Phase Track Time in units of 1/10 second Range = 0 to 25.5 seconds (see next word)
Bits 24-31	Cycle Slip Counter (Increments by 1 every cycle slip with natural rollover after 255)

### UIDoppler\_FL

Bit 0	1 if Valid Phase, 0 otherwise
Bit 1	1 if Track Time > 25.5 seconds, 0 otherwise
Bits 2-3	Unused
Bits 4-31	Signed (two's compliment) Doppler in units of m/sec x 4096. (i.e., LSB=1/4096) Range = +/- 32768 m/sec. Computed as phase change over 1/10 sec.

## Type 97 Binary Message

**Table 3-7**

This message has a BlockID of 97 and is 28 bytes excluding the header and epilogue. This message contains statistics for processor utilization. This table describes the constituents of this message in order.				
Name	Description	Type	Bytes	Values
CPUFactor	CPU utilization factor. Multiply by 450e-6 to get percentage of spare CPU that is available.	unsigned long	4	Positive
MissedSubFrame	The total number of missed subframes in the navigation message since power on.	unsigned short	2	Positive
MaxSubFramePnd	Max subframes queued for processing at any one time.	unsigned short	2	Positive
MissedAccum	The total number of missed code accumulation measurements in the channel-tracking loop.	unsigned short	2	Positive
MissedMeas	The total number of missed pseudorange measurements.	unsigned short	2	Positive
Spare1	Not used at this time	unsigned long	4	Future use
Spare2	Not used at this time	unsigned long	4	Future use
Spare3	Not used at this time	unsigned long	4	Future use
Spare4	Not used at this time	unsigned short	2	Future use
Spare5	Not used at this time	unsigned short	2	Future use

## Type 98 Binary Message

**Table 3-8**

This message has a BlockID of 98 and is 68 bytes excluding the header and epilogue. This message contains data derived from the satellite almanacs. This table describes the constituents of this message in order.				
Name	Description	Type	Bytes	Values
AlmanData	Almanac-derived-data, 8 satellites at a time.	structure array	8 x 8 = 64	See Table 3-9 below
LastAlman	Last almanac processed.	byte	1	0 – 31
IonoUTCVF lag	Flag that is set when ionosphere modeling data is extracted from the GPS subframe 4.	byte	1	0 = not logged 2 = valid
Spare	Not used at this time	unsigned short	2	Future use



*AlmanData Array (from message type 98 above)*

**Table 3-9**

Name	Description	Type	Bytes	Values
DoppHz	Predicted Doppler in Hz for the satellite in question (assuming a stationary satellite).	short	2	
CountUpdate	Number of times the Almanac has changed for this satellite since the receiver was turned on.	byte	1	Positive
SVindex	Channel number (groups of 8)	byte	1	0 – 7 8 – 15 16 – 23 24 – 31
AlmVFlag	Almanac valid flag.	byte	1	0 = not logged 1 = invalid 2 = valid 3 = has data (not yet validated)
AlmHealth	Almanac health from subframe 4 of the GPS message.	byte	1	See ICD-GPS-200
Elev	Elevation angle in	char	1	-90 to 90

**Continued...**

---

**...From previous page**

	degrees.			
Azimuth	$\frac{1}{2}$ the azimuth in degrees.	byte	1	0 to 180 represents 0 to 360 degrees

## Type 99 Binary Message

**Table 3-10**

This message has a BlockID of 99 and is 304 bytes excluding the header and epilogue. This message contains quantities related to the tracking of the individual GPS satellites along with some other relevant data. This table describes the constituents of this message in order.				
Name	Description	Type	Bytes	Values
NavMode2	Navigation Mode Data (lower 3 bits hold the GPS mode, upper bit set if differential is available).	byte	1	Lower 3 bits take on the values 0 = time not valid 1 = no fix 2 = 2D fix 3 = 3D fix Upper bit (bit 7) is 1 if Diff is available
UTCTimeDiff	Whole seconds between UTC and GPS time (GPS minus UTC).	byte	1	Positive
GPSWeek	GPS week associated with this message.	unsigned short	2	0 to 65536
GPSTimeOfWeek	GPS tow (sec) associated with this message.	double	8	0.0 to 604800.0
ChannelData	12 structures ( <b>see next page</b> ) containing tracking data for each of the receiver's 12 channels.	structure array	12 x 24 = 288	See Table 3-11 on next page
ClockErrAtL1	The clock error of the GPS clock oscillator at L1 frequency in Hz.	short	2	-32768 to 32768
Spare	Not used at this time.	unsigned short	2	Future use

↑  
**ChannelData Array (from message type 99 above)**

<b>Table 3-11</b>				
<b>Name</b>	<b>Description</b>	<b>Type</b>	<b>Bytes</b>	<b>Values</b>
Channel	Channel number.	byte	1	0 to 12
SV	Satellite being tracked, 0 == not tracked.	byte	1	0 to 32
Status	Status bit mask (code carrier bit frame...).	byte	1	Bit 0=code lock 1=carrier lock 2=bit lock 3=frame sync 4=frame sync and new epoch 5=channel reset 6=phase lock 7=spare
LastSubFrame	Last subframe processed in the GPS message.	byte	1	1 to 5
EphmVFlag	Ephemeris valid flag.	byte	1	0=not logged 1=invalid 2=valid 3=has data (not yet validated)
EphmHealth	Satellite health from subframe 1 of the GPS message.	byte	1	See ICD-GPS-200
AlmVFlag	Almanac valid flag.	byte	1	0=not logged 1=invalid 2=valid 3=has data (not yet validated)
AlmHealth	Almanac health from subframe 4 of the GPS message.	byte	1	See ICD-GPS-200
Elev	Elevation angle in degrees.	char	1	-90 to 90
Azimuth	½ the azimuth in degrees.	byte	1	0 to 180 represents 0 to 360 degrees
URA	User range error from subframe 1 of the GPS message.	byte	1	See ICD-GPS-200
Spare	Not used at this time.	byte	1	Future use
ClkForSNR	Code Lock Indicator for SNR. To get SNR, take <b>SNR=10.0*log10(409</b>	unsigned short	2	Positive

**Continued...**

...From previous page

	6*CiIForSNR/NOISE_FLOOR) where NOISE_FLOOR = 80000.0.			
DiffCorr	100 times the differential correction for this channel's pseudorange.	short	2	
PosResid	10 times the position residual from the GPS solution for this channel.	short	2	
VelResid	10 times the velocity residual from the GPS solution for this channel.	short	2	
DoppHz	Expected Doppler for this channel in Hz.	short	2	
NCOHz	Carrier track offset for this channel in Hz.	short	2	



---

## 3.5 – DIAG MESSAGES

There is currently only one type of Diagnostic message (Type 1). This ASCII message includes diagnostic information and is output at a 1 Hz rate. This message is controlled with the \$JASC,D1 command. See the command listing section later in this manual for more information on issuing this command.

1 = Lock  
0 = No Lock  
Lock  
Indicator

week

AGC

Doppler  
(Hz)

ARM  
Status

NAV  
Conditions

\$RD1,410213,1052,1551.4890,1,0,39,-611.5,0,1F,1F,0,999999

time of week  
(seconds)

frequency  
in use (MHz)

BER

DDS  
(Hz)

DSP  
Status

Diff  
Status

Use Tables 3-12, 3-13 and 3-14 to translate the **DSP Status**, **ARM Status**, **NAV Conditions** and **Diff Status**.

## DSP and ARM Status Codes

Table 3-12		
Codes	DSP	ARM
01	Carrier Lock	GPS Lock (solid yellow LED 1)
02	BER OK (Viterbi Lock) (solid yellow LED 2)	DGPS Valid Data
04	Use DSPInitFreqOffset (DSP got lock)	Use ARMInitFreqOffset (ARM got lock)
08	Frame Sync	DGPS solution (flashing green LED 3)
10	Track Mode (same as Carrier Lock)	DGPS solution is Good (solid green LED 3)
<p>Once the receiver has locked onto GPS and has a good differential fix, the status code will read <b>1F</b>. 1F is the hexadecimal code that is read. This translates into a true statement for all of the above conditions. The first digit, 1, is from the track mode (10) and F is translated from 08 + 04 + 02 + 01 = 15 or F in hexadecimal. This occurs as a result of all lights being on and DGPS position being accurate.</p>		

## NAV Conditions Codes

Table 3-13	
<p>The NAV Conditions code shown in the example is <b>1678989</b>. Each digit has a specific meaning as described in this table. The range of each digit is from 0 – C in hexadecimal.</p>	
Digit	Meaning
1	The number of satellites with No Differential (This digit will not be shown if the value is 0)
6	The number of satellites with Differential
7	The number of satellites above the Elevation Mask
8	The number of satellites not Tracked Twice
9	The number of satellites with Healthy Ephemeris
8	The number of satellites with Valid Ephemeris
9	The number of satellites with Lock and Carrier Phase

## Diff Status Codes

<b>Table 3-14</b>	
<b>Codes</b>	<b>Warnings</b>
0001	Subscription has expired or an invalid date is in the receiver
0002	Receiver is not in the proper region in which the subscription allows use (which is designed in its parameters)
0004	Receiver is in an invalid region for use
0008	Receiver is reading the incorrect satellite link (usually indicates that you are reading the satellite for a different country)
0010	Remote site not available – please wait
0020	Almanac not received – please wait
0040	Position not supplied by GPS to differential library
0080	Time not supplied by GPS to differential library
8000	May need to wait up to 30 minutes for update from the satellite data
<p>Any combination of the above error codes is possible. The codes will be given as hexadecimal readings (1.e. 1-9 = 1-9, 10 = A, 11 = B, etc.). For instance, if both the Time (0080) and the Almanac (0020) were not available from the GPS, the user would get a reading of 00A0 where A = 8+2 or A = 10 in hexadecimal. This reading would be placed in the third digit from the left. Where '10' can not occupy one digit, 'A' can. When there is no problem(s), the Diff Status will be 0000.</p>	

---

## 3.6 – CRMSS MESSAGES

This ASCII message is only available from a Beacon receiver. It is turned on and off using the Configuration Command \$GPMSK. This message shows the current beacon Signal Strength (SS), SNR, frequency and MSK values. This message can be output at different rates.

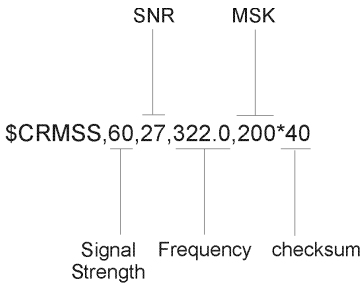

---

## 3.7 – ABOUT SLX COMMANDS

Commands are entered in ASCII. Each command starts with a "\$" and ends with a carriage return – linefeed pair (Return Key).

Commands can serve different purposes, so they have been split into 4 distinct categories.

- ◆ Message Commands
- ◆ Configuration Commands
- ◆ Save and Reset Commands
- ◆ Show Commands

---

In these listings, a table is provided for each command accepted by the SLX receiver. In each table you will find the following information:

**Name** – Command name

**Description** – Brief description of use and purpose

**USE** – Structure of complete command

Text in `COURIER` is to be issued exactly as shown.

Text inside *[brackets]* is optional (do not type the brackets).

Text in *italics* is a parameter.

**PARAMETERS** – Defines parameters that may or may not have to be entered.

**EXAMPLE** – Shows a real life example of the command in use

**REPLY** – Shows the expected reply to the command issued in the Example.

**RECOMMENDED** – A recommended value will be included with some of the command tables that you can feel safe setting to a certain parameter.

---

## 3.8 – ERROR MESSAGES

If an invalid argument or command is issued, the receiver will respond with one of the following error messages:

- ◆ \$>Unrecognized Argument, Please Re-enter
- ◆ \$>Insufficient Arguments, Please Re-enter
- ◆ \$>Invalid Argument, Please Re-enter
- ◆ \$>Invalid Checksum. Please Re-enter
- ◆ \$>Unknown Command, Please Check and Re-enter

## 3.9 – IMPORTANT POINTS

When applicable (as indicated within the table), some commands may be followed by " ,OTHER". The "OTHER" argument indicates that the command will configure the other serial port; **not the one you are issuing the command on.**

Some important points are:

- ◆ Commands are not case sensitive.
- ◆ It is necessary to save any changes to the configuration using the "\$JSAVE" command in order to make it the default upon power-up.
- ◆ Some commands automatically issue a "\$JSAVE" command when sent. This WILL save all configuration changes made since the last power recycle, so be careful when issuing these commands.
- ◆ Changes in configuration may be verified using "\$JSHOW"
- ◆ Some SATLOC Windows' programs turn on or off messages automatically when you enter the program. Always issue a \$JSHOW command before sending the "\$JSAVE" command or you may unknowingly save unwanted changes.

---

## 3.10 – LIST OF COMMANDS

This is an alphabetical listing of all commands (total of 36) you can send to the SLX receiver: Note, however, that some commands will not work with all receivers. This is noted, when appropriate, in the specific commands description.

<b>Command</b>	<b>Page</b>	<b>Command</b>	<b>Page</b>
\$GPMSK	107	\$JGEO	125
\$J4STRING	97	\$JI	126
\$JAGE	108	\$JK	117
\$JAIR	109	\$JLBEAM	127
\$JALT	110	\$JLIMIT	118
\$JAPP	111	\$JLXBEAM	128
\$JASC,BEAC	98	\$JMASK	119
\$JASC,D1	99	\$JOFF	105
\$JASC,GPxxx	100	\$JOMR	129
\$JASC,RTCM	101	\$JOMS	130
\$JASC,VIRTUAL	102	\$JPOS	120
\$JASC,X	103	\$JRESET	122
\$JBAUD	112	\$JSAVE	123
\$JBIN	104	\$JSHOW	131
\$JCONN	113	\$JSHOW,CONF	132
\$JDCO	114	\$JSHOW,GP	133
\$JDIFF	115	\$JT	134
\$JFREQ	116	\$PCSI,1	135

---

## 3.11 – MESSAGE COMMANDS

This group of commands controls the input and/or output of the various message types that the SLX receivers generate and/or recognize.

The message commands are:

- ◆ \$J4STRING
- ◆ \$JASC,BEAC
- ◆ \$JASC,D1
- ◆ \$JASC,GPxxx
- ◆ \$JASC,RTCM
- ◆ \$JASC,VIRTUAL
- ◆ \$JASC,X
- ◆ \$JBIN
- ◆ \$JOFF



---

## **\$J4STRING**

This command turns on four strings of NMEA and turns all other NMEA strings off. Issuing this command turns on the GPGGA, GPVTG, GPGSA, and GPZDA strings at an output rate of one Hz. This command automatically saves the change (issues the \$JSAVE command).

<b>USE</b>
<code>\$J4STRING[ , r][ , OTHER]</code>
<b>PARAMETERS</b>
<code>r = 4800</code> or <code>9600</code> sets the port to this baud rate (omission defaults to 4800)
<b>EXAMPLE</b>
Configure OTHER port to output 4 strings of NMEA at 4800 baud:  <code>\$J4STRING , 4800 , OTHER</code>
<b>REPLY</b>
<code>\$&gt;</code> <code>\$&gt;</code> <code>\$&gt;Saving Configuration. Please Wait...</code> <code>\$&gt;Save Complete</code>  NMEA strings GGA, VTG, GSA, and ZDA will begin outputting at 4800 baud once a second from the other port.

---

## **\$JASC, BEAC**

This command turns on or off RTCM output from the beacon signal. This only works with an SLX-300 receiver.

<b>USE</b>	<code>\$JASC , BEAC , r[ , OTHER]</code>
<b>PARAMETERS</b>	<p><math>r = 0</math> or <math>1</math> where 0 turns beacon RTCM off and 1 turns beacon RTCM on.</p>
<b>EXAMPLE</b>	<p>Configure THIS port to output beacon RTCM:</p> <code>\$JASC , BEAC , 1</code>
<b>REPLY</b>	<p><code>\$&gt;</code></p> <p>Beacon RTCM strings will begin outputting from this port.</p>

---

## \$JASC,D1

This command turns on or off the diagnostic message *x*.

<b>USE</b>
<code>\$JASC ,Dx ,r[ ,OTHER]</code>
<b>PARAMETERS</b>
<p><i>x</i> = <b>1</b> (currently only one diagnostic message type) <i>r</i> = <b>0</b> or <b>1</b> Hz sets the output at this rate (0 turns message off)</p>
<b>EXAMPLE</b>
<p>Configure THIS port to output diagnostic message 1 once a second:</p> <pre>\$JASC ,D1 ,1</pre>
<b>REPLY</b>
<pre>\$&gt;</pre> <p>Diagnostic message 1 will begin outputting once a second from this port.</p> <pre>\$RD1 ,410213 ,1052 ,1551.489 ,1 ,0 ,39 , - 611.5 ,0 ,1F ,1F ,0 ,999999 \$RD1 ,410214 ,1052 ,1551.489 ,1 ,0 ,40 , - 615.1 ,0 ,1F ,1F ,0 ,999999 \$RD1 ,410215 ,1052 ,1551.489 ,1 ,0 ,40 , - 607.1 ,0 ,1F ,1F ,0 ,999999</pre>

## \$JASC,GPxxx

This command turns on or off NMEA message GPxxx at rate *r*.

<b>USE</b>
<code>\$JASC,GPxxx,r[,OTHER]</code>
<b>PARAMETERS</b>
<p><i>xxx</i> = <b>GGA, GLL, VTG, GSV*, RMC, GSA*, ZDA</b> or <b>GST**</b> NMEA message type * Only available at 0.2 or 1 Hz ** Only available at 1 Hz</p> <p><i>r</i> = <b>0, 0.2, 1</b> or <b>5</b> Hz sets the output at this rate (0 turns message off). Set <i>r</i> to <b>MM</b> if you want the receiver to output the GGAxxx selection only once when a manual mark is received.</p>
<b>EXAMPLE</b>
<p>Configure THIS port to output NMEA string type GGA once a second:</p> <pre>\$JASC,GPGGA,1</pre>
<b>REPLY</b>
<p>\$&gt;</p> <p>NMEA string GGA will begin outputting once a second from this port.</p> <pre>\$GPGGA,173302.00,3337.88589,N,11154.69547,W,2,08,1.0,432.6,M,0,M,4.4,0100*7B \$GPGGA,173303.00,3337.88588,N,11154.69548,W,2,08,1.0,432.6,M,0,M,5.4,0100*75 \$GPGGA,173304.00,3337.88589,N,11154.69547,W,2,08,1.0,432.6,M,0,M,6.4,0100*7F \$GPGGA,173305.00,3337.88588,N,11154.69548,W,2,08,1.0,432.5,M,0,M,5.0,0100*74 \$GPGGA,173306.00,3337.88589,N,11154.69547,W,2,08,1.0,432.5,M,0,M,6.0,0100*78</pre>

---

## \$JASC,RTCM

This command turns on or off RTCM message output from the L-Band signal through either port.

<b>USE</b>	<code>\$JASC,RTCM,r[,OTHER]</code>
<b>PARAMETERS</b>	<code>r = 0</code> or <code>1</code> where 0 turns RTCM off and 1 turns RTCM on
<b>EXAMPLE</b>	Configure THIS port to output RTCM messages:  <code>\$JASC,RTCM,1</code>
<b>REPLY</b>	<code>\$&gt;</code>  RTCM message will begin outputting from this port.  Ex.  <code>Y~]vUAQkCQAA@A@Pmlxy_igWAGA@]p ~pXP NlG]AGlUon ARP@`lcSGAABxgBtx]tZl1F oKdQFUUUI</code>

---

## **\$JASC,VIRTUAL**

This command turns on or off virtual RTCM output through either port. Virtual RTCM is simply RTCM being fed in through the other port. Some receivers do not support this command.

<b>USE</b>
<code>\$JASC , VIRTUAL , r [ , OTHER ]</code>
<b>PARAMETERS</b>
<code>r = 0</code> or <code>1</code> where 0 turns this feature off and 1 turns this feature on
<b>EXAMPLE</b>
Configure THIS port to output RTCM messages that are being input through the OTHER port:  <code>\$JASC , VIRTUAL , 1</code>
<b>REPLY</b>
<code>\$&gt;</code>  RTCM messages being input through the other port are now being output through this port.

---

## **\$JASC,X**

This command turns on or off internal debug messages.

<b>USE</b>
<code>\$JASC , X , r [ , OTHER ]</code>
<b>PARAMETERS</b>
<code>r = 0</code> or <code>1</code> where 0 turns debug messages off and 1 turns debug messages on
<b>EXAMPLE</b>
Turn on the output of internal debug messages through THIS port:  <code>\$JASC , X , 1</code>
<b>REPLY</b>
<code>\$&gt;</code>

---

## \$JBIN

This command turns on or off binary message *msg* at rate *r* through either port.

<b>USE</b>
<code>\$JBIN , msg , r [ , OTHER ]</code>
<b>PARAMETERS</b>
<p><i>msg</i> = <b>1, 2, 97*, 98*</b> or <b>99*</b> (more may be added) * Only available at 1 Hz</p> <p><i>r</i> = <b>0, 0.2, 1</b> or <b>5</b> Hz sets the output at this rate (0 turns message off)</p>
<b>EXAMPLE</b>
<p>Configure OTHER port to output Binary message 99 once a second:</p> <pre>\$JBIN , 99 , 1 , OTHER</pre>
<b>REPLY</b>
<pre>\$&gt;</pre> <p>Binary message 99 will begin outputting once a second from the other port.</p>



---

## **\$JOFF**

This command turns off all messages of either port.

<b>USE</b>	<code>\$JOFF[,OTHER]</code>
<b>PARAMETERS</b>	none
<b>EXAMPLE</b>	Shut off all messages that are being output through THIS port:  <code>\$JOFF</code>
<b>REPLY</b>	<code>\$&gt;</code>  All messages except text messages are turned off for this port.

---

## 3.12 - CONFIGURATION COMMANDS

This group of commands controls the many settings that control operation of the SLX. These affect the settings that can be changed. A \$JSAVE command must be issued after these commands and before powering down the receiver for them to be made permanent.

The configuration commands are:

- ◆ \$GPMSK
- ◆ \$JAGE
- ◆ \$JAIR
- ◆ \$JALT
- ◆ \$JAPP
- ◆ \$JBAUD
- ◆ \$JCONN
- ◆ \$JDICO
- ◆ \$JDIFF
- ◆ \$JFREQ
- ◆ \$JK
- ◆ \$JLIMIT
- ◆ \$JMASK
- ◆ \$JPOS

## \$GPMSK

This command controls the frequency and MSK selection (bit rate) of the Beacon receiver. It is possible to set either or both to manual or automatic.

<b>USE</b>	$\$GPMSK, freq, u, msk, v[, r]$
<b>PARAMETERS</b>	<p><i>freq</i> = frequency setting of beacon receiver (leave blank if choosing Automatic <i>u</i>).</p> <p><i>u</i> = <b>M</b> or <b>A</b> where M is Manual frequency setting and A is Automatic frequency setting.</p> <p><i>msk</i> = MSK value of beacon receiver (leave blank if choosing Automatic <i>v</i>)</p> <p><i>v</i> = <b>M</b> or <b>A</b> where M is Manual MSK setting and A is Automatic MSK setting.</p> <p><i>r</i> = message repeat value (repeats every <i>r</i> seconds)</p>
<b>EXAMPLE</b>	<p>Set frequency to 322.0 and MSK to automatic and CRMSS message to output every 2 seconds:</p> $\$GPMSK, 322.0, M, , A, 2$
<b>REPLY</b>	$\$PCSI, ACK, GPMSK, 322.0, M, , A, 2$ $\$CRMSS, 60, 27, 322.0, 200*40 \quad (\text{every 2 seconds})$
<b>RECOMMENDED</b>	<p>Set both frequency and MSK to automatic.</p>

---

## **\$JAGE**

This command sets the age at which the differential correctors will time out.

<b>USE</b>	<code>\$JAGE , <i>age</i></code>
<b>PARAMETERS</b>	<code><i>age</i></code> = time in seconds in which differential corrections will time out
<b>EXAMPLE</b>	Set timeout age to 30 seconds:  <code>\$JAGE , 30</code>
<b>REPLY</b>	<code>\$&gt;</code>
<b>RECOMMENDED</b>	Set time-out to 60 seconds if unsure.

---

## \$JAIR

This command turns on or off air mode so that the receiver responds better to higher dynamics and signal fades. The default setting is an automatic mode where air mode turns on above 30 m/s. If a \$JSAVE command is issued after the \$JAIR, the only way to go back to the automatic mode is to issue the \$JRESET command.

<b>USE</b>
<code>\$JAIR, <i>m</i></code>
<b>PARAMETERS</b>
<code><i>m</i> = 0 or 1</code> where 0 turns off air mode and 1 turns on air mode
<b>EXAMPLE</b>
Turn on air mode:  <code>\$JAIR, 1</code>
<b>REPLY</b>
<code>\$&gt;Air Mode: ON</code>
<b>RECOMMENDED</b>
Set air mode to automatic if unsure. This requires using the \$JRESET command.

---

## \$JALT

This command configures the altitude aiding option. Altitude aiding improves system accuracy using an artificial reference point.  $v$  varies in type depending on  $c$ . **Caution:** This command is meant for marine applications where operating altitude does not change. Use of this command in varying altitudes will result in inaccurate  $x - y$  positions.

<b>USE</b>
$\$JALT, c, v$
<b>PARAMETERS</b>
$c =$ <b>NEVER, ALWAYS</b> or <b>SOMETIMES</b> $v =$ ignored (if NEVER), altitude in meters (if ALWAYS), PDOP threshold (if SOMETIMES)
<b>EXAMPLE</b>
Turn altitude aiding on when the PDOP is above 4.0: $\$JALT, SOMETIMES, 4.0$
<b>REPLY</b>
$\$>$
<b>RECOMMENDED</b>
Set altitude aiding to <b>NEVER</b> if unsure.

---

## **\$JAPP**

This command is used when you want to switch between using an OmniSTAR L-Band subscription and the free WAAS L-Band service. This command only is available on the newest SLX receivers.

<b>USE</b>
<code>\$JAPP , m</code>
<b>PARAMETERS</b>
<code>m = 1</code> or <code>2</code> where 1 selects OmniSTAR and 2 selects WAAS.
<b>EXAMPLE</b>
Set L-Band selection to WAAS:  <code>\$JAPP , 2</code>
<b>REPLY</b>
<code>\$&gt;</code>

---

## \$JBAUD

This command configures the baud rate of communication for either port.

<b>USE</b>
<code>\$JBAUD , r [ , OTHER ]</code>
<b>PARAMETERS</b>
<code>r = <b>4800</b>, <b>9600</b> or <b>19200</b></code> which is the desired baud rate
<b>EXAMPLE</b>
Configure OTHER port to 4800 baud:  <code>\$JBAUD , 4800 , OTHER</code>
<b>REPLY</b>
<code>\$&gt;</code>
<b>RECOMMENDED</b>
Set port A to 4800 if unsure. Set port B to 19200 if unsure.



---

## \$JCONN

This command establishes a virtual connection between two ports. Some receivers do not support this command.

<b>USE</b>
$\$JCONN, p$
<b>PARAMETERS</b>
$p = \mathbf{C}, \mathbf{AB}$ or $\mathbf{X}$ . C connects the current port to port C (internal DSP port). AB connects port A and port B together, meaning, data going into one port will be output through the other port. X disconnects the ports.
<b>EXAMPLE</b>
Connect Port A and Port B together: $\$CONN, AB$
<b>REPLY</b>
$\$>$
<b>RECOMMENDED</b>
Set this value to X to disconnect the ports if unsure.

---

## \$JDCO

This command sets the frequency offset of the TCXO (at L1) stored in the ARM. This setting will only be used if the ARM does not have a navigation solution. This command should only be used by those with experience. It is typically for recovering from corrupted memory.

<b>USE</b>
<code>\$JDCO , v</code>
<b>PARAMETERS</b>
<code>v</code> = frequency offset as a double in Hz
<b>EXAMPLE</b>
Zero the TCXO value: <code>\$JDCO , 0 . 0</code>
<b>REPLY</b>
<code>\$&gt;</code>  If the receiver has already acquired lock, you will receive this reply: <code>\$&gt;GPS Already has lock</code>

---

## \$JDIFF

This command selects the source of differential. Selecting THIS or OTHER requires RTCM input through that port.

<b>USE</b>
<code>\$JDIFF , option</code>
<b>PARAMETERS</b>
<code>option = THIS, OTHER, BEACON or LBAND</code> selects a port as source of differential. THIS and OTHER are for using external sources of differential. BEACON and LBAND are for using internal sources of differential. BEACON only works with an SLX-300. WAAS receivers use LBAND setting.
<b>EXAMPLE</b>
Selects the L-Band from the SLXg as the source of differential: <code>\$JDIFF , LBAND</code>
<b>REPLY</b>
<code>\$&gt;</code>
<b>RECOMMENDED</b>
Set the diff source to LBAND if unsure.

## \$JFREQ

This command forces the differential frequency and symbol rate to set values and will stop using spot beam tables. Set the frequency to 0 kHz to re-enable use of automatic spot beam tables. This command can also be issued, to newer receivers, without the parameters to send the \$JLBEAM command that returns information about the spot beam.

<b>USE</b>
$\$JFREQ, kHz, r$
<b>PARAMETERS</b>
$kHz$ = L-Band frequency in kHz or <b>0</b> to re-enable auto-selection with spot beam tables $r$ = <b>1200</b> or <b>2400</b> baud symbol rate
<b>EXAMPLE</b>
Force the receiver to 1551.489 MHz and a symbol rate of 1200:  $\$JFREQ, 1551489, 1200$  Note: 1551.489 MHz = 1551489 kHz
<b>REPLY</b>
$\$>$
<b>RECOMMENDED</b>
Set the frequency to 0 if unsure, thus enabling the spot beam tables which automatically select the beam frequency you should use.

---

## \$JK

This command can be used to display the subscription expiration date, or to enter a code that will set a new subscription.

<b>USE</b>
<code>\$JK[ , <i>code</i>]</code>
<b>PARAMETERS</b>
<i>code</i> = 20-digit code obtained through OmniSTAR that will activate a new subscription. Not including the code will return the current expiration date
<b>EXAMPLE</b>
Show current expiration date:  <code>\$JK</code>
<b>REPLY</b>
<code>\$&gt;JK, 12/31/1999</code>

---

## **\$JLIMIT**

This command sets the residual threshold for the Green LED light.

<b>USE</b>	<code>\$JLIMIT, v</code>
<b>PARAMETERS</b>	<p><math>v</math> = from 1.0 to 50.0 meters. The receiver will not become solid until you have obtained differential and the rms pseudo-range residual is less than <math>v</math>. Default = 10.0 meters</p>
<b>EXAMPLE</b>	<p>Set green LED light threshold to 2 meters:</p> <pre>\$JLIMIT, 2.0</pre>
<b>REPLY</b>	<pre>\$&gt;</pre>
<b>RECOMMENDED</b>	<p>Set this limit to 10.0 meters if unsure.</p>

---

## **\$JMASK**

This command configures the elevation mask. The SLXg will not use any satellites that are beneath the set elevation mask on the horizon.

<b>USE</b>	<code>\$JMASK , e</code>
<b>PARAMETERS</b>	<code>e</code> = degrees from 0 to 60. Default = 0.0
<b>EXAMPLE</b>	Use a 5 degree mask: <code>\$JMASK , 5</code>
<b>REPLY</b>	<code>\$&gt;</code>
<b>RECOMMENDED</b>	Set the elevation mask to 5 degrees if unsure.

---

## \$JPOS

This command allows you to define your current position and can speed up the time it takes to find a spot beam when in auto freq mode. By entering a location that is inside the desired spot beam, the SLX does not have to wait until it computes a GPS position to choose a spot beam. This is good for first time startups in a new spot beam. As soon as GPS calculates a new position, the entered position will be overwritten.

<b>USE</b>
<code>\$JPOS , Lat , Lon</code>
<b>PARAMETERS</b>
<i>Lat</i> = Latitude in degrees with South being negative <i>Lon</i> = Longitude in degrees with West being negative
<b>EXAMPLE</b>
Set startup position to 33.11°, -111.25°:  <code>\$JPOS , 33 . 11 , -111 . 25</code>
<b>REPLY</b>
<code>\$&gt;</code>
<b>RECOMMENDED</b>
Use this command if you are having to wait too long after powering up your receiver in a new spot beam. This is usually not a problem, though.



---

## 3.13 – RESET and SAVE COMMANDS

These two commands are necessary and important, which is why they have their own section.

The reset and save commands are:

- ◆ \$JRESET
- ◆ \$JSAVE

---

## \$JRESET

This command is used to reset SLXg configuration to default.

This is equivalent to issuing the following commands:

\$JLIMIT, 10

\$JMASK, 5

\$JALT, NEVER, 0

\$JAGE, 60

\$JOFF

\$JOFF, OTHER

and \$JSAVE to save changes.

### USE

\$JRESET[, ALL]

### PARAMETERS

**ALL** will also reset the Almanacs and clear spot beams to defaults

### EXAMPLE

Clear only the user configuration:

```
$JRESET
```

### REPLY

```
$>
```

```
$>
```

```
$>Saving Configuration. Please Wait
```

```
$>Save Complete
```

```
$>
```

```
$>
```

```
$>
```

---

## **\$JSAVE**

This command saves configuration and message settings. Not issuing this command after other configuration changes will reset the changes when powered down. Be careful when using this command. It is a good idea to issue a \$JSHOW command before saving to check the configuration that you are about to save.

<b>USE</b>	<code>\$JSAVE</code>
<b>PARAMETERS</b>	none
<b>EXAMPLE</b>	Save setting changes:  <code>\$JSAVE</code>
<b>REPLY</b>	<code>\$&gt;</code> <code>\$&gt;Saving Configuration. Please Wait</code> <code>\$&gt;Save Complete</code>

---

## 3.14 – SHOW COMMANDS

This group of commands simply shows or returns information to the user. No changes can be made to the receiver with these commands.

The show commands are:

- ◆ \$JGEO
- ◆ \$JI
- ◆ \$JLBEAM
- ◆ \$JLXBEAM
- ◆ \$JOMR
- ◆ \$JOMS
- ◆ \$JSHOW
- ◆ \$JSHOW,CONF
- ◆ \$JSHOW,GP
- ◆ \$JT
- ◆ \$PCSI,1

---

## \$JGEO

This command displays the current L-Band satellite information. WAAS receivers do not support this command.

<b>USE</b>	<pre>\$JGEO</pre>
<b>EXAMPLE</b>	<p>Show GEO information:</p> <pre>\$JGEO</pre>
<b>REPLY</b>	<pre>\$&gt;JGEO,Sent=1551.4890,Used=1551.4890,Baud=1200,Lon=-101,El=50.0,Az=160.8</pre> <p>In the form...</p> <pre>\$&gt;JGEO,Sent={Frequency sent to DSP},Used={Frequency used by DSP},Baud={Data Rate},Lon={Longitude of satellite},El={Elevation of satellite in degrees},Az={Azimuth of satellite with 0 degrees being North}</pre>

---

## \$JI

This command displays the receiver information.

<b>USE</b>
\$JI
<b>EXAMPLE</b>
Show receiver info:  \$JI
<b>REPLY</b>
\$>JI,810133,1,3,09031998,01/06/1980,12 /31/2000,3.3,31  In the form...  \$>JI,{Receiver serial number},{Fleet number}, {Hardware version},{Production date code}, {Subscription begin date},{Subscription expiration date},{ARMversion},{DSP version}

## \$JLBEAM

This command displays the information of each spot beam and which is currently in use.

<b>USE</b>	<code>\$JLBEAM</code>
<b>EXAMPLE</b>	<p>Show spot beam information:</p> <pre>\$JLBEAM</pre>
<b>REPLY</b>	<pre>\$&gt;JLBEAM,Sent 1551.4890,Used     1551.4890,Baud 1200,Geo -101 \$&gt;JLBEAM,1556.8250,-88,45,1200,(-101) \$&gt;JLBEAM,1554.4970,-98,45,1200,(-101) \$&gt;JLBEAM,1551.4890,-108,45,1200,(-101) \$&gt;JLBEAM,1531.2300,25,50,1200,(16) \$&gt;JLBEAM,1535.1375,-75,0,1200,(-98) \$&gt;JLBEAM,1535.1525,20,6,1200,(25) \$&gt;JLBEAM,1558.5100,144,-20,1200,(160) \$&gt;JLBEAM,1535.1375,90,8,1200,(109)</pre> <p>Where the first line represents the satellite being used, in the form...</p> <pre>\$&gt;JLBEAM,Sent {Frequency sent to DSP},Used     {Frequency used by DSP},Baud {Symbol Rate},Geo     {Longitude of satellite}</pre> <p>And the remaining lines show the other spot beams, in the form...</p> <pre>\$&gt;JLBEAM,{Spot beam frequency},{Longitude of spot     beam center coordinate},{Latitude of spot beam center     coordinate},{Symbol rate},{Longitude of satellite}</pre>

---

## \$JLXBEAM

This command displays debug information for spot beam updates. Not available with Beacon and WAAS receivers.

### USE

\$JLXBEAM

### EXAMPLE

Show spot beam debug information:

\$JLXBEAM

### REPLY

```
$>JLBEAMEX,0
$> Table:0
$> Beam:0,1753247034,-88,45,1200,-101
$> Beam:1,1750643210,-98,45,1200,-101
$> Beam:2,1747278819,-108,45,1200,-101
$> Beam:3,1724619511,25,50,1200,16
$> Beam:4,1728989976,-75,0,1200,-98
$> Beam:5,1729006753,20,6,1200,25
$> Beam:6,1755131675,144,-20,1200,160
$> Beam:7,1728989976,90,8,1200,109
$> Table:1
```

The reply first shows the spot beam table number in use and then shows beam information for each spot beam table in memory, in the form...

```
$>JLBEAMEX,{Table index in use}
$> Table:{Table index}
$> Beam:{Beam index},{DDS frequency},{Longitude of
spot beam center coordinate},{Latitude of spot beam
center coordinate},{Symbol rate},{Longitude of satellite}
```



---

## \$JOMR

This command will display raw OmniSTAR region information. It lists the inclusion area covered by the OmniSTAR signal subscription, and any exclusion areas inside of that. Not available with Beacon and WAAS receivers.

<b>USE</b>
\$JOMR
<b>EXAMPLE</b>
Show region information:  \$JOMR
<b>REPLY</b>
<pre>\$&gt;JOMR,1,0.994787,-1.605694,4500000.000 \$&gt;JOMR,2,0.000000,0.000000,0.000000 \$&gt;JOMR,3,0.000000,0.000000,0.000000 \$&gt;JOMR,4,0.000000,0.000000,0.000000 \$&gt;JOMR,5,0.000000,0.000000,0.000000</pre> <p>If your receiver has an active subscription, the first line should show the inclusion area, in the form...</p> <p>\$&gt;JOMR,{Region index},{Latitude in radians},{Longitude in Radians},{Radius in meters}</p> <p>The other lines will list any other inclusion/exclusion zones. Negative radius values mean that the region is an exclusion area.</p>

---

## \$JOMS

This command will display OmniSTAR subscription information. Not available with Beacon and WAAS receivers.

<b>USE</b>
<code>\$JOMS</code>
<b>EXAMPLE</b>
Display subscription information:  <code>\$JOMS</code>
<b>REPLY</b>
<code>\$&gt;JOMS,DRY,ALL,VBS,0,01/06/1980,01/06/1980,0,0,1E00,1.41</code>
In the form...
<code>\$&gt;JOMS,{SubOptions},{Source},{SolutionType},{AccuracyReduction},{Subscription start date},{Subscription end date},{HourGlass},{ExtentionTime},{LinkVector},{OmniSTAR Library Version}</code>
Where...
SubOptions = WET or DRY Source = The RTCM source; ID or ALL if VBS SolutionType = VBS, VRC or SINGLE_SITE Accuracy Reduction = 0 is most accurate HourGlass = Seconds of metered time ExtentionTime = Seconds of extention LinkVector = hex bit mask OmniSTAR Library Version = Receiver version number

---

## **\$JSHOW**

This command will display the current port and receiver configurations.

	<p><b>USE</b></p> <p>\$JSHOW</p>
	<p><b>EXAMPLE</b></p> <p>Show system configuration:</p> <p>\$JSHOW</p>
	<p><b>REPLY</b></p> <pre>\$&gt;JSHOW,BAUD,19200 \$&gt;JSHOW,BIN,1,5.0 \$&gt;JSHOW,BAUD,4800,OTHER \$&gt;JSHOW,ASC,GPGGA,1.0,OTHER \$&gt;JSHOW,ASC,GPVTG,1.0,OTHER \$&gt;JSHOW,ASC,GPGSA,1.0,OTHER \$&gt;JSHOW,ASC,GPZDA,1.0,OTHER \$&gt;JSHOW,DIFF,LBAND \$&gt;JSHOW,ALT,NEVER \$&gt;JSHOW,LIMIT,10.0 \$&gt;JSHOW,MASK,5 \$&gt;JSHOW,POS,33.6,-111.9 \$&gt;JSHOW,AIR,AUTO,OFF \$&gt;JSHOW,FREQ,0 \$&gt;JSHOW,AGE,60</pre> <p>This reply varies according to the configuration of your SLX. The first line shows the baud rate of THIS port and under that shows any message types that may be turned on for that port. Then it shows the baud rate of the OTHER port and any message types that may be turned on for that port. Then it shows the current status of the following eight commands: \$JDIFF, \$JALT, \$JLIMIT, \$JMASK, \$JPOS, \$JAIR, \$JFREQ, \$JAGE.</p>

---

## \$JSHOW,CONF

This command also shows configuration information. The information in this string can also be found in the \$JSHOW reply but is in a condensed form here.

### USE

\$JSHOW,CONF

### EXAMPLE

Show configuration information:

\$JSHOW,CONF

### REPLY

\$>JSHOW,CONF,N,0.0,10.0,5,A,0,60,L

In the form...

\$>JSHOW,CONF,{N, S or A},{0.0/PDOP/Height},  
{Residual Limit},{Elevation Mask},{M or A for Air  
Mode},{Air Mode On or Off},{Max Diff Age},{Diff Source}

Where...

N, S or A = NEVER, SOMETIMES or ALWAYS in regards to  
Altitude Aiding. See \$JALT.

0.0/PDOP/Height = Value used for Altitude aiding See \$JALT.

Residual Limit = Value used to control Green LED. See  
\$JLIMIT.

Elevation Mask = Angle in degrees. See \$JMASK.

M or A for Air Mode = Manual or Automatic. See \$JAIR.

Air Mode On or Off = 0 for Off and 1 for On. See \$JAIR.

Max Diff Age = ranges from 6 to 120. See \$JLIMIT.

Diff Source = T, O, B, W or L for This, Other, Beacon, WAAS  
or L-Band. See \$JDIFF.

---

## **\$JSHOW,GP**

This command lists the current NMEA outputs of a certain port.

<b>USE</b>	<pre>\$JSHOW,GP</pre>
<b>EXAMPLE</b>	<p>Show NMEA output of the OTHER port:</p> <pre>\$JSHOW,GP,OTHER</pre>
<b>REPLY</b>	<pre>\$&gt;\$JSHOW,GP,GGA,1.0,GLL,1.0,VTG,1.0,GSV,1.0 ,GSA,1.0,ZDA,1.0,RMC,1.0,GST,1.0,OTHER</pre> <p>This shows that all eight NMEA types are on, on the OTHER port, at 1 Hz output rate (once a second). Fields will be omitted if they are not on.</p>

---

## **\$JT**

This command will display the receiver type.

	<b>USE</b>  \$JT
	<b>EXAMPLE</b>  Show the receiver type:  \$JT
	<b>REPLY</b>  \$>JT , SLXg

---

## \$PCSI,1

This command shows current state of the Beacon receiver. It shows values associated to the first channel.

<b>USE</b>
<code>\$PCSI,1[,i]</code>
<b>PARAMETERS</b>
<code>i</code> = Status message repeat interval (repeats every <code>i</code> seconds)
<b>EXAMPLE</b>
Show beacon information once:  <code>\$PCSI,1</code>
<b>REPLY</b>
<pre>\$&gt;PCSI,ACK,1 \$&gt;PCSI,CS0,P003-5.009,19001,322.0,M,200,M, 59,27,100,25,268,0,0</pre>
Where...
\$>PCSI,ACK,1 is an acknowledgement that the receiver received the command,
and the next line is in the form...
\$>PCSI,{Channel number},{Beacon receiver firmware}, {Beacon receiver serial number},{frequency},{M or A for beacon frequency mode},{MSK},{ M or A for beacon MSK mode },{Signal Strength},{SNR},{Mean throughput %},{RTCM Quality, 0-25},{Beacon ID},{Health ID},{message repeat interval}

---

# Frequently Asked Questions

---

## GENERAL

### **Q. How do I get L-Band service?**

L-Band service is available by contacting OmniSTAR, INC and purchasing an L-Band Service Subscription for use with the SATLOC SLX receiver. OmniSTAR can be contacted by:

Phone: (713) 785-5850  
1-888-666-4782 (toll free)  
Fax: (713) 785-5164  
Mail: 8200 Westglen  
Houston, TX 77063  
USA  
E-mail: dgps2@omnistar.com  
Internet: <http://www.omnistar.com>

### **Q. Where is 300 kHz beacon signal available?**

Beacon signal is broadcast from transmission towers around the world. To find out if you are within range of a tower, please visit our website:

<http://www.satloc.com/beacon.stm>



---

**Q. What is WAAS, how do I get it and when can I start using it?**

WAAS is a free Differential source. WAAS (Wide Area Augmentation System) is a system of GPS data stations located throughout the United States (Alaska, Hawaii and Puerto Rico included) that collect GPS data and solve for Differential corrections. This correction data is sent via satellite back to WAAS capable GPS receivers.

SATLOC receivers must be programmed to be WAAS capable. This can be done at time of purchase or later in the field by an authorized technician.

WAAS is scheduled to be fully operational by 2001. It does currently operate daily but is not guaranteed to be stable until the government officially introduces it as such.

**Q. Can my SLX-300 receiver be upgraded to receive WAAS Differential?**

Yes, the SLX-300 is able to receive WAAS Differential, but only if it was upgraded to do so. If you did not buy the receiver with WAAS enabled, your dealer will have to upgrade the firmware inside the receiver to enable WAAS.

**Q. I have an SLXg receiver, can I receive 300 kHz Beacon signal?**

No, the SLXg receiver is only capable of receiving the GPS and L-Band Differential signals. It also can be upgraded to receive the WAAS Differential when available. In order to receive 300 kHz Beacon Differential, you need to buy the SLX-300 receiver.

**Q. Do the SLXg, SLXg with WAAS and SLX-300 receivers use the same antenna?**

No, the SLX-300 requires the new SATLOC W3 antenna that includes the ability to receive 300kHz Beacon

---

signals. The SLXg and SLXg with WAAS both use the original SATLOC L-Band antenna. The new W3 antenna will work with any of the receivers but is designed specifically for the SLX-300.

**Q. Can I use my receiver in Europe?**

Yes, you can use OmniSTAR signal, 300 kHz Beacon (with an SLX-300), or the European EGNOS Differential which is similar to WAAS.

**Q. Can I purchase additional cables from SATLOC?**

Yes, even though the SATLOC receivers are always sold with the necessary cables, you may purchase additional cables to match your needs. Contact your local dealer for more information.

**Q. Who do I contact for Service?**

Contact your local dealer or go to SATLOC's website for a list of authorized Service Centers.

[http://www.satloc.com/service\\_1.stm](http://www.satloc.com/service_1.stm)

## COMMUNICATION

**Q. My receiver does not seem to be communicating. What do I do?**

Check the following:

- ◆ Connect to a peripheral running a communications program.
- ◆ Verify that your peripheral device is connected to the correct port.
- ◆ Verify that the baud rate on the receiver matches with that on your peripheral.
- ◆ Enter the \$J1 command and confirm that you receive a response.

---

## Q. What if I can't communicate with the receiver?

A great way to establish communication with your receiver is to reset the port settings using the SLXg DIAG program. This technique only requires that you have a working receiver and that you know which of your computer's COM ports you are connected to. To reset the port settings, do the following:

- ◆ Connect SLX Port B to a COM port on your computer and run the SLXg DIAG program.
- ◆ Turn on SLX receiver.
- ◆ Click the **SETUP** button, choose a COM port and then choose the settings you wish to set up.
- ◆ Write down the new port settings for future reference.

## Q. Can the SLX receivers output through two different ports at different baud rates?

Yes. Not only can they output through two different ports simultaneously, but also can output separate messages to each port set at different baud rates.

## Q. How can I find out how my ports are set up?

If you can communicate with the receiver, issue the \$JSHOW command. The first few lines of the reply show the baud rates and message output of both ports.

```
$>JSHOW,BAUD,19200
$>JSHOW,BIN,1,5.0
$>JSHOW,BAUD,4800,OTHER
$>JSHOW,ASC,GPGGA,1.0,OTHER
$>JSHOW,ASC,GPVTG,1.0,OTHER
$>JSHOW,ASC,GPGSA,1.0,OTHER
$>JSHOW,ASC,GPZDA,1.0,OTHER
```

The above example says that the port you are connected to is set at a 19200 baud rate and is outputting BIN message 1 at 5Hz. It then says that the

---

OTHER port is set at a 4800 baud rate and is outputting the GGA, VTG, GSA and ZDA NMEA strings at 1Hz.

**Q. Do I need 10 Hz output?**

No, the SLX receivers output at rates up to 5 Hz (5 times a second). This is fast for most applications. Many of the messages from the GPS can't even output faster than 1 Hz, due to the amount of data being computed and transmitted. A position update 5 times a second is fast and suitable for any of your applications.

## GPS

**Q. How do I know if my receiver has GPS?**

The easiest way is to look at the status LEDs on the SLX. If the 1<sup>st</sup> Yellow LED, closest to the Red LED, is lit up solid (not blinking) then the receiver has GPS LOCK.

**Q. Can I lose GPS LOCK once I have it?**

It is possible to lose GPS LOCK, for instance, if you have less than 4 satellites.

## DIFFERENTIAL

**Q. How long does it take to get Diff?**

On a normal power-up, it should only take the receiver a few minutes to get Diff LOCK. However, if it is the first time a receiver has been powered up in a new region or if the almanac has been reset, it can take up to 30 minutes to acquire Differential.

**Q. How do I know if my receiver has Diff?**

The best way to tell if your receiver has Diff is to look at the status LEDs. Look to see that the 2<sup>nd</sup> Yellow LED is solid. This means that the receiver has Diff LOCK.

---

### **Q. What is the accuracy of my receiver?**

The positions computed by your receiver are accurate to within 1 meter 66% of the time (assuming a good view of the sky and minimal multipath). A static test can be performed to test what is called drift to see the accuracy of your receiver over long lengths of time. Set up the receiver to run overnight or all day long and make sure the antenna is not moved during the length of the test. Then, connect to SLXMon and choose **Log Data** from the *File* menu. This will start logging data once a second to a file that can be graphed or sent to your dealer/service center to graph.

## LEDs

### **Q. No LEDs light up, what is the problem?**

- ◆ Check to make sure you have 9-36 Volts feeding the receiver.
- ◆ All installations require a fuse or circuit breaker. Check the condition of this device.

### **Q. Only one of the Yellow LEDs lights up, what does this mean?**

The Yellow LED closest to the Red power LED is the GPS indicator. If this is turned off, the receiver is not tracking satellites. If the LED closest to the Green LED is not on, the receiver has not obtained differential LOCK.

### **Q. The Green LED doesn't light up, what can I do?**

- ◆ If there are any obstructions (Trees, Buildings, ...) move the antenna in clear view of the sky and horizon.
- ◆ You may be experiencing a temporary satellite orbit condition. In this case the only thing to do is wait until more satellites are in view of the receiver. This

---

can take anywhere from 15 minutes to several hours.

## INSTALLATION

### **Q. Does it matter where the DGPS antenna is mounted?**

Yes. Remember, the positional data being output by the receiver is based on the location of the antenna, not the receiver.

### **Q. Can I connect my receiver to an isolated battery?**

Yes, however, regularly check to make sure that the battery is sufficiently charged. The receiver must have at least 9 Volts D.C. to function.