

SOKKIA

LDT5 LDT5S

Electronic Laser Digital Theodolite

—— Do not look directly into
the laser beam source ——

(Class II laser product)

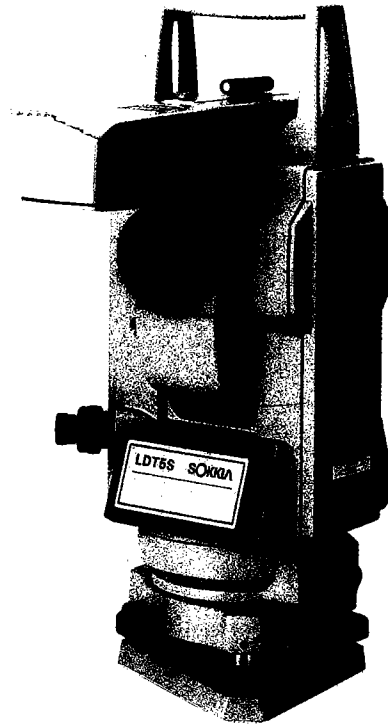

OPERATOR'S MANUAL

LASER SAFETY INFORMATION

CLASS II LASER PRODUCT

- 1) DO NOT LOOK DIRECTLY INTO THE LASER BEAM SOURCE.
- 2) Do not point the laser beam at other people, and use well above or below eye level.
- 3) Before switching on the LDT5, and while the laser beam is not required, ensure that the laser shutter is closed (set to the white spot position).
- 4) The beam should be blocked by a non-reflecting target at the end of its useful path.
- 5) When used in low light conditions, a laser light interference pattern may be seen in the telescope field of view. However, this interference does not affect the safety or angle measurement accuracy of the instrument.
- 6) When the laser beam shutter is opened (turned to the red spot position), there may be some delay before the laser beam is output. In this situation, turn the shutter to the white position and then back to the red position to output the beam sooner.
- 7) Personnel exposed to the laser beam at close range are advised to wear eye protection for Helium-Neon radiation. e.g. Yamamoto kougaku YL-110 (M) glasses or equivalent.
- 8) It is recommended that the LDT5 is checked by a qualified service man once a year.

A LASER WARNING LABEL DIAGRAM CAN BE FOUND ON PAGE 3.

WARNING

- Use of controls or adjustments, or performance of procedures other than those specified in this manual, may result in hazardous radiation exposure.
- If the LDT5 is subjected to heavy shock and it is suspected that the laser tube may have been damaged, immediately disconnect the power source and consult your Sokkisha agent.
- A high voltage circuit is contained in the instrument. Do not attempt to open or disassemble the instrument.

CONTENTS

1. PRECAUTIONS	1
2. PARTS OF THE INSTRUMENT	1
3. LASER WARNING LABELS	3
4. QUICK GUIDE TO LDT5 OPERATION	4
5. DISPLAY SYMBOLS/KEY FUNCTIONS	5
6. SETTING UP THE INSTRUMENT	6
6.1 Centring and levelling	6
6.2 Focussing and target sighting	8
7. CONNECTING THE POWER SUPPLY	10
8. INDEXING THE VERTICAL CIRCLE	12
9. LASER BEAM OUTPUT AND ANGLE MEASUREMENT ..	13
9.1 Reading the horizontal and vertical angle	14
9.2 Set horizontal angle to zero	15
9.3 Lay out a required horizontal angle	15
9.4 Measure the horizontal angle between two targets ..	15
9.5 Hold the horizontal angle value	16
9.6 Set the horizontal circle to a required value	16
9.7 Select the horizontal angle right or left	16
9.8 % vertical angle mode	17
9.9 Display and reticle illumination	17
10. ERROR CODES	18
11. OPTICAL DISTANCE MEASUREMENT: STADIA SURVEY ..	19
12. CHECKS AND ADJUSTMENTS	20
12.1 Plate level	20
12.2 Circular level	21
12.3 Telescope level	22
12.4 Reticle	23
12.5 Optical plummet	27
13. INSTRUMENT INTERNAL PARAMETER SWITCHES ..	28
APPENDICES	
A. Indexing vertical circle by face left, face right readings	29
B. Standard accessories	30
C. Optional accessories	31
SPECIFICATIONS/STANDARD EQUIPMENT	35
MAINTENANCE	38

1. PRECAUTIONS

- a) When the LDT5 is not used for a long time, check it at least once every three months.
- b) Handle the LDT5 with care. Avoid heavy shocks or vibration.
- c) If any problems are found with the rotatable portion, screws or optical parts (e.g. lens), contact your Sokkisha agent.
- d) After removing the LDT5 from the carrying case, close the case to exclude dust.
- e) Never place the LDT5 directly on the ground. (Attached dirt may damage the base plate and centring screw.)
- f) Never carry the LDT5 on the tripod to another site.
- g) Protect the LDT5 with an umbrella against strong sunlight and rain.
- h) When the operator leaves the LDT5, the vinyl cover should be placed over the instrument.
- i) Always switch the power off before disconnecting the power source.
- j) Always disconnect the power cable from the LDT5 before returning it to the case.
- k) When the LDT5 is placed in the carrying case, follow the layout plan.
- l) Make sure that the LDT5 and the protective lining of the carrying case are dry before closing the case. (The case is hermetically sealed; if moisture is trapped inside, damage to the instrument could occur.)

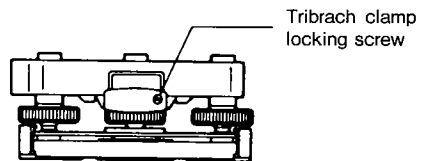

IMPORTANT

When the LDT5 leaves our factory, the tribrach clamp is locked with a screw. Loosen it and leave it loose.

2. PARTS OF THE INSTRUMENT

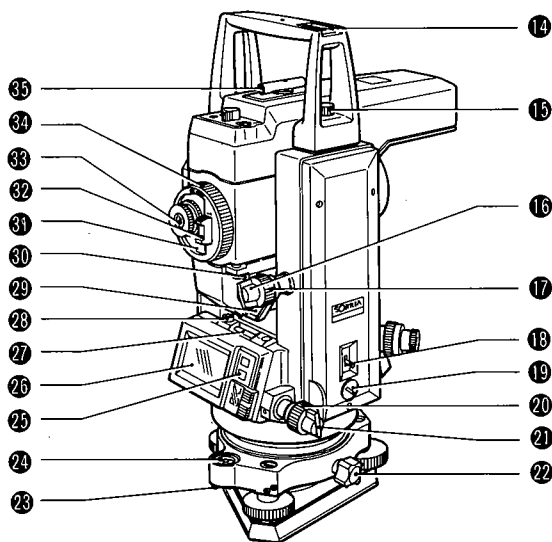
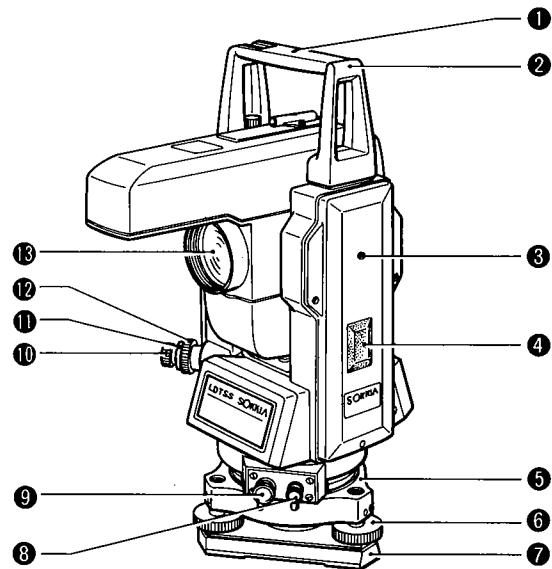

Instrument shown: LDT5S

- 1 Instrument centre mark
- 2 Handle
- 3 Instrument height mark
- 4 Internal switch cover
- 5 Tribrach
- 6 Levelling foot screw
- 7 Base plate
- 8 Data output connector
- 9 Power source connector
- 10 Optical plummet eyepiece
- 11 Optical plummet reticle adjustment cover
- 12 Optical plummet focussing ring
- 13 Objective lens
- 14 Tubular compass slot
- 15 Handle securing screw
- 16 Vertical clamp
- 17 Vertical fine motion screw
- 18 Power switch
- 19 Breaker cover

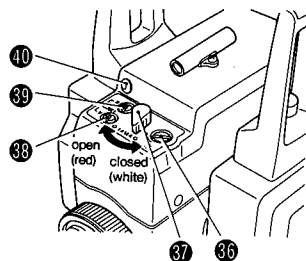

- 36 Reticle illumination adjuster
- 37 Laser beam shutter
- 38 Laser beam vertical adjusting screw
- 39 Laser beam horizontal adjusting screw
- 40 Laser indicator lamp (green)

- 20 Horizontal fine motion screw
- 21 Horizontal clamp
- 22 Tribrach shifting clamp
- 23 Circular level adjusting screws
- 24 Circular level
- 25 Keyboard
- 26 Display
- 27 Plate level
- 28 Plate level adjusting screw
- 29 Telescope level reflector
- 30 Telescope level
- 31 Telescope reticle adjustment cover
- 32 Reticle cover locking knob
- 33 Telescope eyepiece
- 34 Telescope focussing ring
- 35 Peep sight

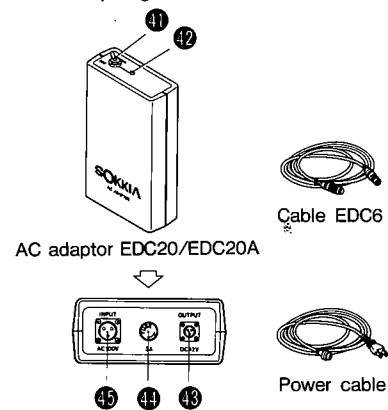

- 41 Power switch
- 42 Pilot lamp
- 43 Connector for EDC6
- 44 Fuse
- 45 Connector for power cable

3. LASER WARNING LABELS

The LDT5 is classified as a Class II laser product according to United States Government Code of Federal Regulations CFR21. This means that caution should be observed when using this instrument.

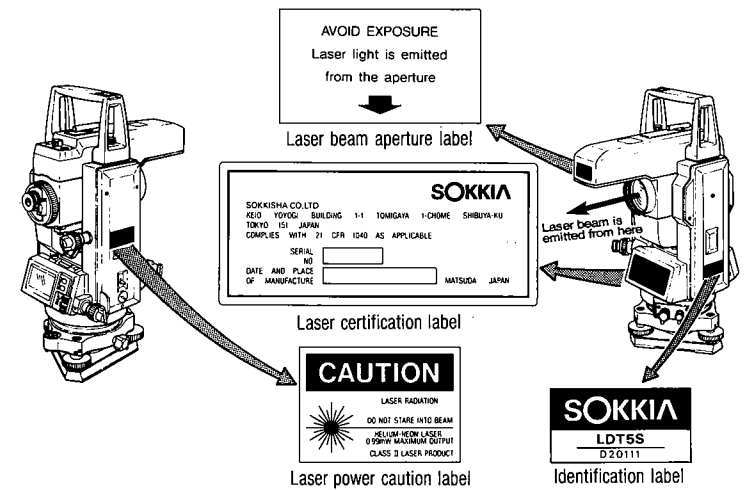

4. QUICK GUIDE TO LDT5 OPERATION

Please ensure that you are fully familiar with the instrument and manual before using this quick guide.

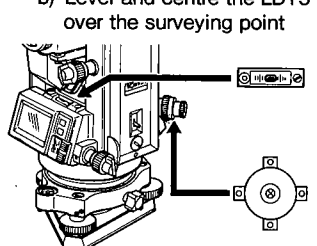
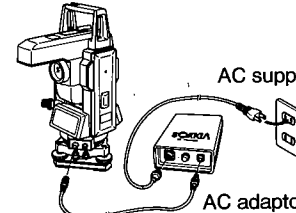
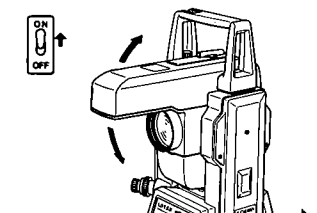
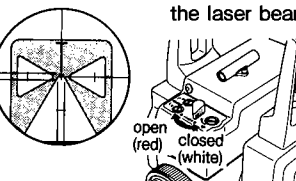
<p>1. a) Mount the LDT5 on the tripod b) Level and centre the LDT5 over the surveying point</p>  <p>Centring and Levelling; page 6</p>	<p>2. a) Connect the cables to the power supply</p>  <p>Cable connecting procedure; page 10</p>
<p>3. a) Turn the switches on b) Index the vertical circle (Rotate the telescope)</p>  <p>Power on; page 10 Vertical circle indexing; page 12</p>	<p>4. a) Sight and focus on the target b) Turn the laser beam shutter to the red mark to output the laser beam</p>  <p>Sighting procedure; page 8 Laser beam output; page 13</p>

Key operations:

- To set horizontal angle to zero, press **0 SET**.
- To hold the displayed horizontal angle value, press **▶◀**.
- *To select horizontal angle right or left, press **◀▶**.
- *To change vertical angle to % vertical angle mode, press **↕**.
- To illuminate display and reticle of telescope, press **☉**.

* Key function depends on the internal switch setting.

5. DISPLAY SYMBOLS/KEY FUNCTIONS

Display symbols

V = Vertical angle
H = Horizontal angle

Angle value or error code

Display symbols:

- (: Vertical angle (0° horizontal ± 90°)
- % : % vertical angle
- ☉ : Battery low warning
- GRD : gon angle units
- ◀▶ : Horizontal angle right
- ▶◀ : Horizontal angle left
- ◼ : Horizontal angle hold

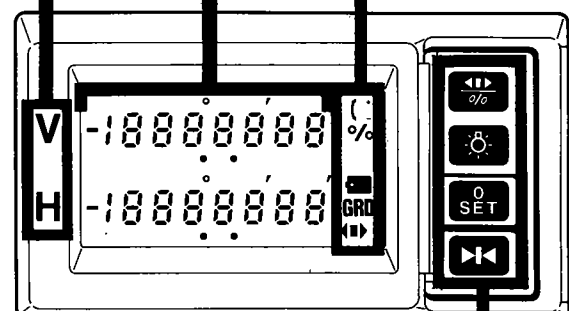

Key functions

- ◀▶ * Select horizontal angle direction to right or left
- ↕ * Select/release % vertical angle mode
- ☉ : Illuminate display and reticle of telescope
- 0 SET : Set horizontal angle to zero
- ◀▶ : Hold/release horizontal angle

Note: The **0 SET** and **◀▶** keys can be protected from accidental resetting with the sliding keyboard cover.

* The function of **◀▶** is determined by the internal switch 1 setting. (See page 28.)

6. SETTING UP THE INSTRUMENT

6.1 Centring and levelling

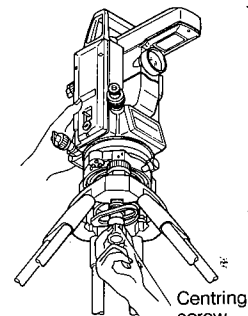

- 1) Set up the tripod so that:
 - a) The tripod head is approximately level, at a convenient height for the operator, and over the surveying point.
 - b) The tripod shoes are firmly fixed in the ground.
- 2) Place the LDT5 on the tripod head. Support it with one hand and insert and tighten the centring screw with the other. This screw should be tight whenever the theodolite is on the tripod.

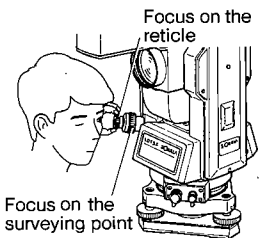

- 3) Focus on the surveying point:
 - a) Turn the optical plummet eyepiece ⑩ to focus on the reticle.
 - b) Turn the optical plummet focussing ring ⑪ to focus on the surveying point.

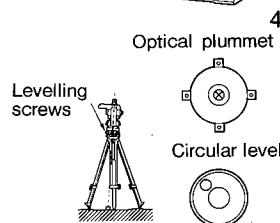

- 4) Adjust the levelling foot screws ⑥ to centre the surveying point in the optical plummet reticle circles. Observe the off-centre direction of the circular level ⑭ bubble.

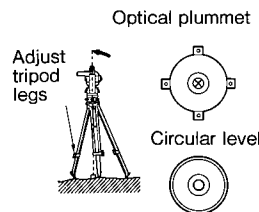

- 5) Shorten the tripod leg nearest the bubble direction or extend the leg farthest from this direction. Generally, two tripod legs must be adjusted to centre the circular level bubble.

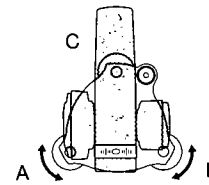

- 6) Using the horizontal clamp ②, turn the upper part of the instrument until the plate level ⑦ is parallel to a line between levelling screws A and B.

Centre the plate level bubble using levelling screws A and B.

Note: The bubble moves towards a clockwise-rotated foot screw.

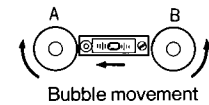

- 7) Turn the upper part through 90°. The plate level is now perpendicular to a line between levelling screws A and B. Centre the plate level bubble using levelling screw C.

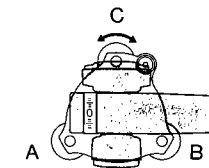

- 8) Turn the upper part a further 90° and check the bubble position.

If the bubble is off-centre, either perform the plate level adjustment described on page 20 or carefully adjust levelling screws A and B in equal and opposite directions to remove half of the bubble displacement. Again turn the upper part a further 90° and use levelling screw C to remove half of the displacement in this direction.

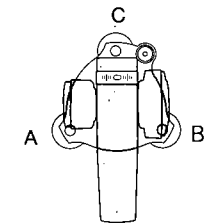

The bubble should now remain in the same position for any position of the upper part of the instrument.

(If it does not, repeat the levelling procedure.)

The following steps are different for the LDT5 and LDT5S:

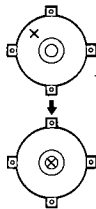

LDT5:

- 9) Check the position of the surveying point in the optical plummet eyepiece. If necessary, loosen the centring screw slightly and carefully slide the instrument over the tripod head until the surveying point is exactly centred in the reticle.
Re-tighten the centring screw.

- 10) Repeat procedures 6)~9) until the instrument is correctly levelled and centred over the surveying point.

LDT5S:

- 9) Turn the tribrach shifting clamp ⑫ anti-clockwise.
Adjust the instrument position on the tribrach to centre the surveying point in the reticle. Tighten the shifting clamp to fix the instrument in the centred position.

Note: The LDT5S shifting tribrach can be adjusted up to ± 8 mm without moving the base plate.

6.2 Focussing and target sighting

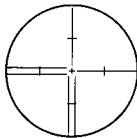

- 1) Look through the telescope at a bright, featureless background and turn the eyepiece ⑬ clockwise, then counter-clockwise until just before the reticle (cross lines) image goes out of focus. Using this procedure, frequent reticle re-focussing is not necessary, since your eye is focussed at infinity.

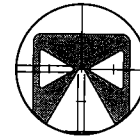

- 2) Loosen the vertical and horizontal clamps ⑮, ⑯ and use the peep sight ⑭ to bring the target into the field of view.
Re-tighten both clamps.
- 3) Turn the focussing ring ⑰ to focus on the target. Use the vertical and horizontal fine motion screws ⑱, ⑲ to sight the target precisely. The last adjustment of each fine motion screw should be in a clockwise direction.

IMPORTANT:

4) While looking at the target, move your head slightly up and down and to the right and left. If the reticle line appears to move with respect to the target, parallax is present, which will introduce reading errors. To eliminate this parallax effect, re-focus with the focussing ring. (If parallax is still present, check the reticle focussing in 1).

7. CONNECTING THE POWER SUPPLY

Before connecting the cables to the power supply, ensure that the LDT5 and EDC20/EDC20A power switches ⑬, ⑭ are both off.

<Connecting procedure>

- 1) Connect the power cable to the AC adaptor EDC20/EDC20A, and connect the power plug to the power source.
 - EDC20 Input voltage: AC 92 to 132V, 50/60Hz
Output voltage: DC 12V
 - EDC20A Input voltage: AC 180 to 260V, 50/60Hz
Output voltage: DC 12V
- 2) Connect the white plug of the EDC6 cable to the EDC20/EDC20A, and connect the black plug of the EDC6 to the LDT5 power source connector ⑬.
- 3) Mount the EDC20/EDC20A on the tripod.
 - When using the optional battery BDC7, see page 31.

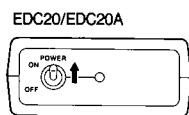
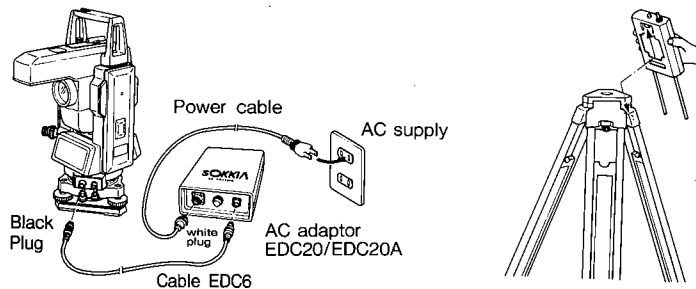

<Power on>

- 1) Turn the EDC20/EDC20A power switch ⑭ on. Make sure that the pilot lamp (green) is lit.
- 2) Ensure that the LDT5 beam shutter ⑮ is closed (set to the white spot position), and then turn the LDT5 power switch ⑬ on.

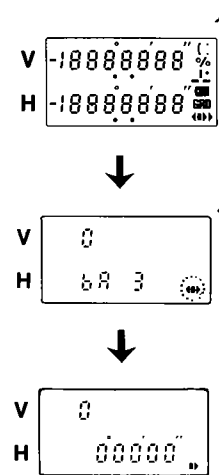
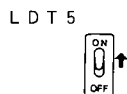

The audio tone sounds and all the display symbols are shown on the display while the instrument performs self-diagnostic checks.

- 3) When the instrument has successfully completed the checks, "bA3" (battery level) is displayed for three seconds. ("bA3" shows that the LDT5 is fully powered up.)
- 4) The display of "0" in the V display indicates that the instrument is ready for vertical circle indexing.

• If the EDC20/EDC20A pilot lamp does not light, or if the display symbols do not appear on the LDT5 display, check as follows:

- Check if the cables are firmly connected.
If not, connect the cables in the correct way.
- Check if the fuse of the EDC20/EDC20A is blown.
If so, replace the fuse (3A) with a new one.
- Check if the breaker of the LDT5 has switched off.

Remove the breaker cover ⑯ and ensure that the breaker switch is set so that the red mark can be seen.

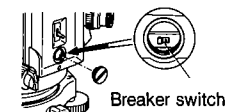

- Check if any cables are broken.
If so, replace the broken cable.

<Power off>

- 1) Turn the LDT5 power switch off.
- 2) Turn the EDC20/EDC20A power switch off.
- 3) Remove the power plug from the AC source.
- 4) Remove the cables from the LDT5 and EDC20/EDC20A connectors.

8. INDEXING THE VERTICAL CIRCLE

Turn the LDT5 power switch 18 on.

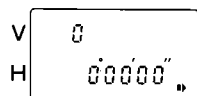

... Waiting for vertical circle indexing (If V: is displayed, the instrument parameters have been set to manual circle indexing. See note below.)

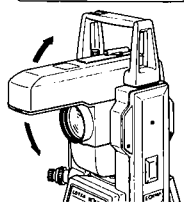

1) Vertical circle indexing
Loosen the vertical clamp 16, and rotate the telescope.
(Indexing occurs when the objective lens crosses the horizontal plane in face left.)

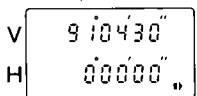

The audio tone sounds and the vertical angle is displayed.

Angle measurement can now begin.

Note: Each time the instrument is switched on, the vertical index must be redetermined.

Instrument parameters: See page 28.

Internal switch 4 can be used to change the vertical circle indexing. Options are indexing by transiting the telescope (as above) or manual indexing by face left, face right sightings (see page 29).

9. LASER BEAM OUTPUT AND ANGLE MEASUREMENT

The LDT5 is equipped with a shutter for the laser beam which switches off the beam when it is not in use. THIS SHUTTER SHOULD BE CLOSED (SET TO THE WHITE SPOT POSITION) WHEN THE LASER BEAM IS NOT REQUIRED. After switching on and sighting and focussing on the target, open the shutter (turn it to the RED spot position) to output the laser beam. (WHEN THE SHUTTER IS TURNED TO THE RED SPOT POSITION, THE LASER INDICATOR LAMP 40 LIGHTS AND THE LASER BEAM IS OUTPUT.)

LASER BEAM OUTPUT

In the LDT5, the focus of the laser beam coincides with the focus of the telescope, so that the beam will be focussed to its minimum diameter when the telescope is focussed on a target, and there will be no parallax between the telescope sighting axis and the laser beam.

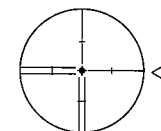
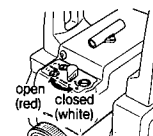

ADJUSTING THE LASER BEAM

When the laser spot does not coincide with the reticle centre, adjust as follows by turning the laser beam adjusting screws 38, 39.

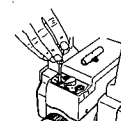

- Vertical position adjustment:
By turning the adjusting screw V clockwise(anticlockwise), the laser spot moves up(down).

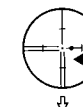
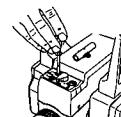

- Horizontal position adjustment:
By turning the adjusting screw H clockwise(anticlockwise), the laser spot moves left(right).



Instrument internal parameter switches: See page 28.

- Internal switches 2 and 3 can be used to select the displayed vertical angle mode. Options are:

Zenith 0°

SW2: OFF

SW3: OFF

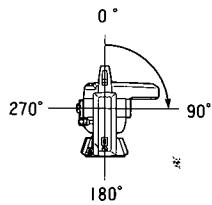

Horizontal 0° F.L.

SW2: ON

SW3: OFF

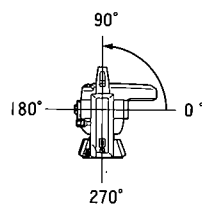

Horizontal 0° ± 90°

SW3: ON

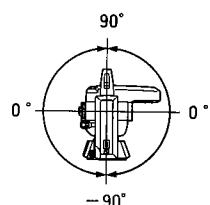

Drawings show LDT5 in the face left position.

- The range of the vertical angle display is F.L.161° ~ Zenith 0° ~ F.R. 259°, when the handle ② is removed. (To remove the handle: see page 30)
- The internal rotary switch can be used to select the V and H angle units. Options are: Degrees, gon, Mil.

9.1 Reading the horizontal and vertical angles

V	87°03'20"	Vertical angle	87°03'20"
H	60°40'40"	Horizontal angle	60°40'40"

9.2 Set horizontal angle to zero

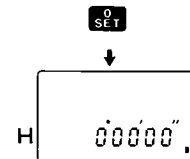

Slide up the keyboard cover and press **0 SET** to set the horizontal angle to zero.

9.3 Lay out a required horizontal angle, e.g. 90°00'00"

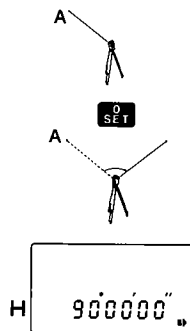

Sight the reference target A.

Press **0 SET** to set the horizontal angle display to zero, as above.

Loosen the horizontal clamp and turn the upper part until the required horizontal angle (90°00'00") is displayed.

The telescope is now sighted in the required direction.

9.4. Measure the horizontal angle between two targets

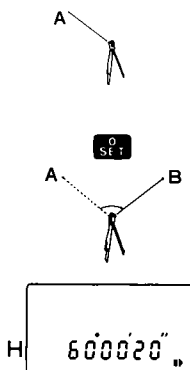

Sight the first target A.

Press **0 SET** to set the horizontal angle display to zero, as in 9.2 above.

Use the horizontal and vertical clamps and fine motion screws to sight target B.

The displayed horizontal angle is the angle between targets A and B.

9.5 Hold the horizontal angle value

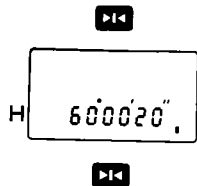

Slide up the keyboard cover and press **▶◀** to hold the displayed horizontal angle value. (The hold symbol **■** is displayed.) To release the horizontal angle hold, press **▶◀** again.

9.6 Set the horizontal circle to a required value

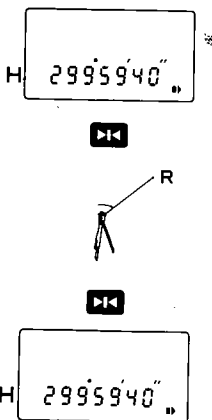

e.g. Set 299°59'40" to reference target R.

Use the horizontal clamp and fine motion screw to turn the upper part until an angle of 299°59'40" is shown on the display.

Press **▶◀** to hold the horizontal angle display, as described above.

Use the horizontal and vertical clamps and fine motion screws to turn the theodolite to sight on reference target R.

Press **▶◀** to release the display hold.

Reference target R has now been set to 299°59'40".

9.7 Select the horizontal angle right or left

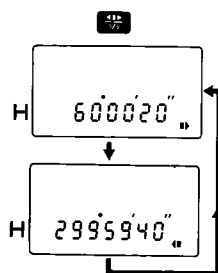

When the internal parameter switch 1 (See page 28) is set to OFF, the **◀▶** key can be used to select the required horizontal angle display:

(display symbol **▶** : horizontal angle right)

(display symbol **◀** : horizontal angle left)

Note: When internal parameter switch 1 is OFF (L/R), the % vertical angle can not be displayed.

9.8 % vertical angle

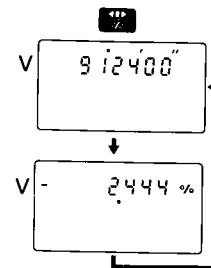

When the internal parameter switch 1 (See page 28) is set to ON, the **◻** key can be used to enter/exit from the % vertical angle display.

Press **◻** to change to the % vertical angle display.

The % symbol is displayed.

Note: When internal parameter switch 1 is ON (%), horizontal angle left can not be displayed.

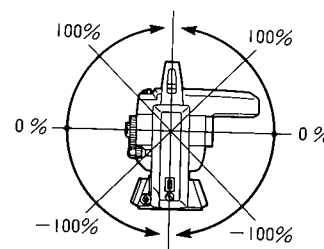

Maximum displayed value

Face left: -290% ~ +999.909%

(-71° ~ +84°17'20")

Face right: -19% ~ +999.909%

(-11° ~ +84°17'20")

% vertical angle = 100 × tan θ

where θ = 0° ± 90°

Press **◻** again to return to the vertical angle display.

9.9 Display and reticle illumination

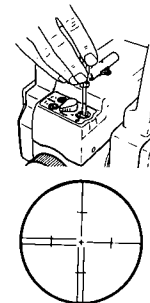

Press **⊙** to illuminate the display and reticle of the LDT5.

Press **⊙** again to switch the illumination off.

To adjust the brightness of the reticle illumination, turn the illumination adjuster **⊙** on the theodolite telescope.

10. ERROR CODES

If there is any fault in the theodolite function, the error codes shown in the following table will be displayed.

Display	Meaning	Action
ε 100	* Error when measuring a horizontal angle	Reset the horizontal angle to zero.
ε 101	* Error when measuring a vertical angle	Index the vertical circle again.

* If the upper part or the telescope of the LDT5 is rotated faster than four revolutions per second, the error indication ε 100 or ε 101 is displayed.

When using optional battery BDC7, if  is displayed, charge the battery as described on page 32.

If the error indication ε appears with any number other than the ones above, please contact your Sokkisha agent.

11. OPTICAL DISTANCE MEASUREMENT: STADIA SURVEY

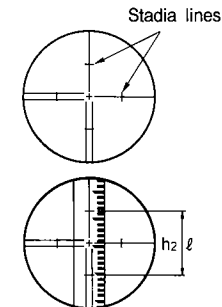

The telescope reticle is provided with stadia lines (two vertical and two horizontal) which can be used to measure the target distance and height difference as follows.

Stadia line separation = 1/100 of the focal distance.

When the telescope is horizontal:

Read the distance (ℓ) on the staff between the two stadia lines, and the centre line value, h_2 .

Horizontal target distance $L = 100 \times \ell$

Target height difference $\Delta h = h_1 - h_2$

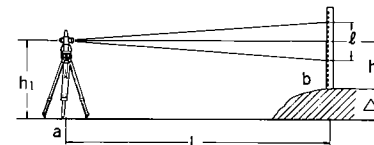

When the telescope is slanted:

Read the distance (ℓ) on the staff between the two stadia lines, the vertical angle, and the centre line value, h_2 .

Horizontal target distance $L = 100 \times \ell \times \sin^2 \theta_z$

or $100 \times \ell \times \cos^2 \theta_v$

Target height difference $\Delta h = 50 \times \ell \times \sin 2\theta_z + h_1 - h_2$

or $50 \times \ell \times \sin 2\theta_v + h_1 - h_2$

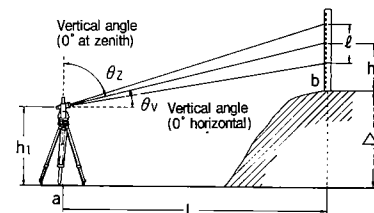

12. CHECKS AND ADJUSTMENTS

It is important that the LDT5 is periodically checked and adjusted. In addition, the instrument should be checked after transportation, long storage or when damage to the instrument is suspected to have occurred.

12.1 Plate level

The glass tube of the plate level is sensitive to temperature change or shock. Adjust as follows:

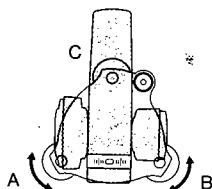

a) Turn the upper part of the instrument until the plate level is parallel to a line between levelling foot screws A and B.

Centre the plate level bubble using levelling screws A and B.

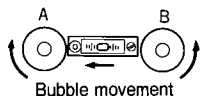

Note: The bubble moves towards a clockwise-rotated foot screw.

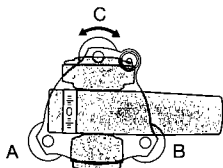

b) Loosen the horizontal clamp ④ and turn the upper part 90°. i.e. The plate level is perpendicular to a line between levelling screws A and B.

Centre the plate level bubble using levelling screw C.

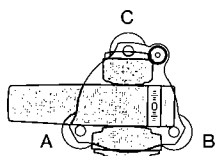

c) Turn the upper part through 180° and check the position of the plate level bubble.

If the bubble is still centred, no adjustment is necessary.

If the bubble is not still centred, adjust as follows:

① Use levelling screws

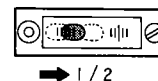

① Correct half of the bubble displacement using levelling screw C.

② Use adjusting pin

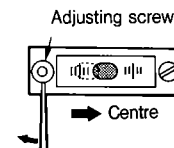

② Correct the remaining half displacement with the adjusting pin.

Note: The bubble moves away from a clockwise rotation of the adjusting screw.

③ Repeat the procedures from a) until the bubble remains centred for any position of the upper part.

12.2 Circular level

a) Perform the plate level adjustment as in 12.1, or carefully level the instrument using the plate level.

b) Check the position of the circular level bubble.

If the bubble is off-centre, adjust as follows:

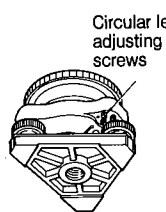

- ① Note the off-centre direction of the bubble.
- ② Loosen the adjusting screw farthest from this direction to centre the bubble.
- ③ Adjust all three adjusting screws until the tension of each screw tightening is the same, and the bubble is centred.

WARNING: Over-tightening the adjusting screws may damage the circular level.

Unequal tightening of the screws may mean that the bubble will go out of adjustment.

12.3 Telescope level

This adjustment is required if the telescope level is not parallel to the sighting line.

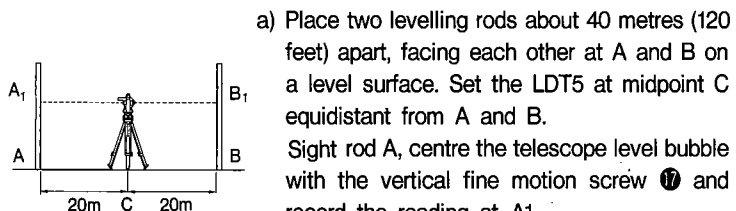

- a) Place two levelling rods about 40 metres (120 feet) apart, facing each other at A and B on a level surface. Set the LDT5 at midpoint C equidistant from A and B. Sight rod A, centre the telescope level bubble with the vertical fine motion screw and record the reading at A1. Repeat on rod B and record the reading at B1.

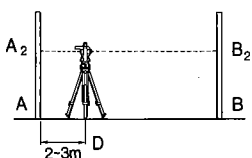

- b) Move the instrument to point D, 2 to 3 metres from rod A. Repeat the procedure described in part a) and record the readings at A2 and B2.

If either of the readings

$$(A1 - B1) = (A2 - B2)$$

$$\text{or } (A1 - A2) = (B1 - B2)$$

then the telescope level is in adjustment. if they are not, proceed to calculate the following:

$$\text{Either } A2 - (A1 - B1) = B3$$

$$\text{or } B1 - (A1 - A2) = B3$$

B3 = Target setting on rod B on which horizontal reticle line should be aligned.

- c) To adjust the LDT5, set the horizontal reticle line on B3 using the vertical fine motion screw. Be sure the vertical clamp is tight. Re-centre the telescope level bubble by moving the telescope level adjusting nuts with the adjusting pin provided. Repeat parts a) and b) and perform additional adjustment if necessary.

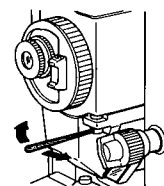

NOTE : To centre the bubble, first very slightly loosen the top (bottom) adjusting nut, then tighten the bottom (top) adjusting nut by this same amount.

12.4 Reticle

12.4.1 Perpendicularity of the reticle to the horizontal axis

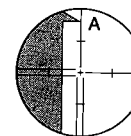

- a) Carefully level the LDT5. Select and sight a clear target on the upper part A of the reticle line.

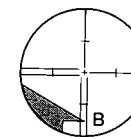

- b) Turn the telescope vertical fine motion screw until the target is on the lower part of the reticle B. Check that the target is still positioned centrally within the vertical lines.

If the target is off-centre, the following adjustment should be performed:

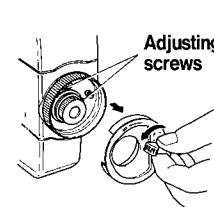

- ① Remove the telescope reticle adjustment cover after rotating the reticle cover locking knob anticlockwise through 90°.

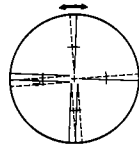
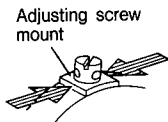

- ② Very slightly loosen one vertical and one horizontal adjusting screw by a certain amount.
- ③ Place a small piece of plastic or wood against one side of the top adjusting screw mount as a buffer.
- ④ Look through the eyepiece and gently tap the piece of plastic or wood to rotate the reticle slightly.
- ⑤ Re-tighten the two adjusting screws (loosened in ②) by the same amount.

WARNING: Over-tightening the adjusting screws may damage the reticle.

Unequal tightening of the adjusting screws may mean that the reticle will go out of adjustment.

- ⑥ Check the reticle perpendicularity again using procedures a) and b) above and repeat the adjustment if necessary. Replace the reticle adjustment cover.
- ⑦ After this adjustment, the vertical and horizontal reticle line positions should be checked as follows:

12.4.2 Vertical and horizontal reticle line positions

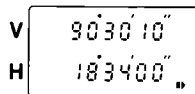
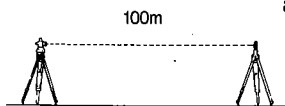

- a) Set up a clear target about 100 metres (300 feet) from the LDT5. Remove the handle ② (see page 30), carefully level the LDT5, switch on and index the vertical circle.
- b) Sight the target on face left and read the horizontal and vertical angles.

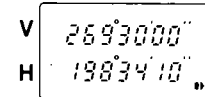

$$\text{e.g. } H = 198^{\circ}34'10'' - 18^{\circ}34'00'' = 180^{\circ}00'10''$$

$$\text{e.g. } V = 90^{\circ}30'10'' + 269^{\circ}30'00'' = 360^{\circ}00'10''$$

- c) Now sight the target on face right and read the horizontal and vertical angles.
- d) Subtract the horizontal face left angle from the horizontal face right angle. The difference should be within $180^{\circ} \pm 40''$.
- e) Add the vertical face left angle and the vertical face right angle. The sum should be within $360^{\circ} \pm 40''$. If either of the values are $40''$ or greater, repeat the above procedures.

If the difference is consistently $40''$ or greater, the theodolite reticle should be adjusted using the following procedures:

Note: Ensure that the vertical and horizontal clamps are fully tightened.

Example when:
Horizontal F.L./F.R. = $18^{\circ}34'00''/198^{\circ}34'40''$
i.e. error = $+40''$

Vertical F.L./F.R. = $90^{\circ}30'10''/269^{\circ}30'30''$
i.e. error = $+40''$

$$\text{Mean } H = \frac{18^{\circ}34'00'' + 198^{\circ}34'40''}{2} + 90'' = 198^{\circ}34'20''$$

$$\text{Mean } V = \frac{269^{\circ}30'30'' - 90^{\circ}30'10''}{2} + 180'' = 269^{\circ}30'10''$$

- ① Calculate the mean face right horizontal and vertical angles, i.e.

$$\text{horizontal} = \frac{(F.L. + F.R.)}{2} + 90''$$

$$\text{vertical} = \frac{(F.R. - F.L.)}{2} + 180''$$

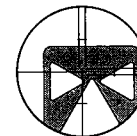
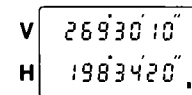

- ② While still sighting the target on face right, use the horizontal and vertical fine motion screws to adjust the displayed horizontal and vertical angles to the above values.
- ③ Look through the telescope. The reticle is now slightly shifted from the target.

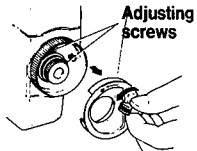

Vertical reticle line

Example: To move the reticle to the right (left)

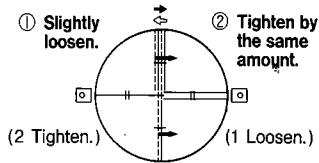

Horizontal reticle line

Example: To move the reticle down (up)

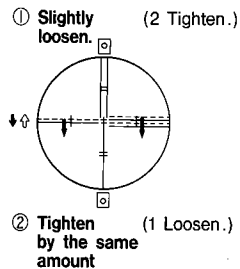

WARNING:

Over-tightening the adjusting screws may damage the reticle. Unequal tightening of the adjusting screws may mean that the reticle will go out of adjustment.

④ Remove the telescope reticle adjustment cover ① after rotating the reticle cover locking knob ② anticlockwise through 90°.

⑤ To move the vertical reticle line towards the target centre, use the adjusting pin to adjust the left and right adjusting screws as follows:

To move the reticle to the right (left), first very slightly loosen the left (right) adjusting screw, then tighten the right (left) adjusting screw by this same amount.

Check the reticle position and repeat the procedure until the reticle comes close to the target centre.

⑥ To move the horizontal reticle line towards the target centre, adjust the top and bottom adjusting screws as follows:

To move the reticle down (up), first very slightly loosen the top (bottom) adjusting screw, then tighten the bottom (top) adjusting screw by this same amount. Check the reticle position and repeat the procedure until the reticle comes close to the target centre.

⑦ Replace the reticle adjustment cover.

⑧ After adjusting the reticle position, it will be necessary to re-adjust the laser beam to the new reticle centre. For procedure, see page 13.

12.5 Optical plummet

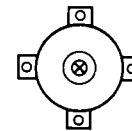

- a) Carefully level the LDT5 and exactly centre a surveying point in the reticle of the optical plummet.
- b) Turn the upper part 180° and check the position of the surveying point in the reticle.

If the surveying point is not still centred in the optical plummet, adjust as follows:

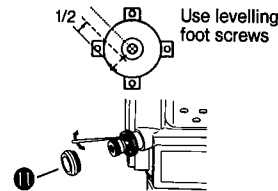

① Remove half of the displacement using the levelling foot screws.

② Unscrew the optical plummet reticle cover ①.

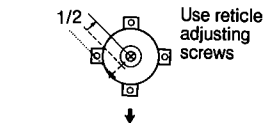

③ Now adjust the four optical plummet reticle adjusting screws with the adjusting pin to centre the reticle exactly on the surveying point.

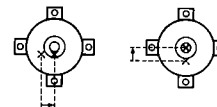

For procedure, refer to "vertical and horizontal reticle adjustment" parts ⑤ and ⑥ on the previous page.

WARNING: Over-tightening the adjusting screws may damage the reticle.

Unequal tightening of the adjusting screws may mean that the reticle will go out of adjustment.

④ Check the adjustment by rotating the upper part. The surveying point should remain centred in the reticle. If necessary, repeat the adjustment.



13. INSTRUMENT INTERNAL PARAMETER SWITCHES

Note: Before changing these switch settings, turn the LDT5 power off.

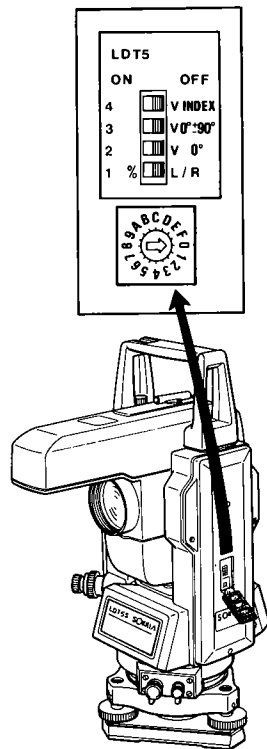

Open the internal switch cover ①.

SLIDE SWITCH	FUNCTION
1 * OFF ON	Display horizontal right / left angle using the key Display vertical / % vertical angle using the key
2 * OFF ON	Vertical angle (0° at zenith) Vertical angle (0° horizontal on face left)
3 * OFF ON	Switch has no function Vertical angle (0° horizontal ±90°) (over-rides switch 2 setting)
4 * OFF ON	Vertical circle indexing by rotating the telescope Vertical circle indexing by face left, face right observations

Rotary switch	V and H angle units
* 0	Degrees 0° ~ 359°59'55"
1	gon 0 gon ~ 399.999 gon
2	Mil 0 Mil ~ 6399.98 Mil
3 ~ F	Do not set during use. (These positions are for service)

* Switch position when instrument left the factory.

APPENDICES

Appendix A. Indexing vertical circle by face left, face right readings.

Like all theodolites, the LDT5 will have a vertical index error. The vertical index can be determined, and the index error removed, by the following procedure:

- 1) Ensure that the LDT5 power switch is off. Change the internal switch 4 to ON (see previous page); i.e. Vertical circle indexing by face left, face right readings.

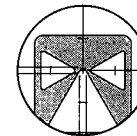
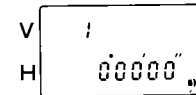

Face left

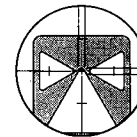
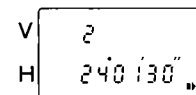

Face right

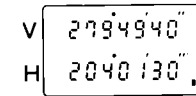

- 2) Remove the handle ② (see page 30), carefully level the LDT5 and switch the instrument on. The prompt **:** is displayed in the V display.
- 3) In the face left position, accurately sight a clear target at a horizontal distance of about 30 metres (100 feet). Press . The prompt **2** is displayed in the V display.

- 4) On face right, accurately sight the same target.

Press again.

When the vertical circle has been indexed, the vertical angle is displayed.

Note: The vertical circle must be re-indexed each time the LDT5 is switched on.

Ensure that the instrument is switched off when moving it to a new location.

Appendix B. Standard accessories

1) Plumb bob

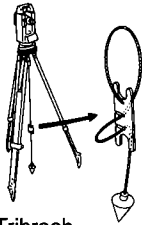

If the weather is calm, or for initial tripod centering, the plumb bob can be used for centering. To use, unwind the plumb bob cord and attach it to the hook inside the centering screw. Use the cord grip piece to adjust the cord length.

2) Tribrach

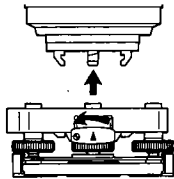

The LDT5 instrument can be removed from the tribrach by rotating the tribrach clamp anticlockwise and carefully lifting the instrument up.

(The LDT5S has a shifting tribrach for quick centering, and the instrument can not be removed.)

3) Handle

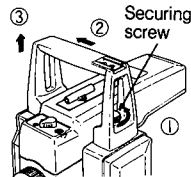

The carrying handle can be removed from the instrument by unscrewing the handle securing screw and sliding the handle to the side. When replacing the handle, ensure that the securing screw is fully tightened.

4) Tubular compass CP7 (accuracy $\pm 1^\circ$)

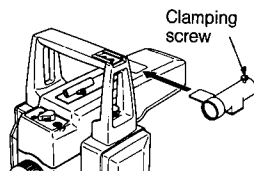

To mount the CP7, slide it into the tubular compass slot on the carrying handle. To use, loosen the clamping screw to free the compass needle. Turn the instrument in the face left position until the compass needle bisects the index lines. The telescope is now aligned with magnetic north. After use, tighten the clamp to fix the compass needle and remove it from the instrument.

Appendix C. Optional accessories

1) Battery BDC7

The rechargeable battery BDC7 is convenient for use in places where an AC supply is not available.

< Connecting procedure >

- a. Mount the battery BDC7 on the tripod.
- b. Make sure that the LDT5 power switch ⑩ is off.
- c. Connect the black plug of the EDC6 to the LDT5 power source connector ⑨.
- d. Connect the white plug of the EDC6 to the battery BDC7.

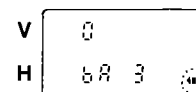
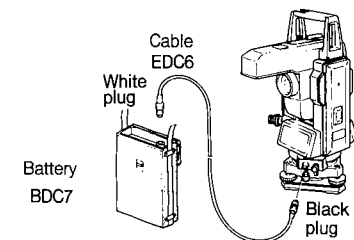
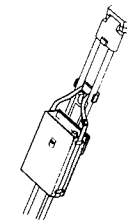

- Connect the battery and turn the LDT5 power switch on. When the instrument has completed its self-checks, the remaining battery power is displayed as a numeric code (3~0) for three seconds:

{ When "bA 3" (full power) is displayed and the laser beam is emitted, the working duration is 3.5 hours at 25°C.



- When the symbol is displayed, the battery should be recharged. Turn the power switch off and disconnect the cable, then charge the battery with the charger CDC7.

<Precautions for BDC7 battery charging>

To charge the battery, use only the recommended charger.

- Charge the battery at least once a month if it is not used for a long time.
- Battery operating life is shortened at extreme temperatures.
- Store the battery in a place where the temperature is between 0°C and 40°C.

2) Charger CDC7/CDC7A/CDC7B

CDC7 Input voltage: AC 100V, 50/60Hz

CDC7A Input voltage: AC 120V, 50/60Hz

CDC7B Input voltage: AC 220V, 50/60Hz

< Connecting procedure >

- Connect the power plug to the power source.
- Connect the CDC7 to the battery BDC7.
- Make sure the pilot lamp is on.
- About 15 hours are required for charging.
- When charging is over, remove the charger from the battery and the power source.

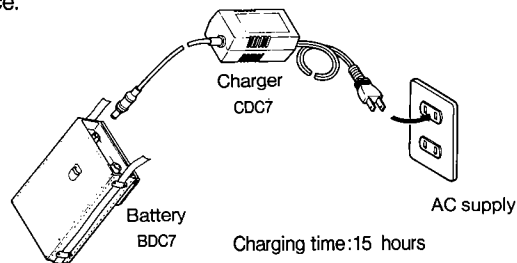

< Precautions >

- Charge the battery at a temperature between 10°C and 40°C. Do not charge the battery for longer than the specified time.
- The battery charger normally becomes warm while charging.
- Do not use the charger to charge more than three batteries successively.

3) Laser adaptor LCA2

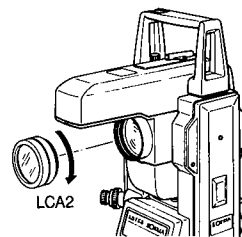

The laser adaptor LCA2 is mounted on the objective lens.

By means of the cross-hairs, the LCA2 enables the observer to more accurately centre the laser beam on the target. Depending on the target, the cross-hairs may be rotated as desired.

4) Diagonal eyepiece DE17

Solar filter MA04A

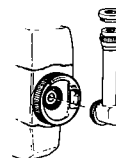

The diagonal eyepiece is convenient for near-vertical observations and in places where space around the instrument is limited.

Remove the telescope eyepiece by unscrewing the mounting ring, and screw in the diagonal eyepiece.

5) Solar filter EF2

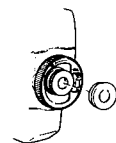

For observations to the sun, and where glare is present.

6) Target sets TG1 and TG2

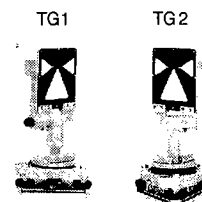

The TG1 and TG2 targets can be mounted on the standard removable tribrach. An illumination device (standard accessory) can be attached to the back of the target plate for surveying in low light conditions. The target heights are 233 mm.

7) Electronic field books SDR series

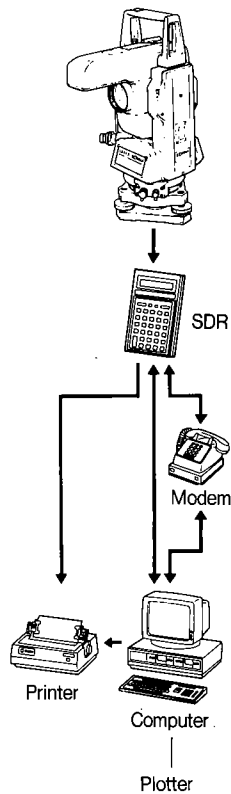

The SDR series can collect and store all angle values output from the LDT5 data output connector ③. (Distance values can be input manually if required).

The stored data can be verified and printed in the field, then transmitted by cable or modem to an IBM-compatible office data processing system for final computation, printing and plotting.

SDR features:

- Simple, powerful operation with clear menu and program display prompts.
- Wide choice of recording parameters.
- Recorded data can not be cleared from the memory until it has been transmitted or printed.
- Additional programs and data can be input to the SDR from an external computer.

SDR Series Specifications:

Power source: "AA" size batteries (×4)

Memory type: CMOS
 ROM 64K
 RAM 32, 64 or 128K

Keyboard: 33 keys

Display: LCD

Baud rate: 300, 600, 1200, 2400, 4800, 9600 bps

Operating

temperature: 0 to 50°C (32°F to 122°F)

Weight: 450 g (1 lb)

SPECIFICATIONS/STANDARD EQUIPMENT

Laser (Class II laser product)

Light source	He-Ne gas laser
Output power	Less than 1 mW
Wave length	632.8 nm
Laser beam shutter	Provided
Laser beam axis	Adjustable
Laser beam focussing	Simultaneous with telescope sighting focussing
Beam spot diameter	φ 7 mm/100m φ 13 mm/200m

Telescope

Length	160 mm
Aperture	42 mm
Magnification	30 X
Resolving power	3"
Image	Erect
Field of view	1°30' (26 m/1000 m)
Minimum focus	1.3 m (4.3 ft)
Stadia ratio	1:100
Additive constant	0
Reticle illumination	Brightness adjustable

Horizontal circle

Type	Incremental
Minimum display	5" (0.001 gon/0.02 Mil)

Vertical circle

Type	Incremental with zero index
Minimum display	5" (0.001 gon/0.02 Mil)

Display

H. Angle range	0° - 359°59'55" (0-399.999 gon/ 0-6399.98 Mil)
----------------	---

V. Angle range

	161° - Zenith 0° - 259° (178 - Zenith 0 - 288 gon/ 2862 - Zenith 0 - 4605 Mil) (-290% - 999.909% on face left)
--	---

Measuring mode

Horizontal angle

Vertical angle

Measuring time

Angle units

Sensitivity of levels

Telescope level

Plate level

Circular level

Optical plummet

Image

Magnification

Minimum focus

Data Output**Self diagnostic function****Operating temperature****Power supply****Instrument height****Size (with handle)****Weight****LDT5****LDT5S**

Right or Left, Hold

0° at zenith/

0° horizontal on face left/

0° horizontal ±90° (±100 gon/

±1600 Mil)/(° vertical angle)

Less than 0.5 second

Degree/Gon/Mil selectable

40"/2 mm

40"/2 mm

10"/2 mm

Erect

3X

0.1 m (0.3 ft)

Asynchronous serial, RS-232C
compatible

Provided

-20°C to 50°C (-4°F to 122°F)

AC 92V ~ AC132V using AC adaptor EDC

20/AC180V ~ AC260V using AC adaptor

EDC20A/Optional rechargeable battery

BDC7(DC12V, 3.5 hours use at 25°C)

236 mm

143(W) × 248(D) × 368(H) mm

(5.6 × 9.8 × 14.5inch)

6.3kg (13.9 lbs)

Removable tribrach

Shifting-style tribrach

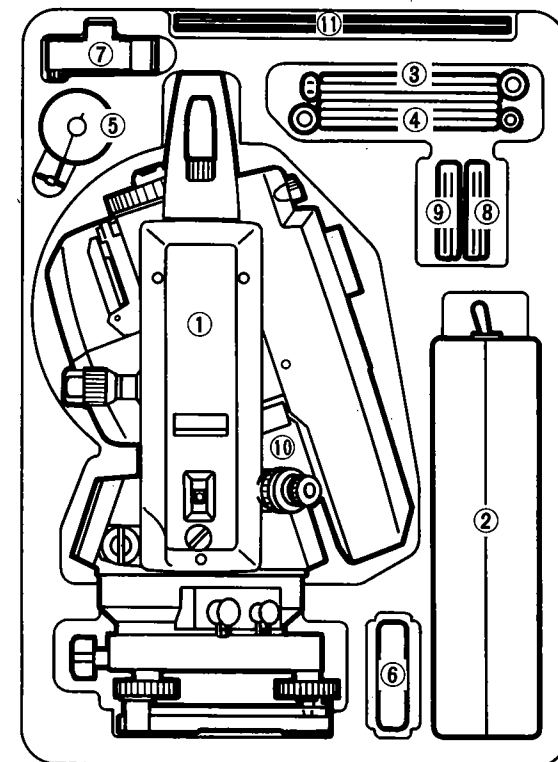
Standard Equipment

- | | | | |
|---------------------------------|---|-----------------------------|---|
| ① Main unit | 1 | ⑦ Tubular compass CP7 | 1 |
| ② AC adaptor EDC20/EDC20A | 1 | ⑧ Vinyl cover | 1 |
| ③ (w/power cable) | 1 | ⑨ Cleaning cloth | 1 |
| ④ Cable EDC6 | 1 | ⑩ Lens cap | 1 |
| ⑤ Plumb bob | 1 | ⑪ Operator's manual | 1 |
| ⑥ Tool pouch | 1 | Carrying case SC89 | 1 |
| Adjusting pins | 2 | Shoulder strap | 1 |
| Screwdriver | 1 | | |
| Brush | 1 | | |

アース線とアース棒
Grounding rod with cable



MAINTENANCE

- a) Wipe off any moisture if the instrument gets wet during operation.
- b) Always clean the instrument before returning it to its case. The lens requires special care. Dust it off with the lens brush first, to remove minute particles. Then, after providing a little condensation by breathing on the lens, wipe it with a soft, clean cloth or lens tissue. When cleaning the display, keyboard and carrying case, never use any organic solvent(eg. thinners).
- c) Store the instrument in a dry room where the temperature remains fairly constant.
- d) Check the tripod for loose fitting and loose screws.

The specifications and general appearance of the instrument may be altered at any time and may differ from those appearing in catalogues and the operator's manual.

MEMO

AC power adaptor EDC20/EDC20A/EDC25 using PRECAUTION

When using the AC power adaptor, connect the power plug to a grounded power source or use the provided converter plug with the grounding rod, be sure to ground as follows.

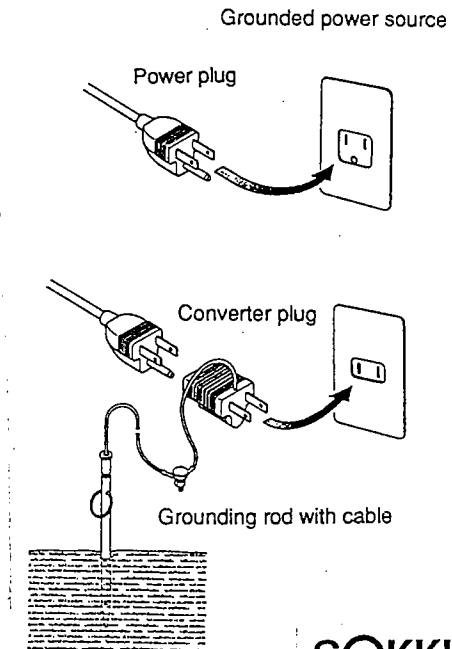

SOKKIA

MEMO

.....
.....
.....
.....
.....
.....
.....
.....
.....
.....
.....
.....
.....
.....
.....
.....
.....
.....
.....
.....
.....
.....

SOKKIA CORPORATION

9111 Barton, P.O. Box 2934, Overland Park, Kansas 66201, U.S.A.
Phone 913-492-4900 Fax. 913-492-0188

SOKKIA INC.

820 Denison Street, Unit 1, Markham, Ontario, Canada L3R 3K5
Phone 416-475-1450 Fax. 416-475-1453

SOKKIA PTY.LTD.

107 Leicester Street, Carlton, Victoria 3053, Australia
Phone 03-347-5844 Fax. 03-347-0740

SOKKIA NEW ZEALAND

20 Constellation Drive, Mairangi Bay, Auckland 10, C.P.O. Box 4464,
Auckland, New Zealand
Phone 09-479-3064 Fax. 09-479-3066

SOKKIA B.V.

Businesspark De Vaart, Damluisweg 1, 1332 EA Almere, P.O. Box 1292,
1300 BG Almere, The Netherlands
Phone: 03240-22880 Fax. 03240-26241

SOKKIA LTD.

Unit 5, Oak Court, Betts Way, Crawley, West Sussex, RH10 2GB,
United Kingdom
Phone 0293-561618 Fax. 0293-561626

SOKKIA GmbH

Emil-Hoffmann-Str. 7a, 5000 Koeln 50, Germany
Phone 2236-64058 Fax. 2236-62675

SOKKIA S.A.

12, Avenue Gabriel Peri, 78360 Montesson, France
Phone 1-30-53-09-73 Fax. 1-39-76-63-15

SOKKIA S.R.L.

Via Bologna 50, 10152 Torino, Italy
Phone 011-248-0080 Fax. 011-248-2702

SOKKIA AB

Transportgatan 5, S-422 46 Hisings Backa, Sweden
Phone 031-581550 Fax. 031-528580

SOKKIA N.V.

Sphere Businesspark, Doornveld 1-1A, B-1731 Zellik (Brussels),
Belgium
Phone 02-466-82-30 Fax. 02-466-83-00

SOKKIA KOREA CO.LTD.

Rm. 401, Kwan Seo Bldg, 561-20 Sinsa-Dong, Kangnam-ku, Seoul,
Republic of Korea
Phone 02-514-0491 Fax. 02-514-0495

SOKKIA PTE LTD.

6001 Beach Road, #21-06, Golden Mile Tower, Singapore 0719
Phone 292-5483 Fax. 293-7916