

SOKKIA

SDM3E

ELECTRONIC TACHEOMETER

OPERATION MANUAL

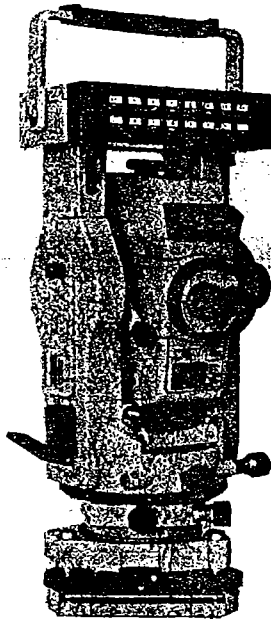

Exclusive U.S. Distributor

SOKKIA

9111 Barton, Box 2934
Overland Park, Kansas 66201
(913) 492-4990

CONTENTS

I	FEATURES	2
II	SPECIFICATIONS.....	2
	1. Distance measuring.....	2
	2. Angle measuring.....	4
III	EXPLANATION OF PARTS	5
IV	STANDARD SET.....	11
V	OPERATION	17
	1. Setting up the SDM3E	17
	(1) Setting up the tripod	17
	(2) Center the SDM3E by adjusting leg length	18
	(3) Centering with the plumb bob	20
	(4) Focusing of the telescope	20
	(5) Sighting	21
	(6) Swivel lever	22
	2. Measuring angles	23
	(1) Horizontal and vertical circle reading	23
	(2) Horizontal angle measurement	25
	(3) Zenith angle measurement	28
	(4) Vertical angle	29
	3. Distance measurement	30
	(1) Preparation	30
	(2) Measuring the slope distance.....	33
	(3) Keyboard operation.....	34
	(4) Mode of measurement	42
	(5) To recall data	59
VI	CORRECTIONS.....	60
	1. Prism constant.....	60
	2. Earth-curvature and refraction correction	60
	3. Atmospheric correction	61
VII	INTERNAL BATTERY No.6850-01.....	63
	1. Specifications	63
	2. Handling	63
	3. Precautions.....	64

VIII	BATTERY CHARGER No.6855-01 FOR THE INTERNAL BATTERY	65
1.	Specifications	65
2.	Handling	65
3.	Precautions	66
IX	OPTIONAL ACCESSORIES	67
1.	Power source system for the SDM3E	67
(1)	1 hour quick charger No.6855-02	68
(2)	1 hour car battery charger No.6855-03	69
(3)	External battery converter No.6860-01	71
(4)	AC power adaptor No.6861-01	72
(5)	Cable to cigar lighter No.6860-05	73
(6)	Cable to car battery No.6860-03	74
2.	Diagonal eyepiece	75
X	CHECKS AND ADJUSTMENTS	76
1.	Angle measuring function	76
(1)	Plate level	76
(2)	Circular level	78
(3)	Inclination of the reticle	78
(4)	Vertical reticle line	79
(5)	Horizontal reticle line	81
(6)	Coincidence of the distance measuring axis with the reticle	82
(7)	Optical plummet	83
2.	Distance measuring function	84
(1)	Self-diagnosis	84
(2)	Check flow chart	86
XI	CONFIRMATION OF DISTANCE CONSTANT	87
XII	PRECAUTIONS AND MAINTENANCE	88
1.	Precautions	88
2.	Maintenance	89
	ATMOSPHERIC CORRECTION TABLE(English)	90
	ATMOSPHERIC CORRECTION TABLE(Metric)	91

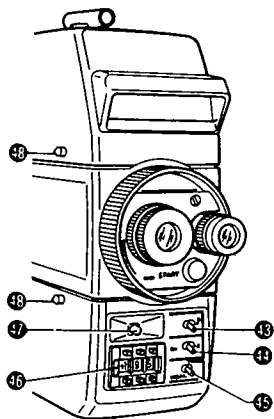
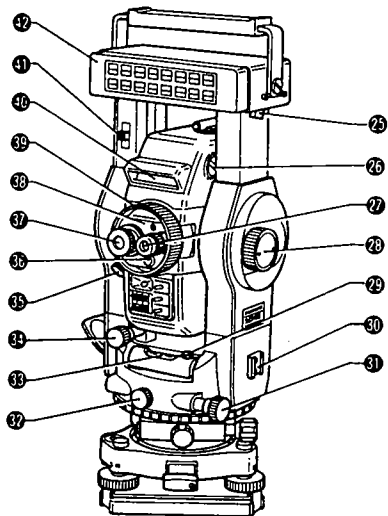
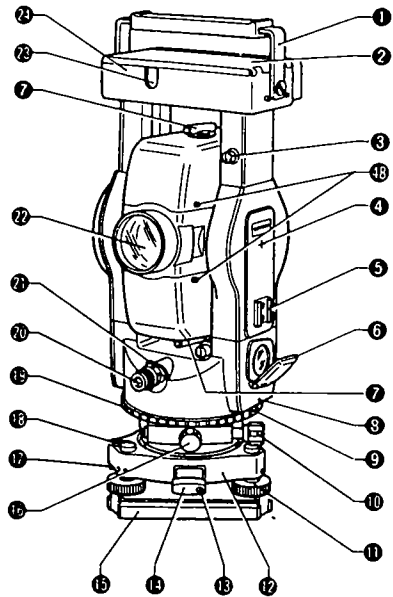

Fig. 1

I FEATURES

- Distance and angle measuring functions are synthesized in the SDM3E. Accurate and rapid operation can be executed with the SDM3E.
- Horizontal distance, height difference and coordinate are computed and displayed by keying in angle.
- Successive and tracking measurement as well as stake-out can be selected.
- The telescope can be plunged to either direction, enabling the user to observe both faces, easily.
- Adjustment of light intensity is not necessary.
- Incoming reflection from prism(s) is confirmed by light value lamp or buzzing sound.
- All the necessary information is displayed.
- Function to output the measured data is provided.
- Corrections for earth-curvature and refraction are carried out automatically.
- The SDM3E's power source is cut off two minutes after its last operation. This saves battery capacity.
- A convenient handle is provided for easy transportation.

II SPECIFICATIONS

1. Distance measuring

Range:	1-prism 35 to 3,900ft (10 to 1,200m) 3-prism 35 to 5,900ft (10 to 1,800m) (under good atmospheric conditions)
Standard deviation:	$\pm (5\text{mm} + 5\text{ppm} \cdot D)$
Display:	LED 8-digit
	Maximum slope distance 6.561.66ft (1,999.999m)
Minimum count:	Successive 0.01ft (1mm) Tracking 0.1ft (10mm)

Measurement time:

	Mode	
	Succesive	Tracking
Slope distance		4s + every 0.3s
Horizontal distance		
Height difference	4s	4s + every 0.4s
X coordinate		
Y coordinate		4s + every 0.5s

Atmospheric correction: - 99 to +199ppm (1ppm step)
Reflecting prism constant: 0 to -9cm (1cm step)
Audio target acquisition: Continuous sound; measurement OK
Intermittent sound; to confirm input
and display measurement
Signal source: LED
Output of data: RS-232-C
Light intensity control: Automatic
Self-diagnostic function: Provided
Battery check: Provided
Power saving cut off: 2 minutes after operation
Earth-curvature and
refraction correction: Provided
Temperature: -4 to +122°F (-20 to +50°C)
Power source: NiCd battery, 6V, detachable
Working duration: 1 hour at 77°F (25°C)
Charging time: 12 hours, standard charger
No. 6855-01
(1 hour, optional charger No.6855-02)

2. Angle measuring

Telescope:

Length	6.7 inches (170mm)
Aperture	1.8 inches (45mm)
Magnification	X 25
Resolving power	3.5 "
Image	Erect
Field of view (1,000 ft)	1° 30 '(26 ft)
Minimum focusing distance	4.3 ft (1.3m)

Horizontal circle:

Diameter	3.15 inches (80mm)
Digital reading	10 "

Vertical circle:

Diameter	2.75 inches (70mm)
Digital reading	10 "

Compensator, zenith angle:

Accuracy	± 0.5 "
Range of compensation	± 5 '

Sensitivity of levels:

Plate level	30 "/2mm
Circular level	10 "/2mm

Optical plummet:

Erect image, X2, more than 1.5 ft

Size:

6.5(W)X6.7(D)X15.2(H)
inches (166 X 170 X 385 mm)

Weight:

16.8 lbs (7.6 kg), w/internal battery



III EXPLANATION OF PARTS

Refer to Fig. 1, page 1.

- ① **Handle**
- ② **Battery case cover**
- ③ **Connector**
Used for data output.
- ④ **Instrument height mark**
- ⑤ **Illumination slot**
- ⑥ **Reflector**
- ⑦ **Peep sight**
- ⑧ **0° index**
When the circle positioning ring ⑨ is turned until the 0° button on the ring comes directly below the 0° index, 0° graduation is seen through the micrometer eyepiece.
- ⑨ **0° button**
This shows the location of 0° graduation of the horizontal circle.
- ⑩ **Lower fine motion**
- ⑪ **Leveling screw**
- ⑫ **Tribrach**
- ⑬ **Clamp screw of swivel lever**
Loosen the clamp screw immediately after you receive the instrument.
- ⑭ **Swivel lever**
When this is given half a turn in an anticlockwise direction, it is possible to lift the main body from the tribrach.
- ⑮ **Base plate**
- ⑯ **Lower clamp**
- ⑰ **Circular level adjusting screw**
The circular level adjusting screws can be turned with the adjusting pin to center the circular level bubble.
- ⑱ **Circular level**
- ⑲ **Circle positioning ring**
When the lower clamp ⑯ and horizontal clamp ⑳ are loosened, the horizontal circle can be turned with the ring.
- ⑳ **Eyepiece for optical plummet**
Turn the eyepiece to focus on the reticle.

- ① Adjusting screw for the reticle
- ② Objective lens
- ③ Opening for external battery converter No. 6860-01
- ④ Battery case
- ⑤ Battery cover clamp
Used to mount or dismount battery No. 6850-01 or external battery converter No. 6860-01.
- ⑥ Prism constant cover
When the cover is removed with a coin, prism constant setter and earth-curvature refraction switch are accessible. See page 60.
- ⑦ Micrometer eyepiece
Numbers on the both circles are focused by turning the eyepiece. See page 23.
- ⑧ Micrometer knob
See page 23.
- ⑨ Plate level adjusting screw
See page 77.
- ⑩ Tubular compass slot
- ⑪ Horizontal fine motion
- ⑫ Horizontal clamp
- ⑬ Plate level
- ⑭ Vertical fine motion
- ⑮ Vertical clamp
- ⑯ Start-stop switch
A push of the switch starts or stops distance measurement.
- ⑰ Telescope eyepiece
The reticle is focused by turning the eyepiece, see page 20.
- ⑱ Reticle adjustment cover
See page 79.
- ⑲ Focusing ring
To focus on a target.
- ⑳ Display
- Measured value is displayed.
 - Keyed-in numbers (i.e. angle or stake-out data) are displayed.
 - Unit of measurement, prism constant and atmospheric correction factor are displayed.

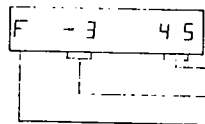
Example:

 is displayed when  key is pressed.
atmospheric correction factor; + 45 ppm
prism constant; - 3cm
unit of measurement; feet

- Necessary information is displayed:

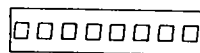
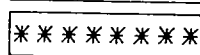

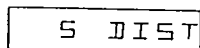
 : Shows display function and microcomputer works normally.

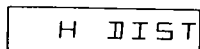

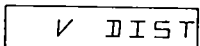
 : Before slope distance is measured.

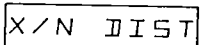
 : Before horizontal distance is measured.

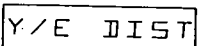
 : Before height difference is measured.

 : Before X coordinate is measured.

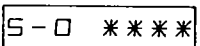
 : Before Y coordinate is measured.

 : When the  key is pressed.

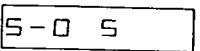

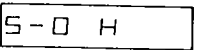
 : Before slope distance for stake-out is measured.

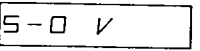
 : Before horizontal distance for stake-out is measured.

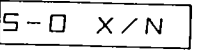
 : Before height difference for stake-out is measured.

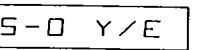

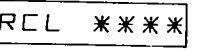
 : Before X coordinate for stake-out is measured.

 : Before Y coordinate for stake-out is measured.

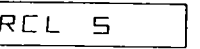
 : When the  key is pressed.

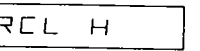
 : Before stored slope distance is recalled.

 : Before stored horizontal distance is recalled.

RCL V	:	Before stored height difference is recalled.
RCL X/N	:	Before stored X coordinate is recalled.
RCL Y/E	:	Before stored Y coordinate is recalled.
Z ANG	:	When the  key is pressed.
H ANG	:	When the  key is pressed.
S-O DIST	:	When the  key is pressed.
/	:	When the operation to display horizontal, zenith angle and stake-out data is discontinued or finished.
-	:	When no operation was done for more than 10 seconds.
-----	:	When no light comes back from the reflecting prism, before distance measuring.
SIG DOWN	:	When the reflected light from the prism was interrupted for more than 5 seconds.
BAT LOW	:	When the battery voltage is too low.
BAD COND	:	When atmospheric conditions are not suitable for distance measuring.
E 02	}	: When distance measuring function is not working properly.
E 03		

① Power switch

⑫ Keyboard

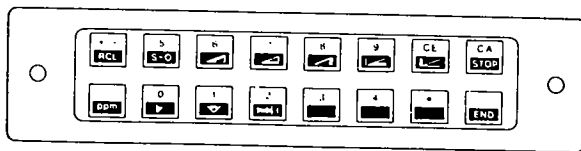















Fig. 2

Two functions are provided for the keys.

-  : ① To change the sign of keyed-in numbers.
 ② To recall distance data.
-  : ① To key in "5"
 ② To measure distance for stake-out.
-  : ① To key in "6".
 ② To measure slope distance.
-  : ① To key in "7".
 ② To measure horizontal distance.
-  : ① To key in "8".
 ② To measure height difference.
-  : ① To key in "9".
 ② To measure Y coordinate.
-  : ① To clear keyed-in numbers.
 ② To measure X coordinate.
-  : ① To discontinue recalling or keying in data.
 ② To discontinue distance measurement.
-  : ① No function
 ② To display unit of measurement, prism constant and atmospheric correction factor.
-  : ① To key in "0".
 ② To key in zenith angle.
-  : ① To key in "1".
 ② To key in horizontal angle.

 : ① To key in "2".
② To key in stake-out data.

 : ① To key in "3".
② No function.

 : ① To key in "4".
② No function.

 : ① To key in decimal point.
② No function.

 : ① No function.
② Press the key when keying-in is over.

- ⑬ **Audio target acquisition switch**
ON and OFF switch for buzzer circuit.
- ⑭ **ft/m switch**
Switching between feet and meter unit of measurement.
- ⑮ **Mode switch**
Switching between successive and tracking measurement.
- ⑯ **ppm setter**
Obtain atmospheric correction (page 61), and set the value.
- ⑰ **Light value lamp**
The lamp is ON when the light value is adequate.
- ⑱ **Gun sight**
To introduce the target into the field of view.

IV STANDARD SET

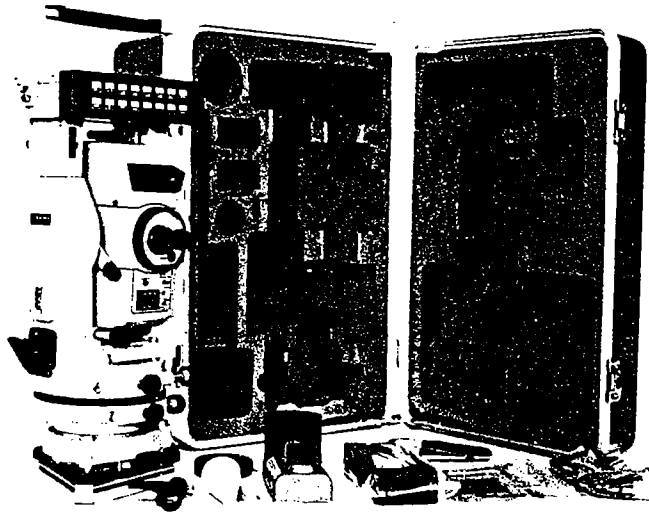

Fig. 3

SDM3E main unit	1	Screwdriver	1
Internal battery		Lens brush	1
No. 6850-01	1	Adjusting pin	2
Battery charger		Electric light bulb	1
No. 6855-01	1	Silicone cloth	1
Illumination package	1	Atmospheric correction	
Tubular compass	1	table	1
Lens cap	1	Layout	1
Lens hood	1	Operation manual	1
Vinyl cover	1	Carrying case	1
Tool bag	1		

Round Out Your Lietz EDM System with these Accessories

ROUND RETRO PRISMS

For use with all EDM systems recommending round retro prisms. Each prism is in a protective container which can be quickly detached from its metal mount. Lietz's standard prism offset for both triple and single assemblies is -30 mm. Triple mount sides are threaded permitting assembly of multiple mounts without any special brackets.

POCKET-SIZE RETRO PRISM
w/tilting mount
No. 7268-32



SINGLE ROUND TILTING PRISM
MOUNT only
No. 7269-34

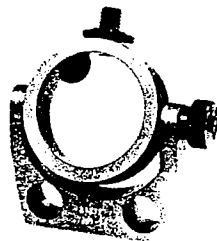

SIGHTING TARGET FOR RETRO PRISM

Adjustable height target with 5/8 x 11 mounting stud. Black anodized aluminum.



No. 7270-29

TRIPLE PRISM assembly
with mount and sighting pole.
(Pole not illustrated)
No. 7270-31



SINGLE PRISM assembly
with mount and sighting pole.
(Pole not illustrated)
No. 7270-32



TRIPLE MOUNT only
No. 7270-33

SINGLE MOUNT only
No. 7270-34

ROUND PRISM
w/container only (shown in assemblies)
No. 7270-35

RETRO PRISM CARRYING CASES

Vinyl plastic carrying case w/full zipper for easy access and storage. Inside padded. Exterior is bright international orange color. Sizes for single or triple retro prisms.
No. 7270-51 Triple retro prisms
No. 7270-52 Single retro prisms

LIETZ SIGHTING TARGET SET

No. 7311-45 contains one each of the following:

7269-34 Single Round Tilting Prism Mount

7270-35 Round Prism w/container

7270-29 Sighting Target for Retro Prism

7311-38 Tribrach Adaptor w/removable, rotatable center

7311-35 Optical Plummet Tribrach



TRIBRACHS AND ADAPTORS

OPTICAL PLUMMET TRIBRACH

For precision plumbing. Has circular level vial with sensitivity of 10 minutes per 2 mm.

Optical plummet focus by push-pull slide. Range :1.5 to 50 ft.

No. 7311-35



TRIBRACH LEVELING BASE

Same as above but without optical plummet.

For use with Azimuth Base (7150-41).

No. 7311-34



TRIBRACH ADAPTOR

Allows installation of retro prism or other accessories into tribrach.

5/8 x 11 thread.

No. 7311-37



TRIBRACH ADAPTOR

Similar to above except with removable, rotatable center.

No. 7311-38



TRAVERSE SET

WITH CARRYING CASE. For precise triangulation surveys, day or night.

No. 7312-45 Set contains two each of the following:

7311-35 Optical Plummet Tribrachs

7311-37 Tribrach adaptors

7312-39 Illumination units

7312-40 Rotatable sighting targets mounted on a base

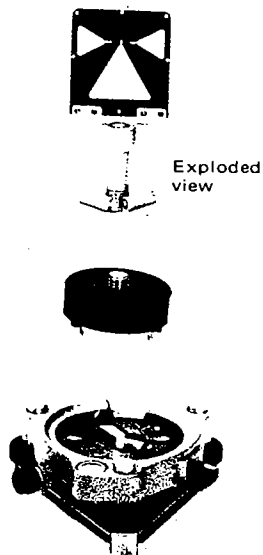

LARGE TARGET

Large target $8\frac{1}{4}'' \times 11\frac{3}{4}''$ attaches to regular target (No. 7312-40) to provide increased sighting range.

No. 7312-42

RANGE PLUMBING POLE

Aluminum tubing and brass fittings with hardened steel point. Height adjusts from 54" to 100". Upper section mounting stud accepts single or triple retro prisms; locking disc prevents prism rotation. Includes replaceable rod level (No. 8071-90). No. 7270-48



TELESCOPING RANGE PLUMBING POLE

Ideal for EDM and traverse work. Made of quality aluminum tubing with brass fittings and hardened steel point. Positive chuck style twist lock permits height adjustment from 54" to 100". Replaceable rod level (No. 8071-90) and point (No. 8078-50). Upper section has $\frac{5}{8} \times 11$ mounting stud to accept single or triple retro prisms. No. 7270-46



TRIPODS

Tripods recommended for use with these accessories (not included in price):

No. 7512-52 Wide Frame,
Extension Leg (wood)

No. 7536-75 Wide Frame,
Extension Leg (aluminum)

RANGE POLE SUPPORT

Made with metal center castings, rustproof steel legs w/one adjustable (hinged) leg for uneven ground.

No. 8078-90

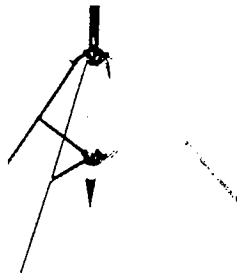

RANGE POLE TRIPOD

Heavy-duty. Made with metal center castings. Rustproof steel legs, adjustable for uneven ground.

No. 8078-95

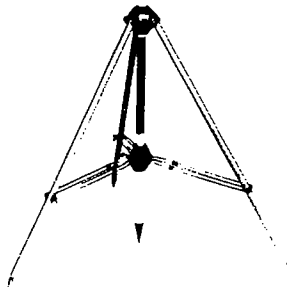

POCKET THERMOMETER

Refillable metal case. Mercury filled. Range: -30° to 120° F in 2° increments.

No. 8006-12

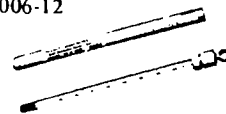

BAROMETER/ALTIMETER

with watch-type case.

English-Range 0-15,000 ft.

No. 8001-70



V OPERATION

1. Setting up the SDM3E

- (1) Setting up the tripod
 - 1) Loosen wing nuts A.

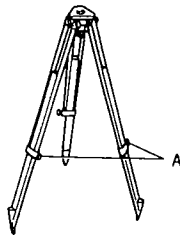

Fig. 4

- 2) Keep tripod closed and raise the tripod head to about chin level. Tighten wing nuts A.
- 3) Spread the tripod legs so that the three shoes form an equilateral triangle and the tripod head is positioned directly over the surveying point.
- 4) Make sure that:
 1. the tripod head is approximately level,
 2. the tripod shoes are firmly fixed in the ground.

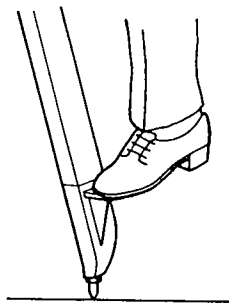
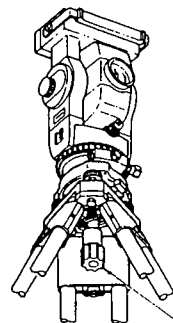

Fig. 5

If the ground is not solid enough, drive wooden stakes on which shoes are set.

(2) Center the SDM3E by adjusting leg length

- 1) Set the SDM3E on the tripod head. Support the instrument with one hand and screw the centering screw into the tribrach female thread. Tighten the centering screw.



Centering screw

Fig. 6

- 2) Turn the optical plummet eyepiece $\text{\textcircled{2}}$ to focus on the reticle. Then push or pull the eyepiece to focus on the surveying point.

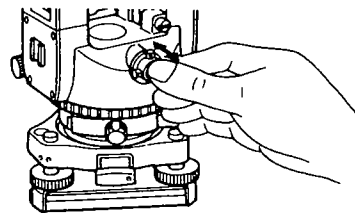
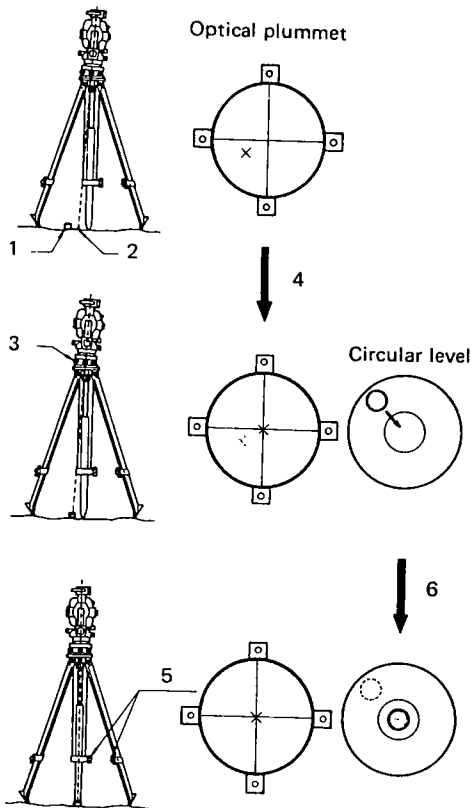

Fig. 7

- 3) Turn the leveling screws ① to center the surveying point in the reticle.



- 1 Surveying point
 2 Sighting position
 3 Leveling screw
 4 Look through the optical plummet and center the surveying point by turning the leveling screws.
 5 Extend the legs.
 6 The bubble should be centered by extending or shortening any of the three tripod legs.

Fig. 8

- 4) Now look at the circular level ④. Observe the off center direction of the bubble. Shorten a leg nearest to the direction, or extend a leg farthest from the direction. Generally, two legs have to be adjusted to center the bubble.
- 5) When centering of the circular level is completed, turn the leveling screws to center the plate level ③ bubble.

6) Look through the optical plummet again. If the surveying point is off-center, loosen the centering screw to center the surveying point on the reticle. Tighten the centering screw.

(3) Centering with the plumb bob

If the weather is calm, it is possible to use the plumb bob for centering. Unwind the plumb bob cord and attach it to the hook inside the centering screw. Use the cord grip piece to adjust cord length.

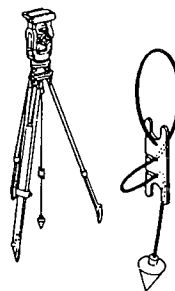

Fig. 9

(4) Focusing of the telescope

- 1) Loosen the vertical clamp ④ and horizontal clamp ⑦. Bring the target into the field of view with the peep sight ①. Tighten both clamps.
- 2) Looking through the telescope, turn the telescope eyepiece ② anticlockwise and stop turning just before the image of reticle becomes blurred. In this way, frequent refocusing can be dispensed with, since your eye is focused at infinity.
- 3) Turn the focusing ring ③ and focus on the target. Sight the target with the vertical ④ and horizontal fine motion ⑤. Focus on the target until there is no parallax between the target and the reticle.

Parallax: relative displacement of target image in respect to the reticle when observer's head is moved somewhat before the eyepiece.

If sighting is carried out before parallax is eliminated, this will introduce error in reading and will impair your observation.

(5) Sighting

1) Shift the target until it coincides with the central part of a reticle line or bisects a double line reticle by turning the fine motions clockwise. If the fine motion is turned too much, give one complete anticlockwise turn, then repeat another sighting with clockwise fine motion.

2) Position of target on the reticle line(s)
Horizontal angle: at a point close to the center of the vertical reticle.

Zenith angle: at a point close to the center of the horizontal reticle.

N.B. Use the same point of the reticle when the telescope face is changed.

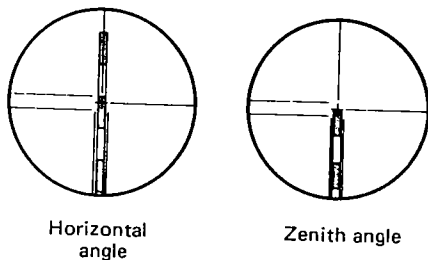

Fig. 10

For one reflecting prism with target, see N.B. on page 32.

(6) Swivel lever

Main unit of SDM3E is detachable from the tribrach. Give a 180° anticlockwise turn to the swivel lever ①. The main unit can be removed and replaced by other instruments such as a target, reflecting prism, etc.

To mount the instrument on the empty tribrach, open the swivel lever (180° anticlockwise turn), put the instrument in the tribrach, and turn the swivel lever clockwise until a click is heard.

N.B. For the new SDM3E just received, the swivel lever is fixed with a screws ②. Loosen it and keep it loosened.

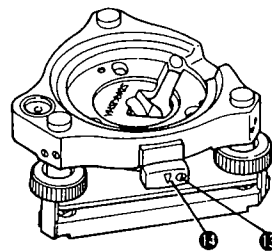

Fig. 11

2. Measuring angles

Before measuring angles, make sure that you have carried out the CHECKS AND ADJUSTMENTS of the SDM3E indicated on page 76.

Even for angle measurement, be sure the internal battery is mounted.

(1) Horizontal and vertical circle reading

Open the reflector ⑥. Turn the micrometer eyepiece ⑦ to focus on the graduations. Three windows are seen. See Fig. 12. The upper window marked V is for a degree of zenith angle. The lower window marked H is for a degree of horizontal angle. The small window on the right is for minutes and seconds of the both angles, and is thus known as MS window.

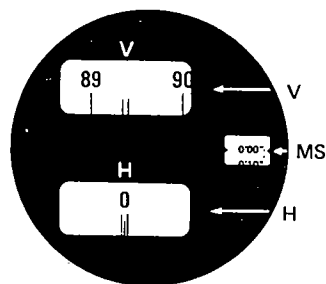

Fig. 12

1) Reading horizontal angle

Fig. 13 shows the appearance of the windows after the sighting. H and MS windows are used. In the H window, 128° and 129° graduations are seen on the both sides of the index line. Turn the micrometer knob ⑳ until the index line bisects the double line of either 128° or 129° graduation as in Fig. 14. The MS window shows $46'00''$. The horizontal reading is then $128^{\circ}46'00''$.

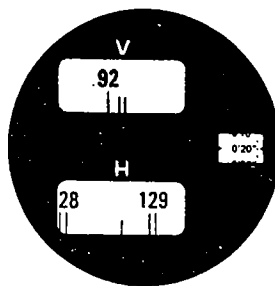

Fig. 13

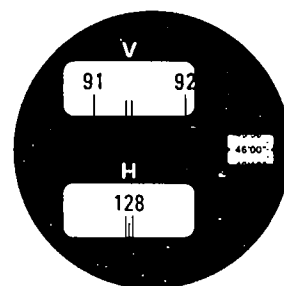

Fig. 14

2) Reading zenith angle

After the target is sighted, look at the V and MS windows. Two graduations are seen on the both sides of the double index line (Fig. 14). Turn the micrometer knob until either degree is centered in the double line as in Fig. 15. The zenith angle reading is then $92^{\circ}5'50''$.

N.B. Two displays of minutes and seconds may be seen in the MS window under certain circumstances. Read the figures lying closer to the arrow indices.

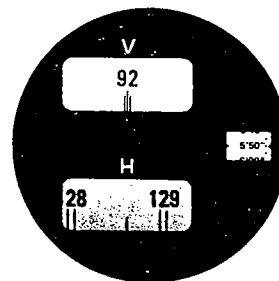

Fig. 15

(2) Horizontal angle measurement

1) Conventional (clockwise) measurement

- a. Sight the first target A. (Fig. 16)
- b. Turn the micrometer knob ② to read the horizontal circle.

Example: $44^{\circ}21'40''$ (Fig. 17)

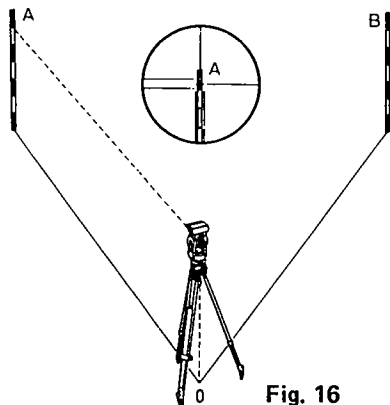

Fig. 16

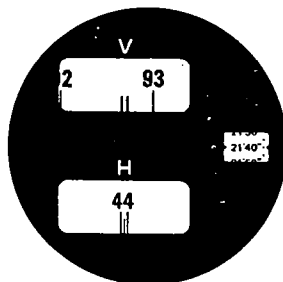

Fig. 17

- c. Use the horizontal clamp ⑦ and horizontal fine motion ④ to sight the second target B. (Fig. 18)
- d. Turn the micrometer knob and read the horizontal circle. Example: $125^{\circ}42'40''$ (Fig. 19)
- e. Subtract the 1st from the 2nd reading to obtain the angle AOB.

Example: $125^{\circ}42'40'' - 44^{\circ}21'40'' = 81^{\circ}21'00''$

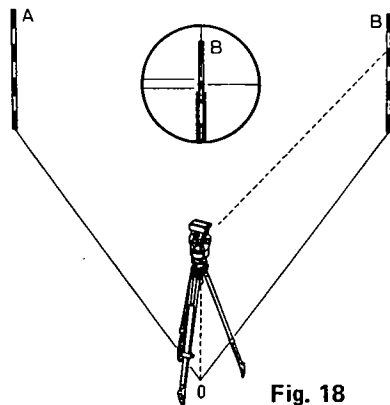

Fig. 18

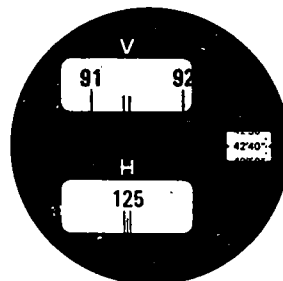

Fig. 19

- 2) Horizontal angle from $0^{\circ}00'00''$
- Turn the micrometer knob until $0'00''$ coincides with the arrow indices in the MS window.

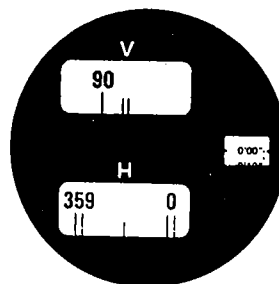

Fig. 20

- Loosen the horizontal clamp ⑫ and the lower clamp ⑬ and hold the upper alidade lightly. Turn the circle positioning ring ⑭ until the 0° button ① is aligned with the 0° index ②. Graduation 0° appears in the H window.
- Tighten the horizontal clamp ⑫ and turn the horizontal fine motion ③ until the index line bisects the 0° double line, Fig. 21.
- Guide the target A into the field of view. Tighten the lower clamp ⑬. Sight the target A with the lower fine motion ④. The target A is now in the direction of $0^{\circ}0'00''$, Fig. 22.

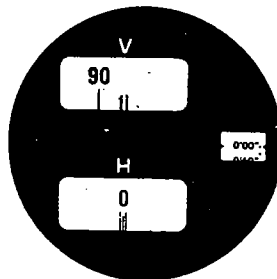

Fig. 21

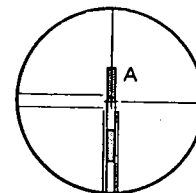

Fig. 22

- e. Loosen the horizontal clamp ⑩ . Introduce the target B into the field of view and tighten the horizontal clamp. Sight the target B with the horizontal fine motion ⑪ , Fig. 23.

Important: Do not bother with the lower fine motion ⑫ .

- f. Turn the micrometer knob to read the angle AOB.

Example: $81^{\circ}21'00''$ (Fig. 24)

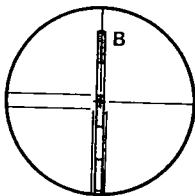

Fig. 23

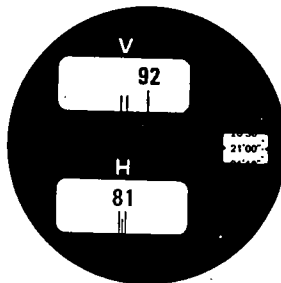

Fig. 24

3) Laying out a given angle

To find a point $90^{\circ}10'20''$ in a clockwise direction from the target A:

- Set the SDM3E at $0^{\circ}0'00''$ as in 2) a. to c. above, Fig. 25.
- Sight the target A using the lower clamp ⑩ and fine motion ⑪ , Fig. 26.

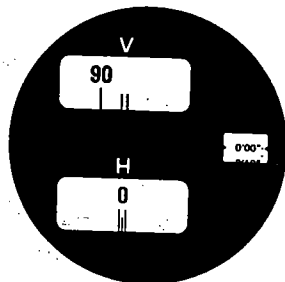

Fig. 25

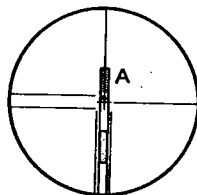

Fig. 26

- c. Turn the micrometer knob until 10'20" aligns with arrow indices of the MS window, Fig. 27.
- d. Loosen the horizontal clamp $\text{\textcircled{7}}$. Turn the instrument 90° clockwise. Tighten the horizontal clamp. Turn the horizontal fine motion $\text{\textcircled{1}}$ until the 90° double line is bisected by the H window index, Fig. 28.
- e. The direction sighted is 90°10'20" clockwise from the target A.

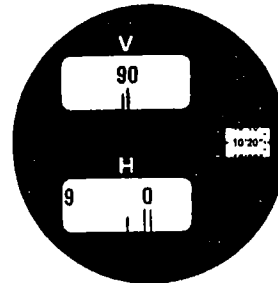

Fig. 27

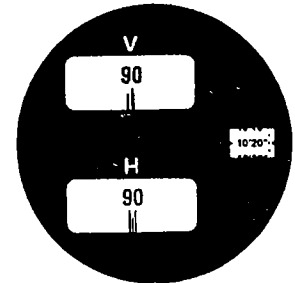

Fig. 28

(3) Zenith angle measurement

Zenith angle is 0° vertically upwards, 90° (face left), and 180° (face right) horizontally.

- 1) Sight the target in face left position and obtain the zenith angle FL. Example: FL = 82°35'30", Fig. 30

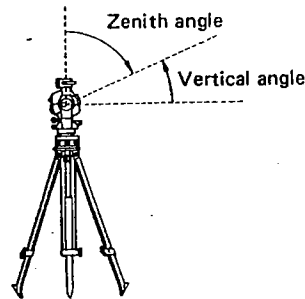

Fig. 29

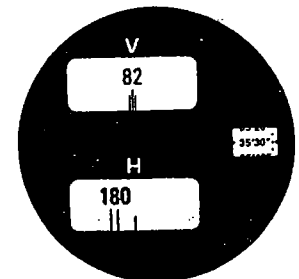

Fig. 30

- 2) Sight the target in face right and obtain the zenith angle
FR. Example: FR = 277° 24' 20"

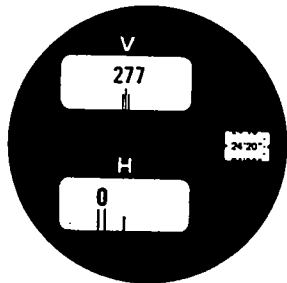

Fig. 31

- 3) Compute zenith angle by the formula:

$$\text{Zenith angle} = \frac{\text{FL} + 360^\circ - \text{FR}}{2}$$

Example:

$$\begin{aligned} \text{Zenith angle} &= \frac{82^\circ 35' 30'' + 360^\circ - 277^\circ 24' 20''}{2} \\ &= 82^\circ 35' 35'' \end{aligned}$$

- (4) Vertical angle

Obtain zenith angle as in 3) above, and subtract it from 90°.

N.B. The SDM3E has automatic zenith angle compensator. As far as the normal leveling of the instrument is done with the plate level, the compensated reading is obtained.

3. Distance measurement

(1) Preparation

- 1) Adjust the height of the reflecting prism with the four screws of the centering plummet so that the **TM10 PREC** mark is seen at the adjusting window. This is necessary to convert the slope distance to horizontal distance or to height difference.

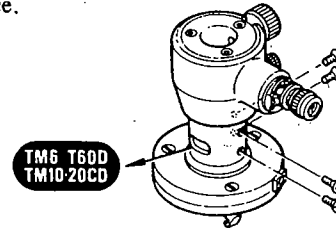

Fig. 32

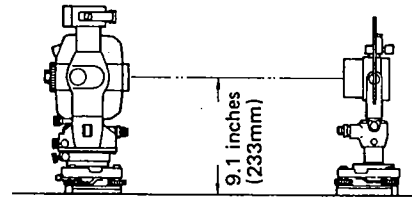
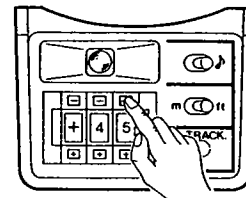

Fig. 33

- 2) Mount the internal battery No. 6850-01, see page 63.
- 3) Level the SDM3E and the reflecting prism.
- 4) Set the prism constant, earth-curvature and refraction correction, see page 60.
- 5) Set the atmospheric correction to the ppm setter

N.B. When the slope distance exceeds 6,561.66 ft (1,999.999m), see page 62.



Example: + 45 ppm

Fig. 34

- 6) Set the mode switch ⑬ to MEAS. for successive measurement, or to TRACK. for tracking.

MEAS: Successive
TRACK: Tracking

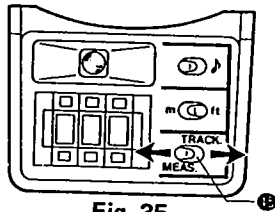

Fig. 35

- 7) Set the audio target acquisition switch ⑭ to J, and the ft/m switch ⑬ to ft (feet).

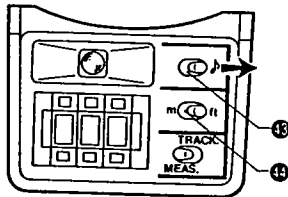

Fig. 36

- 8) Set the power switch ⑪ ON.
A short buzzing sound is heard when the power switch is ON.
Displays of Figs. 37 and then 38 show that the instrument is in normal condition.

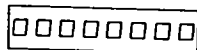

Fig. 37

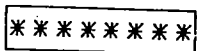

Fig. 38

1 second

N.B. 1. If no keys were operated for more than 10 seconds after the power is ON, display of Fig. 38 is replaced by that of Fig. 39.

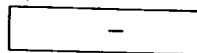

Fig. 39

N.B. 2. If Fig. 40 appears on the display after the power is ON, or while distance measurement, replace the battery with the charged one or charge the battery.

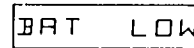

Fig. 40

N.B. 3. For unusual happening, refer to "2. Distance measuring function" on page 84.

- 9) Sight the center of the target with the telescope.
 - a. When the reflected light is caught by the telescope, buzzing sound is heard.
 - b. When the received light intensity is suitable for the SDM3E, the light value lamp ● lights up.

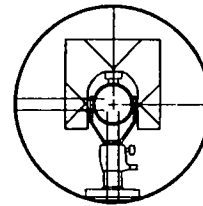

Fig. 41

N.B. 1. When the Light intensity coming back from the prism is very high, the light value lamp may light up even for a slight mis-sighting. Make sure that the target center is sighted correctly, Fig. 41.

N.B. 2. The reflecting prism w/ target plate (one prism) is designed for use at more than 10m distance. For distance less than 20m, the prism should be directed to the instrument carefully and the target center should be sighted correctly. It is recommended that the target is directed to the instrument even for the longer distance.

10) Switch off the audio target acquisition.

11) The SDM3E is now ready for slope distance measurement.

(2) Measuring the slope distance

- 1) Press the start-stop switch 

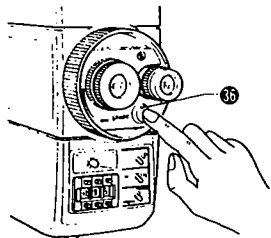

Fig. 42

- 2) For successive measurement, the slope distance is measured and displayed every 4 seconds.

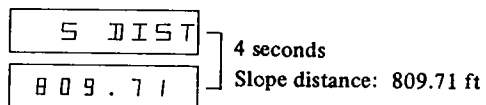
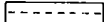



Fig. 43

When  is displayed, see page 85.

- 3) To stop measurement, give another press to the start-stop switch, or press  key.

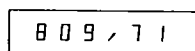



Fig. 44

- N.B. 1. Make sure a short buzzing sound is heard after every keying and measurement.
- N.B. 2. Maximum display for the slope distance is 6,561.66ft (1,999.999m).
For the longer slope distance, see page 62.
- N.B. 3. To measure other target, press the start-stop switch or  key. Then start sighting the target.
- N.B. 4. If two minutes have passed with or without any key operation after power is switched ON, the power is OFF automatically, and all the stored data are lost. OFF the power switch once, then ON.

(3) Keyboard operation

1) To input angle

a. Zenith angle (Example 1: $82^{\circ}46'30''$)

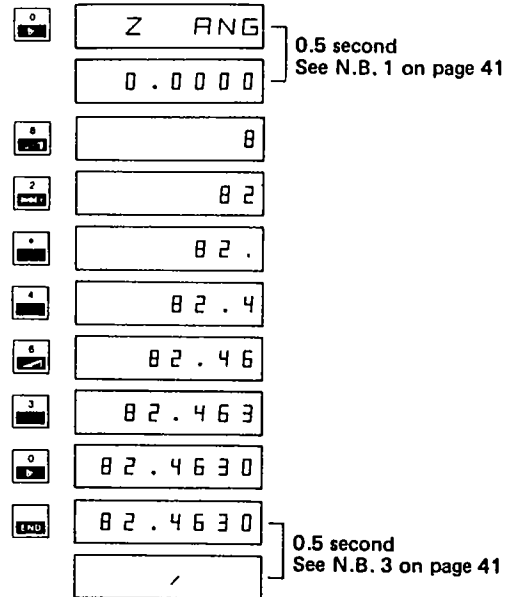

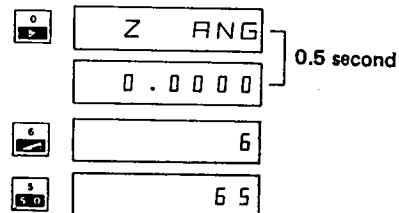

Fig. 45

Input of the keyed-in angle is done when  key is pressed.

(Example 2: 65°)



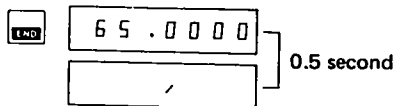

Fig. 46

When $65^{\circ}00'00''$ is keyed in, the result is the same as above.

(Example 3: $91^{\circ}28'30.5''$)

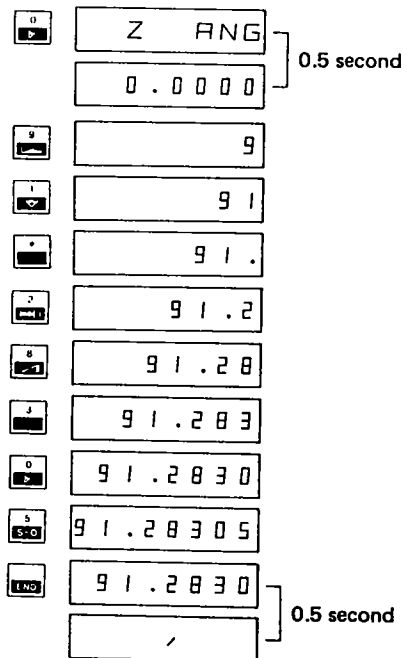

Fig. 47

Fractions of a second can not be keyed in.

b. Horizontal angle (Example: $74^{\circ}53'20''$)

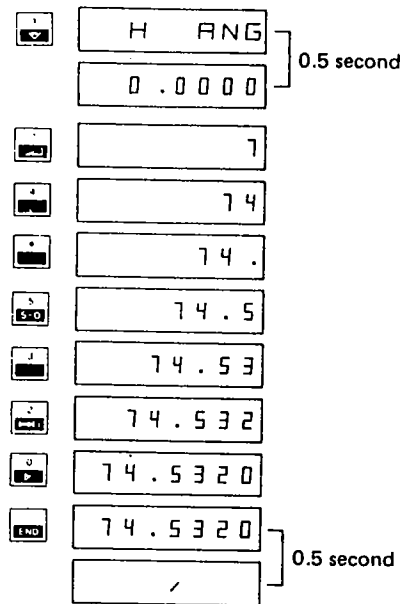

Fig. 48

The range of angle is between 0 and $999^{\circ}99'99''$.
Angle less than 0° is not accepted as an input.

When an angle larger than 360° is keyed in, the angle is converted to its equivalent less than 360° . However, the display is kept to the keyed-in figure.

Example: $585^{\circ}46'90''$ is converted to $225^{\circ}47'30''$.

By pressing \square or \square key,

\square is displayed.

- 2) To input stake-out data
 Stake-out data is a given distance or coordinate where a stake is supposed to be driven into the ground.
 The SDM3E displays the result of measured distance minus the given distance (stake-out data).
 (Example 1: 552.29 ft)

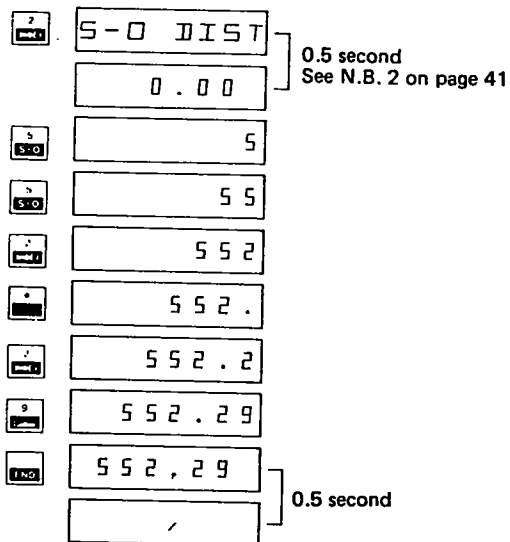
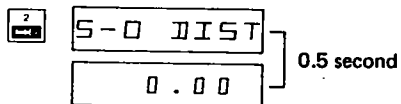

Fig. 49

(Example 2: 300ft)



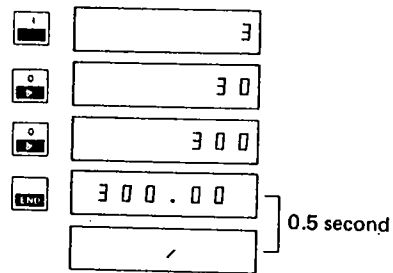

Fig. 50

The same effect results if 300.00 ft is keyed in. The range of stake-out data is between - 999.99 and 9,999.99 ft (- 999.999 and 9,999.999 m). Length less than 0.01ft (0.001m) is not accepted as an input.

3) To correct the input

a. Correction before the **END** key is pressed.

Example: to correct $1^{\circ}20'40''$ to $81^{\circ}20'00''$

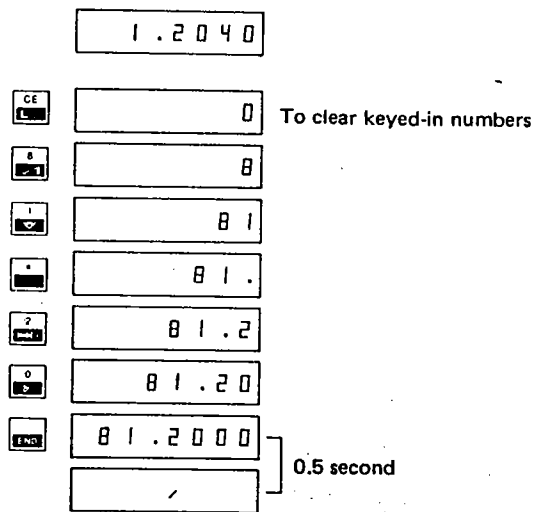



Fig. 51

- b. Correction after the  key is pressed.
 Example: to correct $1^{\circ}20'40''$ to $81^{\circ}20'00''$

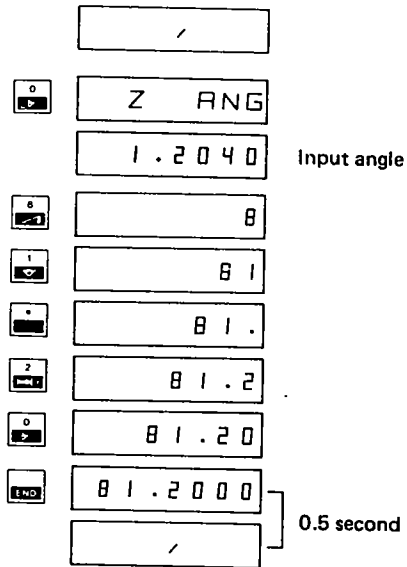



Fig. 52

- c. Correction of the stake-out data is the same as above.

- 4) To stop keying angle or stake-out data in
 Example: zenith angle $78^{\circ}56'30''$ has been keyed in. To stop storing a new angle 75° , just press  key.

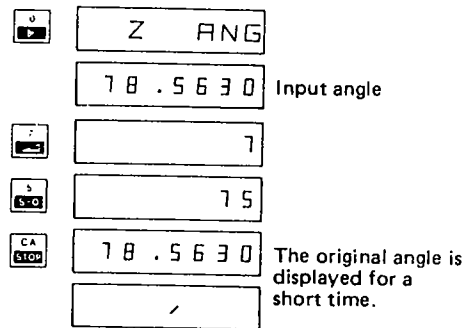







Fig. 53

The original angle $78^{\circ}56'30''$ is kept in the instrument when  key is pressed.

Press ,  or  key to input the next angle or stake-out data.

- 5) When angle over $999^{\circ}99'99''$ or stake-out data over 9,999.99 ft (9,999.999 m) or under -999.99 ft (-999.999 m) is keyed in and  key is pressed, the display flashes.

(Example 1: zenith angle $2,000^{\circ}50'$)

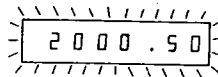

Fig. 54

(Example 2: stake-out data 10,001 ft)

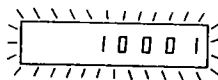



Fig. 55

To input the correct figures, press  key and key in the correct figures.

6) To confirm the input

Example: to confirm stake-out data

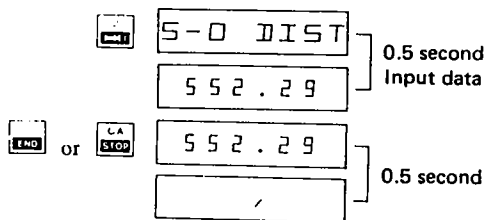

Fig. 56

- N.B. 1. When or key is pressed,
 a. stored angle is displayed,
 b. if the key is pressed after the power switch is ON, is displayed.
- N.B. 2. When key is pressed,
 a. stored stake-out data is displayed,
 b. if the key is pressed after the power switch is ON, is displayed.
- N.B. 3. The display shows that the keys .



.

can be operated.

(4) Mode of measurement

Kind of measurement		Mode	
		Successive: Measured and displayed successively	Tracking: Measured and displayed rapidly
Distance	Slope distance	① page 42	2 page 43
	Horizontal distance	③ page 44	④ page 44
	Height difference	⑤ page 45	⑥ page 46
	X coordinate	⑦ page 46	⑧ page 47
	Y coordinate	⑨ page 48	⑩ page 49
Stake-out	Slope distance	⑪ page 49	⑫ page 50
	Horizontal distance	⑬ page 51	⑭ page 52
	Height difference	⑮ page 52	⑯ page 53
	X coordinate	⑰ page 54	⑱ page 55
	Y coordinate	⑲ page 56	⑳ page 57

Fig. 57

- ① **Successive measurement of slope distance**
- Follow the instructions on pages 30 to 32.
 - Turn the mode switch  to MEAS.
 - Press the start-stop switch  or  key.

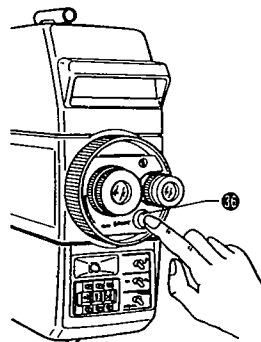

Fig. 58

- d. Slope distance is measured and displayed every 4 seconds.

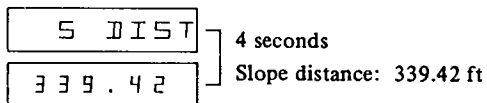



Fig. 59

- e. To stop measurement press the start-stop switch or  key. The last measurement is displayed. The decimal point is replaced by the sign “/”.

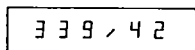





Fig. 60

② **Tracking of slope distance**

- a. Follow the instructions on pages 30 to 32.
b. Turn the mode switch  to TRACK.
c. Press the start-stop switch  or  key.

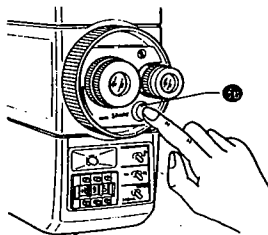

Fig. 61

- d. The first slope distance is displayed after 4 seconds, subsequent measurements are displayed every 0.3 second.

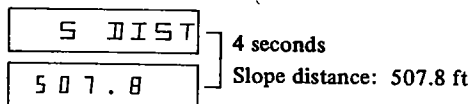



Fig. 62

- e. To stop measurement, press the start-stop switch or  key. The decimal point is replaced by the sign “/”.

N.B. 1. Distance down to 0.1 ft (0.01m) is displayed.

N.B. 2. Switching shutter sound is heard periodically.

5 0 7 , 8

Fig. 63

③ **Successive measurement of horizontal distance**

- Follow the instructions on pages 30 to 32.
- Turn the mode switch  to MEAS.
- Key in the zenith angle measured with the SDM3E, see page 34.

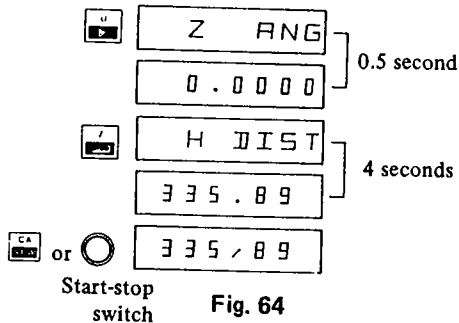

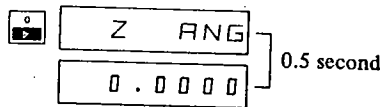
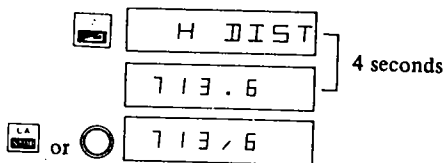

Fig. 64

④ **Tracking of horizontal distance**

- Follow the instructions on pages 30 to 32.
- Set the mode switch  to TRACK.
- Key in the zenith angle measured with the SDM3E, see page 34.





Start-stop
switch

Fig. 65

- N.B. 1. Measurement is displayed down to 0.1 ft (0.01m)
 N.B. 2. Shutter sound is heard periodically.

- ⑤ **Successive measurement of height difference**
- Follow the instructions on pages 30 to 32.
 - Set the mode switch  to MEAS.
 - Key in the zenith angle measured with the SDM3E, see page 34.

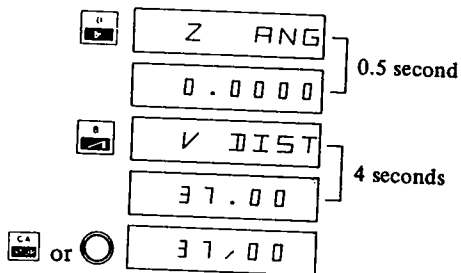

Start-stop
switch

Fig. 66

- N.B. When the height difference is less than -- 999.99 ft (- 999.999 m), the negative sign “-” is not displayed.

⑥ Tracking of height difference

- a. Follow the instructions on pages 30 to 32.
- b. Set the mode switch ④ to TRACK.
- c. Key in the zenith angle measured with the SDM3E, see page 34.

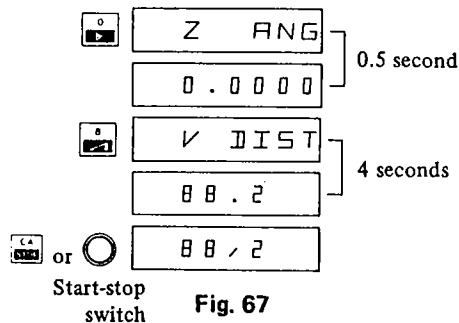

- N.B. 1. Measurement is displayed down to 0.1 ft (0.01 m).
 N.B. 2. Shutter sound is heard periodically.
 N.B. 3. When the height difference is less than - 999.9 ft (- 999.99m), the negative sign “-” is not displayed.

⑦ Successive measurement of X coordinate

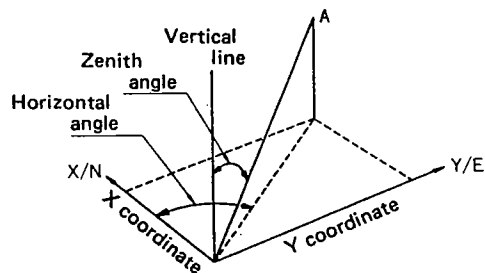
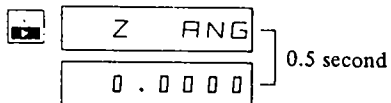

Fig. 68

- a. Follow the instructions on pages 30 to 32.
- b. Set the mode switch 45 to MEAS.

- c. Key in the zenith and horizontal angles measured with the SDM3E.



To key in zenith angle, see page 34.

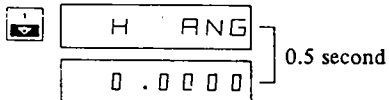

To key in horizontal angle, see page 36.

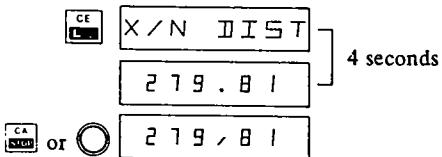

Start-stop
switch

Fig. 69

N.B. When the X coordinate is less than -999.99 ft (-999.999 m), the negative sign “-” is not displayed.

⑧ **Tracking of X coordinate**

- Follow the instructions on pages 30 to 32.
- Set the mode switch  to TRACK.
- Key in the zenith and horizontal angles measured with the SDM3E.

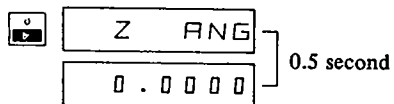

To key in zenith angle, see page 34.

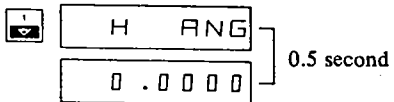

To key in horizontal angle, see page 36.

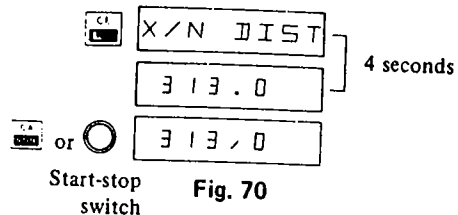
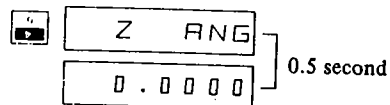

Fig. 70

- N.B. 1. The X coordinate is displayed down to 0.1 ft (0.01 m).
- N.B. 2. The first display after 4 seconds, the successive ones every 0.5 second. Shutter sound is heard periodically.
- N.B. 3. When the X coordinate is less than -999.9ft (-999.99m), the negative sign “-” is not displayed.

- ⑨ **Successive measurement of Y coordinate**
- Follow the instructions on pages 30 to 32.
 - Set the mode switch \odot to MEAS.
 - Key in the zenith and horizontal angles measured with the SDM3E.



To key in zenith angle, see page 34.

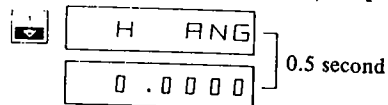

To key in horizontal angle, see page 36.

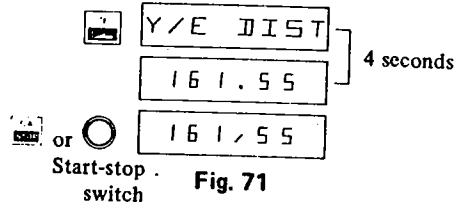

Fig. 71

- N.B. When the Y coordinate is less than -999.99ft (-999.999m), the negative sign “-” is not displayed.

⑩ **Tracking of Y coordinate**

- Follow the instructions on pages 30 to 32.
- Set the mode switch \oplus to TRACK.
- Key in the zenith and horizontal angles measured with the SDM3E.



To key in zenith angle, see page 34.

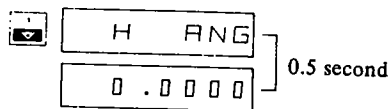

To key in horizontal angle, see page 36.

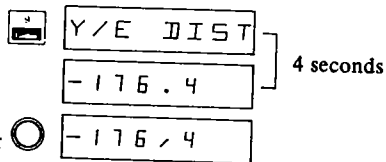

Start-stop
switch

Fig. 72

- The Y coordinate is displayed down to 0.1 ft (0.01m).
- The first display after 4 seconds, the successive ones every 0.5 second. Shutter sound is heard periodically.
- When the Y coordinate is less than - 999.9 ft (- 999.99 m), the negative sign “-” is not displayed.

⑪ **Successive measurement of slope distance stake-out**

- Follow the instructions on pages 30 to 32.
- Set the mode switch \oplus to MEAS.
- Key in the stake-out data. See page 37.

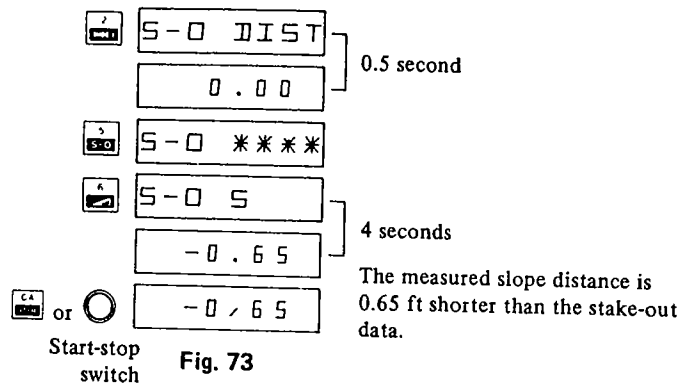

N.B. When the slope distance stake-out is less than -999.99 ft (-999.999m), the negative sign “-” is not displayed.

⑫ **Tracking of slope distance stake-out**

- Follow the instructions on pages 30 to 32.
- Set the mode switch **Ⓟ** to TRACK.
- Key in the stake-out data. See page 37.

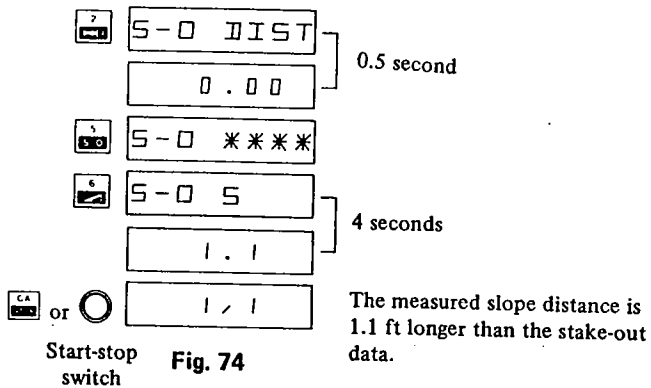

- N.B. 1. Measurement is displayed down to 0.1 ft (0.01m).
- N.B. 2. The first display after 4 seconds, the successive ones every 0.3 second. Shutter sound is heard periodically.
- N.B. 3. When the measurement is less than - 999.9 ft (-999.999m), the negative sign “-” is not displayed.

⑬ Successive measurement of horizontal distance stake-out

- a. Follow the instructions on pages 30 to 32.
- b. Set the mode switch  to MEAS.
- c. Key in the zenith angle. See page 34.

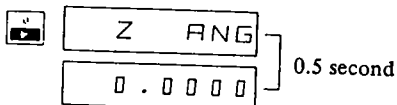

- d. Key in the stake-out data. See page 37.

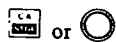
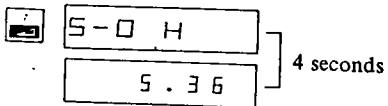
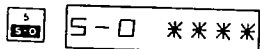
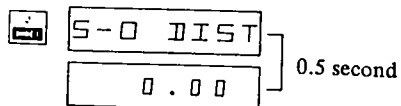

or
Start-stop
switch

Fig. 75

The measured horizontal distance is 5.36 ft longer than the stake-out data.

- N.B. When the measurement is less than - 999.99 ft (-999.999m), the negative sign “-” is not displayed.

14 **Tracking of horizontal distance stake-out**

- Follow the instructions on pages 30 to 32.
- Set the mode switch Ⓢ to TRACK.
- Key in the zenith angle. See page 34.

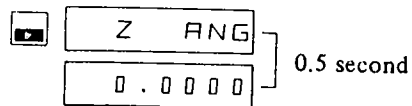

- Key in the stake-out data. See page 37.

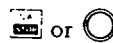
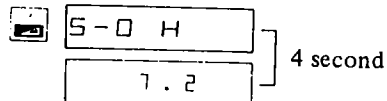
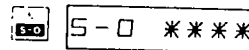
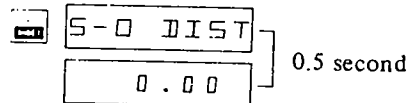

Start-stop
switch

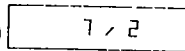

The measured horizontal distance
is 7.2 ft longer than the stake-out
data.

Fig. 76

- N.B. 1. Measurement is displayed down to 0.1 ft (0.01m).
- N.B. 2. The first display after 4 seconds, the successive ones every 0.4 second. Shutter sound is heard periodically.
- N.B. 3. When the measurement is less than - 999.9 ft (- 999.99 m), the negative sign “-” is not displayed.

15 **Successive measurement of height difference stake-out**

- Follow the instructions on pages 30 to 32.
- Set the mode switch Ⓢ to MEAS.
- Key in the zenith angle. See page 34.

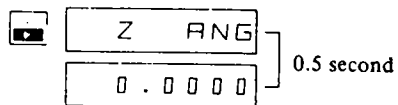

d. Key in the stake-out data. See page 37.

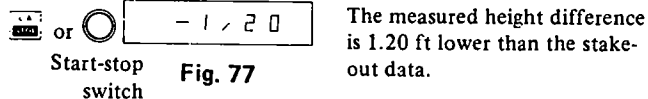
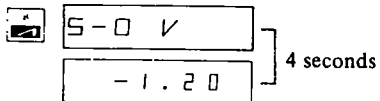
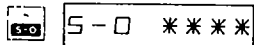
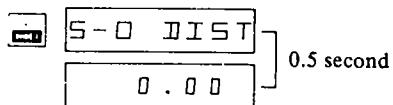

Fig. 77

N.B. When the measurement is less than -999.99 ft (-999.999 m), the negative sign “-” is not displayed.

⑩ **Tracking of height difference stake-out**

- Follow the instructions on pages 30 to 32.
- Set the mode switch to TRACK.
- Key in the zenith angle. See page 34.



d. Key in the stake-out data. See page 37.

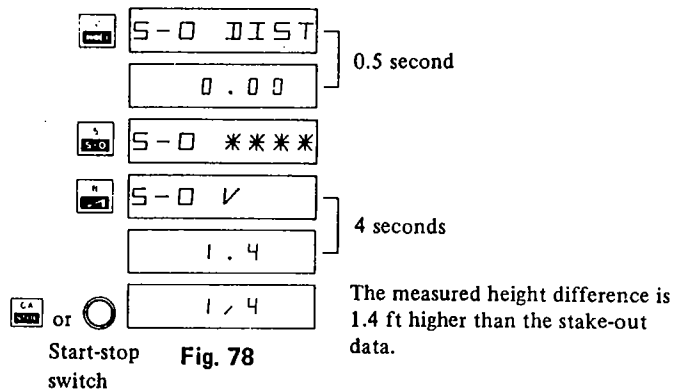

- N.B. 1. Measurement is displayed down to 0.1 ft (0.01m).
- N.B. 2. The first display after 4 seconds, the successive ones every 0.4 second. Shutter sound is heard periodically.
- N.B. 3. When the measurement is less than - 999.9 ft (-999.99 m), the negative sign “-” is not displayed.

- ⑰ **Successive measurement of X coordinate stake-out**
- a. Follow the instructions on pages 30 to 32.
 - b. Set the mode switch \odot to MEAS.
 - c. Key in the zenith and horizontal angles. See pages 34 to 36.

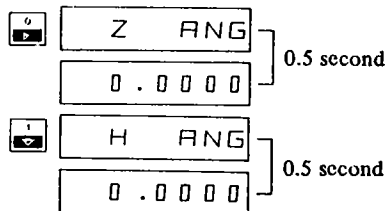

d. Key in the stake-out data. See page 37.

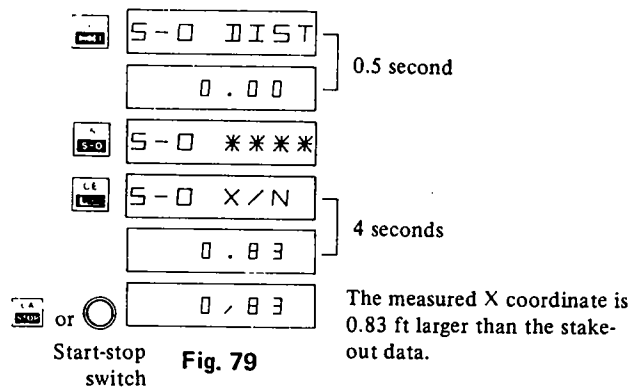

N.B. When the measurement is less than -999.99 ft (-999.999 m), the negative sign “-” is not displayed.

⑱ **Tracking of X coordinate stake-out**

- a. Follow the instructions on pages 30 to 32.
- b. Set the mode switch  to TRACK.
- c. Key in the zenith and horizontal angles. See pages 34 to 36.

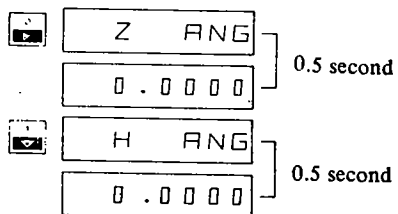

d. Key in the stake-out data. See page 37.

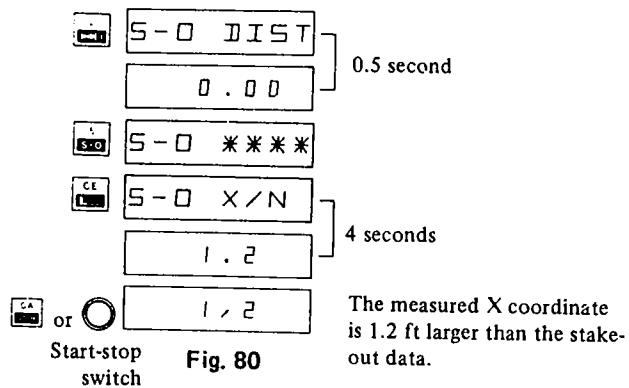

- N.B. 1. Measurement is displayed down to 0.1 ft (0.01m).
- N.B. 2. The first display after 4 seconds, the successive ones every 0.5 second. Shutter sound is heard periodically.
- N.B. 3. When the measurement is less than - 999.9 ft (- 999.99 m), the negative sign “-” is not displayed.

(19) **Successive measurement of Y coordinate stake-out**

- Follow the instructions on pages 30 to 32.
- Set the mode switch to MEAS.
- Key in the zenith and horizontal angles. See pages 34 to 36.

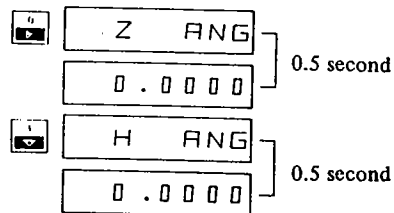

d. Key in the stake-out data. See page 37.

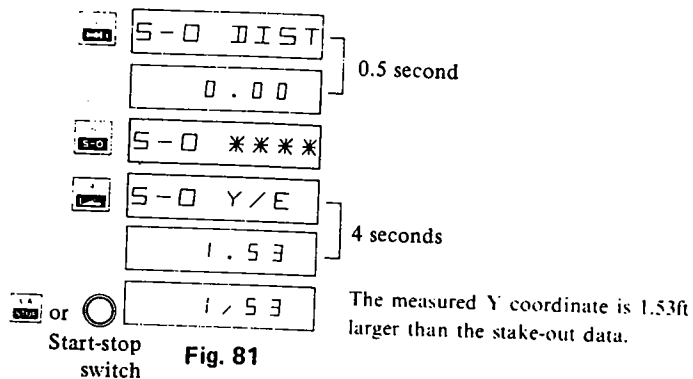

N.B. When the measurement is less than -999.99 ft (-999.999 m), the negative sign “-” is not displayed.

20 **Tracking of Y coordinate stake-out**

- Follow the instructions on pages 30 to 32.
- Set the mode switch **Ⓢ** to TRACK.
- Key in the zenith and horizontal angles. See pages 34 to 36.

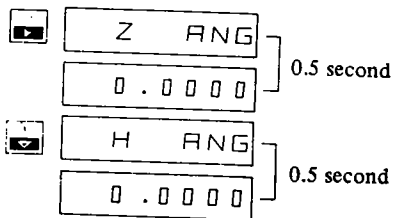

d. Key in the stake-out data. See page 37.

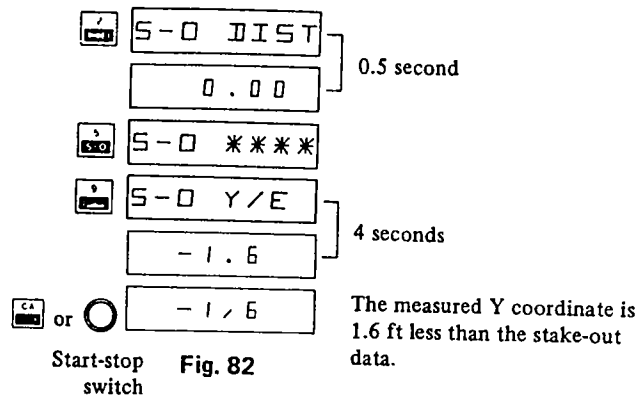







- N.B. 1. Measurement is displayed down to 0.1 ft (0.01m).
- N.B. 2. The first display after 4 seconds, the successive ones every 0.5 second. Shutter sound is heard periodically.
- N.B. 3. When the measurement is less than - 999.9 ft (- 999.99 m), the negative sign “-” is not displayed.

(5) To recall data

Slope distance
Horizontal distance
Height difference
Y coordinate
X coordinate

can be recalled with the  key.

To recall one of them, press  and then , , ,  or  key, Fig. 83.

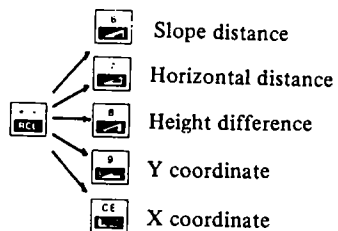

Fig. 83

Example: to recall height difference

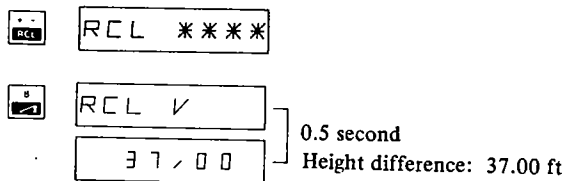



Fig. 84

To stop recalling after the  key is pressed.

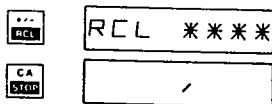



Fig. 85

VI CORRECTIONS

1. Prism constant

- (1) The prism constant of the Lietz/sokkisha reflecting prism is -3 cm. Remove the prism constant cover , and turn the index to 3 with a screwdriver.
- (2) Prism constant of 0 to -9 cm can be set in step of 1 cm.
Example: When the prism constant is -2 cm, set the index to 2.

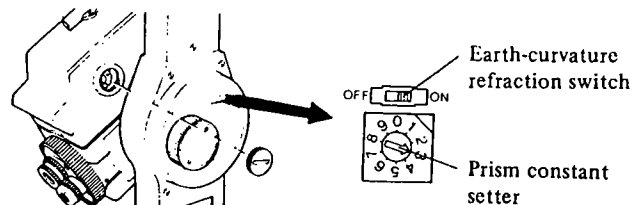



Fig. 86

2. Earth-curvature and refraction correction

- (1) To correct horizontal distance and height difference for earth-curvature and refraction, set the switch above the prism constant setter to ON.

 — Correction is applied.

 — Correction is not applied.

Fig. 87

The SDM3E computes the corrections by the formulas:

Corrected horizontal distance (ft)

$$= S \times \sin Z - 1.458 \times 10^{-7} \times S^2 \times \sin Z \times \cos Z$$

Corrected height difference (ft)

$$= S \times \cos Z + 6.733 \times 10^{-8} \times S^2 \times \sin^2 Z$$

Where S is the slope distance and Z is the zenith angle.

Example: slope distance $S = 5,000$ ft, zenith angle $= 80^\circ$
 Horizontal distance $= S \times \sin Z = 4,924.04$ ft
 Correction $= - 0.19$ ft
 Corrected horizontal distance $= 4,923.85$ ft
 (displayed)
 Height difference $= S \times \cos Z = 868.24$ ft
 Correction $= + 0.50$ ft
 Corrected height difference $= 868.74$ ft
 (displayed)

3. Atmospheric correction

The SDM3E is so designed that the correction factor is nil for temperature $+ 59^\circ\text{F}$ ($+15^\circ\text{C}$) and atmospheric pressure 29.9 inch Hg (760mmHg).

- (1) Pick up the correction factor from the atmospheric correction table (page 90).

Example: temperature $+65^\circ\text{F}$, atmospheric pressure 27 inch Hg

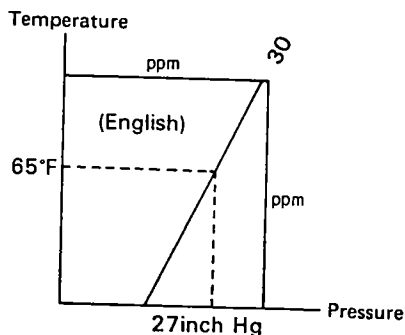
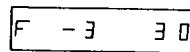

Fig. 88

The correction factor is 30ppm. Set the ppm setter \odot to +30.

N.B. Values of ppm and prism constant set to the SDM3E can be confirmed on the display by pressing the \square key.



atmospheric correction factor; +30 ppm
 prism constant; -3 cm
 unit of measurement; feet

Fig. 89

(2) To obtain the atmospheric correction factor by computation

1) inch Hg - °F system (english):

$$\text{Atmospheric correction factor} = 278.96 - \frac{10.5 \times P}{1 + 0.002175 \times t}$$

P; atmospheric pressure in inch Hg
 t; temperature in fahrenheit

Example: P = 29 inch Hg, t = +60°F

$$\text{ppm} = 278.96 - \frac{10.5 \times 29}{1 + 0.002175 \times 60} = 9.61$$

≈ 10

Set +10 to the ppm setter.

2) mmHg - °C system (metric):

$$\text{Atmospheric correction factor} = 278.96 - \frac{0.3872 \times P}{1 + 0.003661 \times t}$$

P; atmospheric pressure in mmHg
 t; temperature in centigrade

(3) Correction for the slope distance equal to or more than 6,561.67 ft (exceeding the maximum display 6,561.66 ft)

Compute the corrected slope distance by the formula:

$$D = (6,561.67 + d) \times \left(1 + \frac{X}{1,000,000}\right)$$

Where D; corrected slope distance
d; the display of slope distance when
ppm is set at 0
X; correction factor in ppm

Example: slope distance 6,594.48 ft (displayed as 32.81 ft),
X = + 5ppm

$$D = (6,561.67 + 32.81) \times \left(1 + \frac{5}{1,000,000}\right)$$
$$= 6,594.51 \text{ ft}$$

VII INTERNAL BATTERY No. 6850-01

1. Specifications

Battery:	NiCd
Supply:	1 hour at 77°F (25°C)
Output:	6V DC (1100mAh)
Size:	2.2 X 1.2 X 5.5 inches (55 X 30 X 140mm)

2. Handling

(1) Mounting

- 1) Confirm that the power switch is OFF.
- 2) Push the handle ① forward. Push the battery cover clamp ② forward (as shown by an arrow mark).
- 3) Open the battery case cover ③ and mount the battery in the case with the output connector facing the bottom.
- 4) Push the cover lightly and lock it with the clamp.
- 5) Set the power switch to ON.

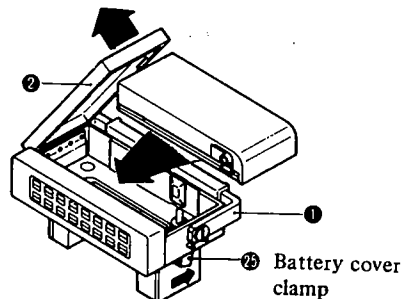

Fig. 90

(2) Dismounting

- 1) Confirm that the power switch is OFF.
- 2) Push the handle forward. Push the battery cover clamp to the direction of arrow.
- 3) Battery cover opens and the battery will spring up. Remove the battery.

N.B. To charge the internal battery, use the chargers for the internal battery exclusively.

3. Precautions

- (1) Charge the internal battery at temperature 50~104°F (10 to 40°C).
- (2) Be sure to use a fully charged battery.
- (3) Do not short circuit or disassemble the internal battery.
- (4) When disposing of the internal battery, it is dangerous to throw it into a fire.
- (5) Store the internal battery in a place where the temperature is below 95°F (35°C).
- (6) Charge the internal battery at least once a month if it is not used for a long time.
- (7) Do not leave the internal battery under direct sun light or beside a stove.
- (8) When the voltage of the charged internal battery drops quickly, it is necessary to replace the internal battery with a new one.
- (9) Do not use the internal battery for any other purpose.

VIII BATTERY CHARGER No.6855-01 FOR THE INTERNAL BATTERY

1. Specifications

Input:	120V AC, 50/60Hz
Output:	7.45V DC
Charging time:	12 hours at 77°F (25°C)
Charging temperature:	50 to 104°F (10 to 40°C)
Used for:	Internal battery No. 6850-01
Thermal protector:	257°F (125°C)
Output cable:	6.6 ft (2m)
Automatic cut off:	Not provided

2. Handling

- (1) Connect the internal battery No.6850-01, the battery charger No. 6855-01 to 120V AC as shown in Fig. 91.

N.B. Make sure the guide pin on the receptacle and the groove of the connector fit together. The connector should be inserted until a click is heard.

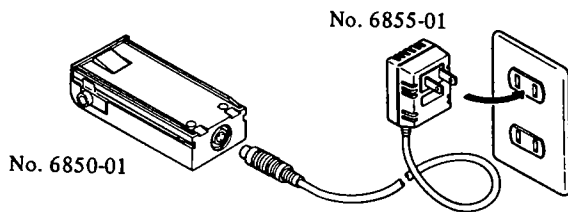

Fig. 91

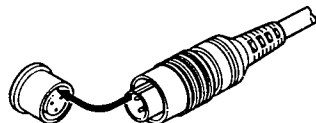

Fig. 92

- (2) While charging, the pilot lamp lights up.
- (3) Charge the internal battery for 12 hours.
- (4) When charging is completed, disengage the battery charger, plug and the internal battery.

N.B. Hold the ring as in Fig. 93, when the connector is removed.

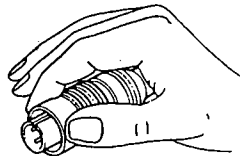

Fig. 93

3. Precautions

- (1) The battery charger may become warm while charging. This is normal and of no consequence.
- (2) Charge the internal battery at temperature 50 to 104°F (10 to 40°C).
- (3) Do not short circuit the output terminals.
- (4) When not in use, remove the output cable from the power source.
- (5) Do not charge the internal battery for any longer than specified.
- (6) When the internal battery is being charged, the process should be supervised at all times.
- (7) Do not use the battery charger for any other purpose.

IX OPTIONAL ACCESSORIES

1. Power source system for the SDM3E

The SDM3E can be operated under the following combinations.

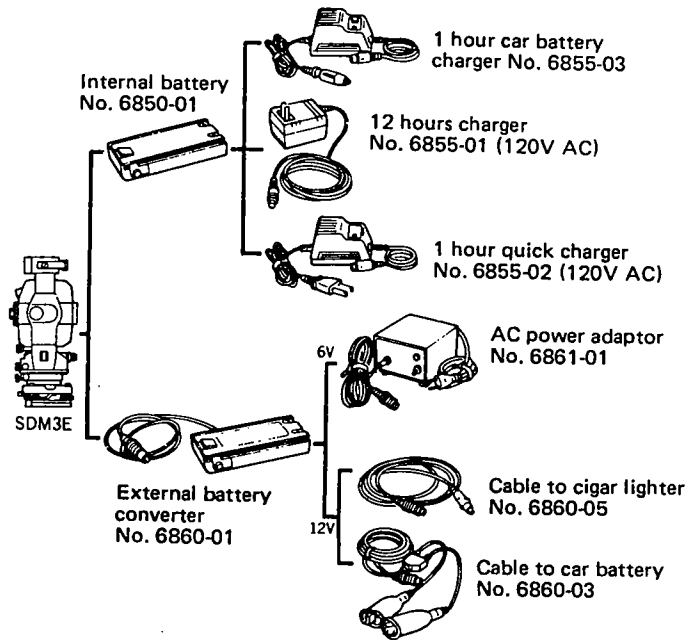

Fig. 94

N.B. Use the SDM3E exclusively in the combination shown here.

(1) 1 hour quick charger No. 6855-02

This is used for rapid charging of the internal battery No. 6850-01.

1) Specifications

Input:	120V AC
Output:	7.2V DC
Charging time:	1 hour approx.
Charging temperature:	50 to 104°F (10 to 40°C)
Battery to be charged:	No. 6850-01
Thermal protector:	257°F (125°C)
Input cable:	6.6 ft (2m)
Output cable:	1.6 ft (0.5m)
Automatic cut off:	Provided

2) Handling

- a. Connect the plug of input cable to AC.
- b. Connect the output cable to the battery No. 6850-01.
- c. Make sure the pilot lamp is lit.
- d. When charged, the charging current is automatically cut off and the pilot lamp becomes dim.
- e. If the plug is removed from the AC source for some reason while charging is being carried out, repeat a to d. above.

N.B. When the above procedure is not followed, the battery may not be charged.

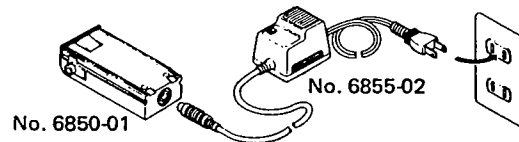

Fig. 95

3) Precautions

- a. Charge the battery at 50 to 104°F (10 to 40°C).
The higher the temperature, the longer the charging time. If charging takes place outside the tem-

perature range, the automatic cut off may not function.

- b. Do not use the No. 6855-02 more than three times successively to charge batteries.
- c. Even though the charging is automatically cut off, be sure to remove the plug from AC source.
- d. Also see "Precautions" on page 66.

(2) 1 hour car battery charger **No. 6855-03**

This charges the internal battery No. 6850-01 rapidly from the car battery.

1) Specifications

Input:	12V DC
Output:	7.2V DC
Charging time:	1 hour approx.
Charging temperature:	50 to 104°F (10 to 40°C)
Battery to be charged:	No. 6850-01
Thermal protector:	257°F (125°C)
Grounding:	The negative "-" terminal must be grounded to the chassis.
Input cable:	6.6 ft (2m)
Output cable:	3.3 ft (1m)
Automatic cut off:	Provided

2) Handling

- a. Start engine.
- b. Connect the input cable connector to the cigar lighter receptacle.
- c. Connect the output cable to the internal battery No. 6850-01.
- d. Press the start switch of the No. 6855-03 with a click sound.
- e. Make sure the pilot lamp is lit.
- f. If the input cable is removed from the cigar lighter receptacle, repeat a. to e. above.

N.B. When the above procedure is not followed, the battery may not be charged.

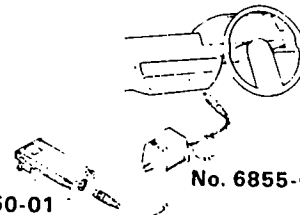

No. 6850-01

No. 6855-03

Fig. 96

3) Precautions

- a. The input cable heats up while charging. However, this is normal and of no consequence, as the input cable is a resistant cable.
- b. Do not heap up, bind or bend the cable while charging. Use the cable so as to radiate its heat effectively.
- c. Make sure the cable is not bound, bent or caught by door, seat, etc.
- d. Do not cut the cable short or replace it with another cable. Danger!
- e. Use the No. 6855-03 exclusively for cars where the negative terminal is grounded.
- f. Charge the battery with the engine running.
- N.B. Charging without running the engine will cause excessive discharge of the car battery.
- g. Keep children away from the charging site.
- h. Charge the battery at 50 to 104°F (10 to 40°C).
- N.B. The higher the temperature, the longer the charging time. If charging takes place outside the temperature range, the automatic cut off may not function.
- i. The No. 6855-03 heats up while charging. This is normal and of no consequence.
- j. Even though the charging is automatically cut off, be sure to remove the input cable.
- k. While the battery is not being charged, remove the input cable from the cigar lighter receptacle.
- l. Do not leave the site while charging.
- m. Do not use the charger for any other purpose.

(3) External battery converter No. 6860-01

This is an converter to connect the SDM3E to external power sources.

1) Specifications

Input: 6V or 12V DC, automatic switching
Output: 6V DC
Fuse metal and thermal protector: Provided
To be connected with: No.6860-03, No. 6860-05, No. 6861-01
Input cable: 3.3 ft (1m)

2) Handling

- a. Make sure the power switch ❶ is OFF.
- b. Set the No. 6860-01 into the battery case ❷.
- c. Connect the No. 6860-01 to external power source, see Fig. 94.

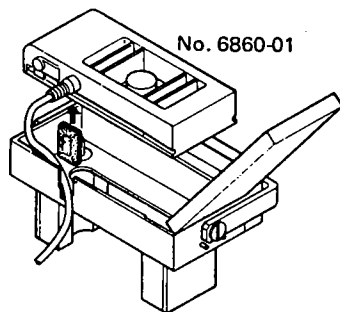

Fig. 97

3) Precautions

- a. Do not short circuit the output terminals.
- b. Do not use the No. 6860-01 for any other purpose.
- c. For 12V DC input, the No. 6860-01 heats up. However, this is normal and of no consequence.
- d. It is necessary to connect the No. 6860-01 to external power source, only after the No. 6860-01 is set in the battery case.

(4) AC power adaptor No. 6861-01

This is an external power source between No. 6860-01 and AC source.

1) Specifications

Input: 100V, 110V, 120V, 200V, 220V or 240V AC (All the above voltages are acceptable.)

Output: 7.5V DC

Input cable: 6.6 ft (2m)

Output cable: 9.8 ft (3m)

2) Handling

- a. Make sure the power switch ① is OFF.
- b. Connect the No. 6861-01 to the No. 6860-01 set in the battery case ②.
- c. **Select a proper voltage by turning the voltage selector on the rear side of the No. 6861-01, Fig. 98.**
- d. Connect the power source plug of the No. 6861-01 to an AC source.
- e. Set the power switch of the No. 6861-01 ON.
- f. Set the power switch of the SDM3E ON.

N.B. It is necessary to follow the above procedure a. to f.

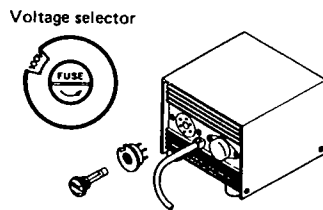

Fig. 98

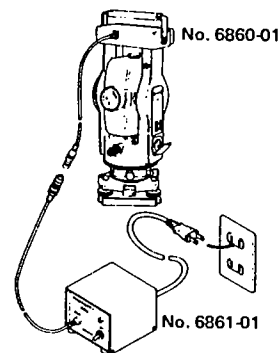

Fig. 99

3) Precautions

- a. Do not short circuit the output terminals.
- b. The No. 6861-01 will heat up. However, this is normal and of no consequence.
- c. Do not use the No. 6861-01 for any other purpose.

(5) Cable to cigar lighter **No. 6860-05**

This connects the external battery converter No. 6860-01 to the cigar lighter of the car.

1) Specification

Cable length: 16.4 ft (5m)

2) Handling

- a. Make sure the power switch ① is OFF.
- b. Connect the No. 6860-05 to the No. 6860-01 set in the battery case ② .
- c. Start engine.
- d. Connect the No. 6860-05 to the cigar lighter receptacle.
- e. Set the power switch ON.

N.B. Before the No. 6860-05 is removed from the cigar lighter receptacle, be sure the power switch of the SDM3E is OFF.

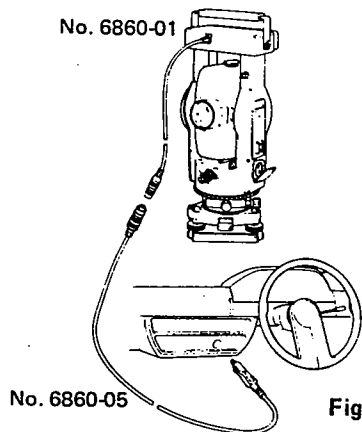

Fig. 100

3) Precautions

- a. Do not short circuit the output terminals.
- b. Make sure the cable is not bound, bent or caught by door, seat, etc.
- c. Make sure the car battery has 12V output.
- d. Use the No. 6860-05 exclusively for cars where the negative terminal is grounded (connected to the chassis).
- e. Do not use the No. 6860-05 for any other purpose.

(6) Cable to car battery No. 6860-03

This connects the external battery converter No. 6860-01 to the car battery.

1) Specification

Cable length: 16.4 ft (5m)

2) Handling

- a. Make sure the power switch ① is OFF.
- b. Connect the No. 6860-01 (set in the battery case ②) to the No. 6860-03.
- c. Start engine.
- d. Connect the red clip of the No. 6860-03 to "+" terminal of the car battery.
- e. Connect the black clip to the "-" terminal of the car battery.
- f. Set the power switch ON.

N.B. 1. Check thoroughly in order to prevent the risk of accidents, especially while the engine is running.

N.B. 2. Before disconnecting the No. 6860-03 from the car battery, be sure that the power switch of the SDM3E is OFF.

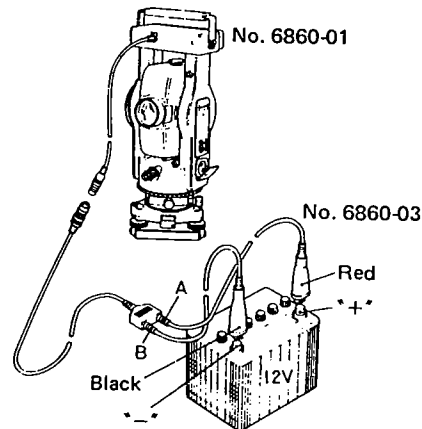

Fig. 101

3) Precautions

Refer to "Precautions" on page 73.

2. Diagonal eyepiece

The diagonal eyepiece is used conveniently for objects having a large altitude angle and at a place where space around the instrument is limited.

Remove the eyepiece ① by loosening the mounting ring and screw the diagonal eyepiece (telescope) in.

Remove the micrometer eyepiece ② by turning it anticlockwise and screw the diagonal eyepiece (micrometer) in.

When the diagonal eyepiece is used, the magnification is $\times 30$.

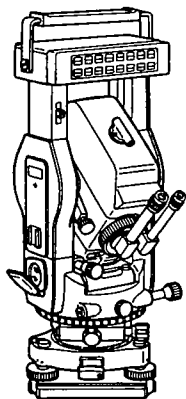

Fig. 102

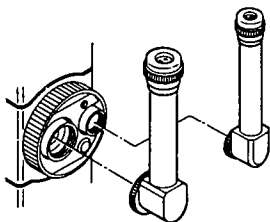

Fig. 103

X CHECKS AND ADJUSTMENTS

The SDM3E may be affected by sudden changes in weather conditions and excessive vibration. This can result in inaccurate surveying. Therefore, IT IS IMPORTANT TO CHECK AND ADJUST THE SDM3E BEFORE AND DURING USE in the following order.

1. Angle measuring function

- (1) Plate level
- (2) Circular level
- (3) Inclination of the reticle
- (4) Vertical reticle line
- (5) Horizontal reticle line
- (6) Coincidence of the distance measuring axis with the reticle
- (7) Optical plummet

(1) Plate level

The glass tube of plate level is sensitive to temperature change or shock. Be sure to check the plate level \otimes before use.

- 1) See Figs. 104 and 105 for relation between bubble movement and rotation of the leveling screws.

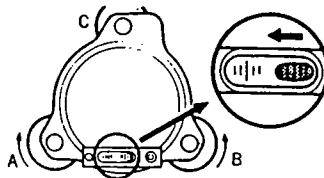

Fig. 104

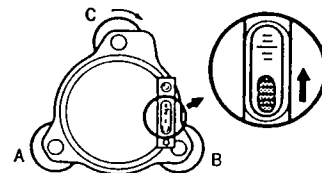

Fig. 105

- 2) Turn the upper part of the SDM3E until the plate level is perpendicular to a line between leveling screws A and B. Then center the bubble by means of the leveling screw C.

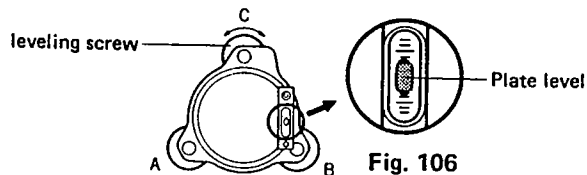

Fig. 106

- 3) Turn the upper part 90° until the plate level is parallel to the line between leveling screws A and B. Then center the bubble by turning the leveling screws A and B by the same amount and in opposite direction.

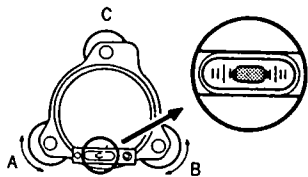

Fig. 107

- 4) Turn the upper part 180° . Correct the bubble deviation, if any, by half amount with the leveling screws A and B, as in 3) above.

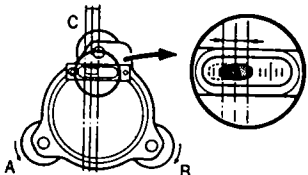

Fig. 108

- 5) Correct the remaining half deviation by turning the plate level adjusting screw ② with adjusting pin.

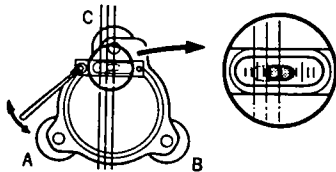

Fig. 109

- 6) Repeat 2) to 5) above until the bubble remains centered for all the positions of the upper part.

(2) Circular level

When the plate level adjusting is completed, the circular level ⑩ should be checked. Note the direction of the bubble de-centering. Loosen the adjusting screw ⑪ farthest from the direction and tighten the other adjusting screws to center the bubble.

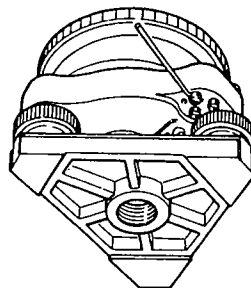

Fig. 110

(3) Inclination of the reticle

- 1) Select and sight a clear target on the upper part A of the vertical reticle line, Fig. 111.
- 2) Turn the telescope slowly upward with the vertical fine motion ⑫ until the target slides to the lower part B, Fig. 112. If the target is still bisected by the vertical line, no adjustment is necessary.

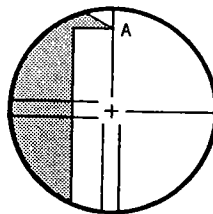

Fig. 111

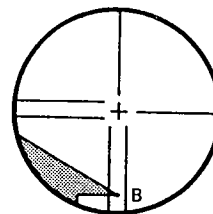

Fig. 112

- 3) If the target at B is not on the reticle, rotate the reticle plate by loosening the four adjusting screws.

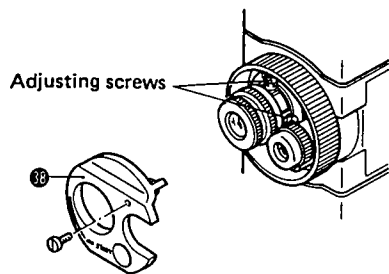

Fig. 113

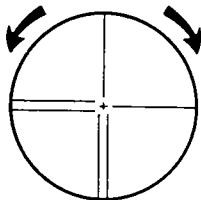

Fig. 114

(4) Vertical reticle line

When the vertical reticle line is in the correct position, the two readings on both faces of the telescope differ by 180° exactly.

- 1) Level the SDM3E. Select a clear target at a horizontal distance of about 330 ft (100m).

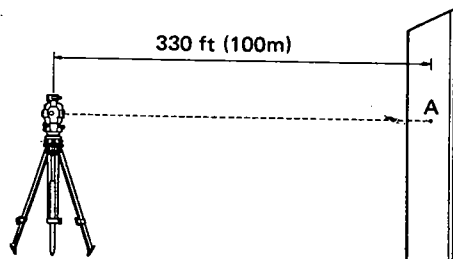

Fig. 115

- 2) Take the face left reading (A), $5^\circ 16' 10''$ e.g.

- 3) Plunge the telescope and take the face right reading (B),
 $185^{\circ}16'30''$ e.g.

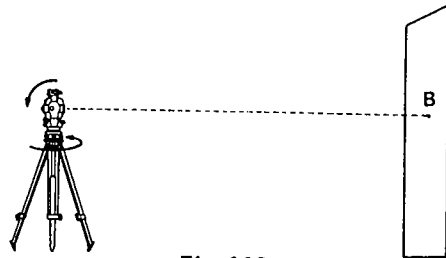

Fig. 116

- 4) Computer $\frac{A+B}{2} + 90^{\circ}$, and set it to the minute-second window of the micrometer by turning the micrometer knob.

$$\frac{5^{\circ}16'10'' + 185^{\circ}16'30''}{2} + 90^{\circ} = 185^{\circ}16'20''$$

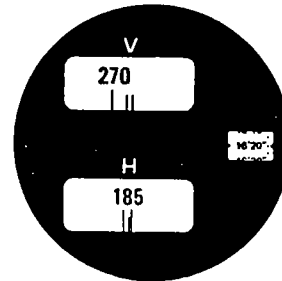

Fig. 117

- 5) Turn the horizontal fine motion $\text{\textcircled{1}}$ until the index line bisects the double line of a degree.

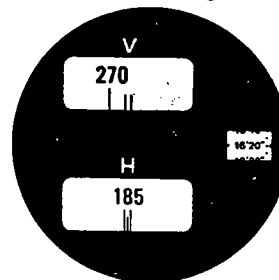

Fig. 118

- 6) Look through the telescope. The target is seen shifted from the vertical reticle line. Adjust the reticle sideways with the adjusting screws until the vertical line bisects the target.

N.B. The side shift of the reticle may also cause a slight vertical shift. Therefore, it is recommended to record the zenith angle before and after the side shift for checking.

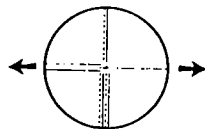

Fig. 119

(5) Horizontal reticle line.

When the horizontal reticle line is in the correct position, the zenith angle readings on both faces add up to 360° exactly.

- 1) Level the SDM3E. Select a clear target at a horizontal distance of about 330 ft (100m). Take the zenith angle reading (A) of the target on face left.
- 2) Plunge the telescope and take another reading (B) of the same target on face right.
- 3) When the two reading do not add up to 360° , compute $\frac{B - A}{2} + 180^\circ$ and set it to the minute-second window by turning the micrometer knob.

Example: $A = 89^\circ 10' 00''$, $B = 270^\circ 50' 20''$

$$\frac{270^\circ 50' 20'' - 89^\circ 10' 00''}{2} + 180^\circ = 270^\circ 50' 10''$$

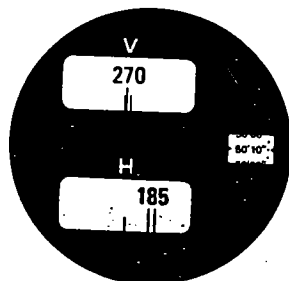

Fig. 120

- 4) Turn the vertical fine motion \oplus until a degree line bisects the double index lines.
- 5) Look through the telescope, the target is seen shifted from the horizontal reticle line. Adjust it up or down with the adjusting screws until the horizontal line bisects the target.

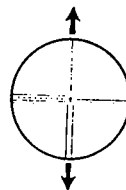

Fig. 121

N.B. If amount of the reticle shift is too large, distance measuring may be affected. Do not adjust the reticle more than 20''.

- (6) Coincidence of the distance measuring axis with the reticle
When the reticle is adjusted, check the distance measuring axis relative to the reticle as follows.

- 1) Level the SDM3E on the tripod. Set up the reflecting prism at a horizontal distance of 165 to 330 ft (50 to 100 m).

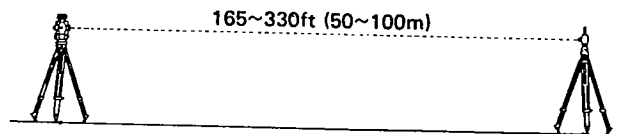

Fig. 122

- 2) Sight the reflecting prism center and take the horizontal and zenith angle readings (H and Z respectively).

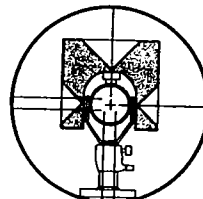

Fig. 123

- 3) Set the power switch ① ON and make sure the light value lamp ⑦ lights up.
- 4) Four more readings are necessary. Turn the horizontal or vertical fine motion slowly until the light value lamp becomes dark. Then take readings.

Readings H_l, H_r : when the telescope is directed to the left (right) of the sighted direction in 2) above.

Readings Z_a, Z_b : when the telescope is directed above (below) the sighted direction in 2) above.

- 5) Check the differences of H_l (H_r) against H , and Z_a (Z_b) against Z .

When the four differences are larger than 4', the coincidence is normal. If any difference is equal to or smaller than 3', please contact our agent.

(7) Optical plummet

- 1) Level the SDM3E. Center a surveying point to the reticle of the optical plummet. Loosen the horizontal clamp and turn the upper part through 180°. When the surveying point is still centered, adjusting is not necessary.
- 2) If the surveying point is decentered, correct half the deviation with the four adjusting screws ②, and correct the remaining half with the leveling screws.
- 3) Repeat the adjustment if necessary.

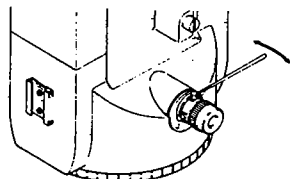

Fig. 124

2. Distance measuring function

The SDM3E has been manufactured to the highest standard of quality control and rarely needs checking. However, if, for some reason, the SDM3E is not functioning properly during use, carry out the following checking procedures. Make sure that prism constant, atmospheric correction and earth-curvature and refraction corrections are correctly set.

(1) Self-diagnosis

Distance measuring function is checked by the self-diagnosis system:

1) Set the power switch ON.

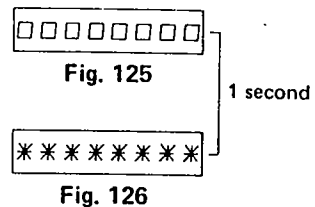

- a. When the distance measuring function is free from any defects, Figs. 125 and 126 are displayed in that order with a short sound for each. The self-diagnosis is completed in one second.



- b. When the Figs. 125 and 126 are not displayed, refer to "(2) Check flow chart" on page 86.

- 2) In case of some defect in the distance measuring function, the error messages in the following table is displayed after the power switch is ON, or during distance measuring.

DISPLAY	MEANING	ACTION
BAT LOW	Battery voltage is too low.	Replace the battery with a charged one, or charge the battery.
	Incoming reflected light is too dim or totally absent when the instrument is ready for distance measuring.	Sight the reflecting prism again. Increase the number of the reflecting prisms for long distance. Measure the distance again confirming the condition with the light value lamp or buzzing sound.*
SIG DOWN	Incoming reflection decreased during measurement. Incoming reflection was disturbed.	
BAD COND	Measuring conditions are poor.	Resight the prism and measure the distance again.* When the display appears frequently, contact our agent.
E 02 E 03	Defect in measuring function	Contact our agent.

* Stop measuring with the start-stop switch  or the  key. Then sight the prism and measure the distance.

(2) Check flow chart

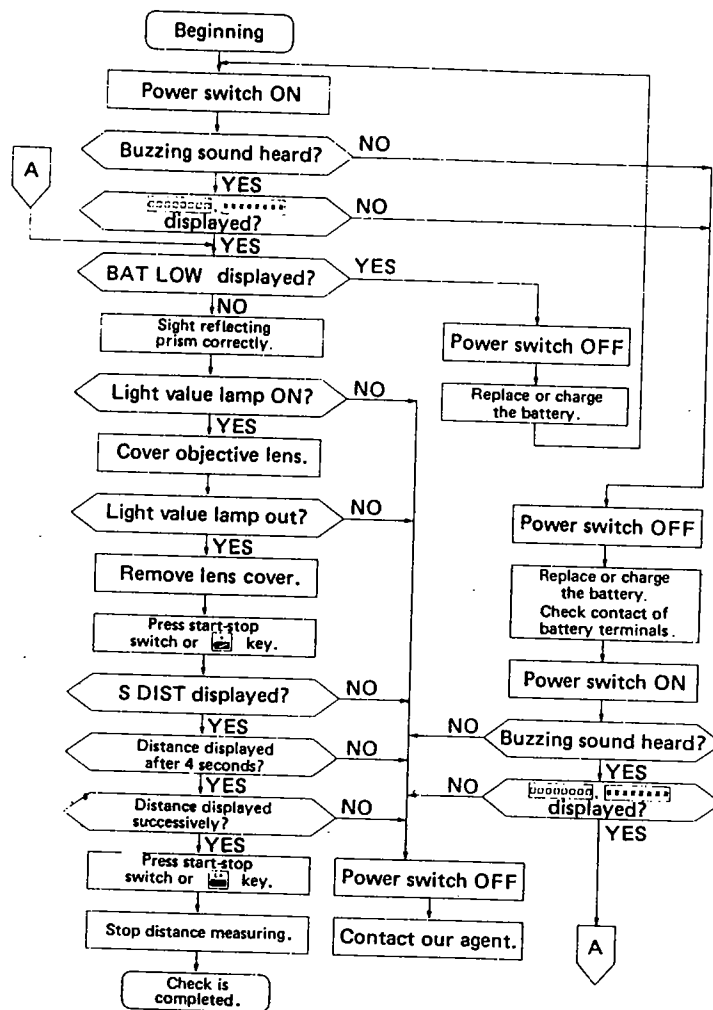

Fig. 127

XI CONFIRMATION OF DISTANCE CONSTANT

The SDM3E is quality-controlled to have a nil distance constant. The distance constant rarely changes. However, when some constant error seems to exist in measurements or as a periodical check (several times a year), check the distance constant as follows.

1. Confirmation of the distance constant K.
Select points A and B on a flat ground about 330 ft (100 m) in between, and C in the middle.
2. Set up the SDM3E at A, and measure the distance AB.

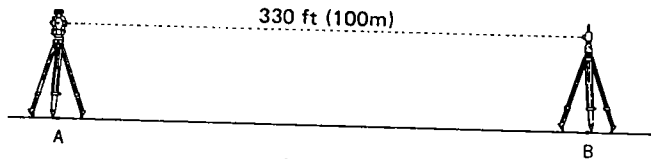

Fig. 128

3. Shift the SDM3E to C, and measure the distances CA and CB.

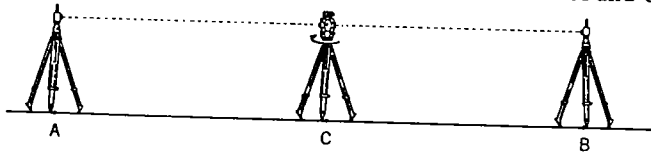

Fig. 129

4. Compute the distance error K with the formula:
$$K = AB - (CA + CB)$$
5. Obtain K more than two or three times. If the K is far from nil, contact our agent.

XII PRECAUTIONS AND MAINTENANCE

1. Precautions

- (1) When the SDM3E is kept unused for a long time, check it at least once every three months.
- (2) Handle the SDM3E with care. Avoid heavy shocks or vibration.
- (3) When something unusual is found on the rotatable portion, screws and optical parts (lens e.g.), contact our agent.
- (4) When taking the SDM3E out of the carrying case, never pull it out by force. The empty carrying case should be closed.
- (5) Never place the SDM3E on the ground directly.
- (6) **Never carry the SDM3E on the tripod to another site.**
- (7) Protect the SDM3E with an umbrella against direct sun light, rain and humidity.
- (8) When the operation leaves the SDM3E, the viny cover should be placed on the instrument.
- (9) Do not direct the telescope at the sun.
- (10) Always switch the power off when taking the internal battery out of the SDM3E.
- (11) Always take the battery out of the SDM3E when returning it to the case.
- (12) Do not wipe the carrying case with an organic solvent.
- (13) When the SDM3E is put in the carrying case, follow the layout plan.

2. Maintenance

- (1) Completely wipe off any moisture if the instrument gets wet during survey work.
- (2) Always clean the instrument before returning it to the case. As for the lens, dust it off with the lens brush first, to remove minute sand. Then, after providing a little condensation by breathing on the lens, wipe it with soft clean cloth or lens tissue.
- (3) Store the SDM3E in a dry room where the temperature does not change markedly.
- (4) If the battery is discharged excessively, its life may be shortened. Store it in a charged state.
- (5) Check the tripod for loose fit and loose screws.
- (6) To keep a high accuracy of the SDM3E, periodically check it once or twice a year.

ATMOSPHERIC CORRECTION TABLE (English)

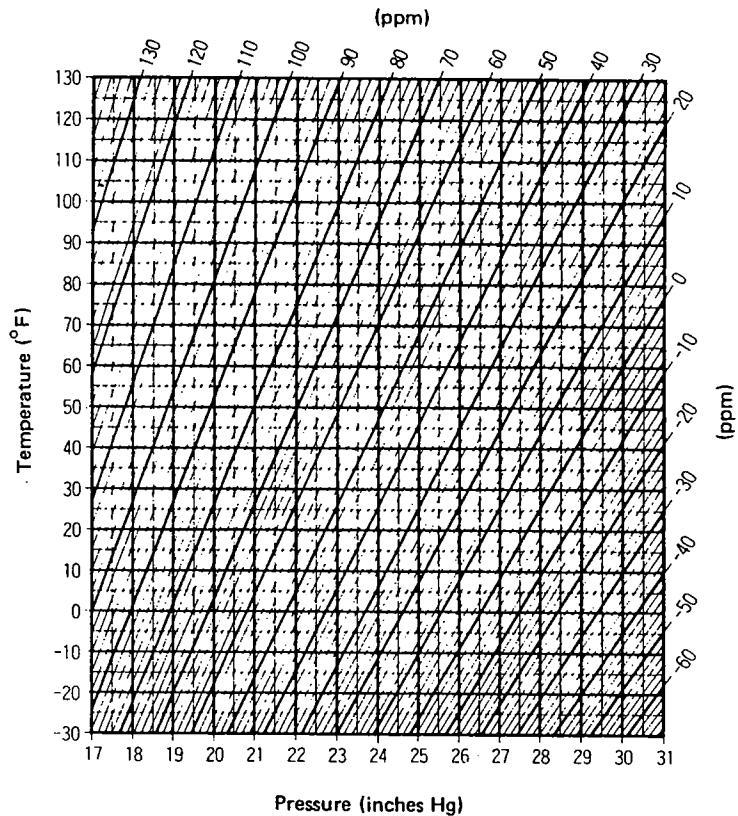

The table shows the correction every two ppm, while the atmospheric correction can be applied to the SDM3E for every ppm.

ATMOSPHERIC CORRECTION TABLE (Metric)

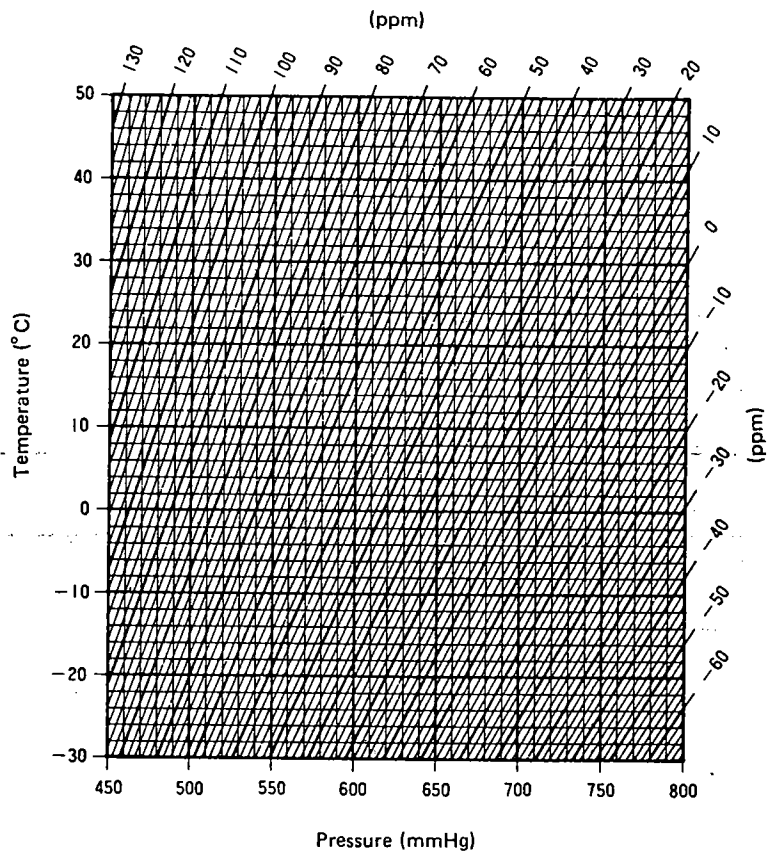

The table shows the correction every two ppm, while the atmospheric correction can be applied to the SDM3E for every ppm.

The specifications and general appearance of the instrument may be altered or improved at any time and may differ from those appearing in catalogues and operation manual.

MEMO

A series of horizontal dotted lines provided for writing the memo.

MEMO

A series of horizontal dotted lines for writing, spanning the width of the page.