

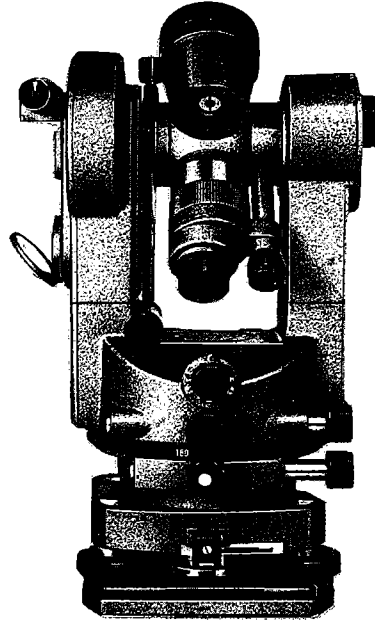

DOUBLE CENTER THEODOLITE TM-20C



**INSTRUCTION
MANUAL**



THE LIETZ COMPANY

1645 E. Del Amo Blvd. Carson, Ca. 90746 • (213)537-0410

INSTRUMENT NOMENCLATURE

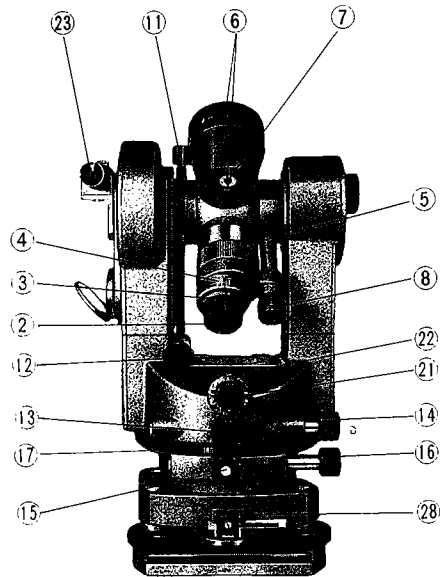

- ① Telescope objective lens
- ② Telescope eyepiece
- ③ Reticle focus ring
- ④ Reticle adjustment cover
- ⑤ Telescope focus ring
- ⑥ Pointer sights
- ⑦ Reticle illumination adjust knob
- ⑧ Microscope eyepiece
- ⑨ Micrometer knob
- ⑩ Light reflector
- ⑪ Telescope clamp
- ⑫ Telescope fine adjust screw
- ⑬ Upper motion clamp
- ⑭ Upper motion fine adjust screw

- ⑮ Lower motion clamp
- ⑯ Lower motion fine adjust screw
- ⑰ Circle positioning ring
- ⑱ Plate level
- ⑲ Plate level adjust screw
- ⑳ Circular level vial
- ㉑ Optical plummet
- ㉒ Optical plummet adjust screw
- ㉓ Compass
- ㉔ Compass pointer clamp
- ㉕ Tribrach
- ㉖ Leveling screw
- ㉗ Bottom plate
- ㉘ Tribrach clamp & set screw

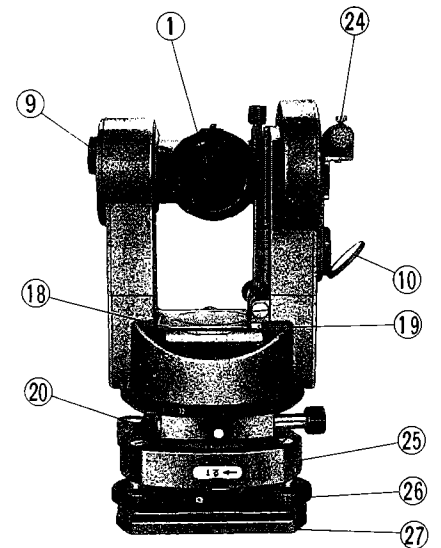

DOUBLE CENTER THEODOLITE TM-20C

The TM-20C Theodolite has a remarkably accurate optical system. Ultra-fine graduations on glass are carried optically to the reading microscope located adjacent to the telescope eyepiece thus allowing for precision and speed of readings. Both horizontal and vertical circles are viewed at the same time. The micrometer window separates the horizontal and vertical windows to minimize possibility of error and simplify reading angles.

The sum of the circle reading and micrometer reading are displayed directly to 20 seconds and by estimation to 5 seconds. The horizontal angle reading is the mean of graduations on opposite sides of the circle, thus eliminating any eccentricity error in the circle.

The vertical circle is automatically indexed thus eliminating the need for a level vial on the standards.

A small illumination battery pack, as standard equipment, attaches quickly to the instrument when poor lighting conditions prevail.

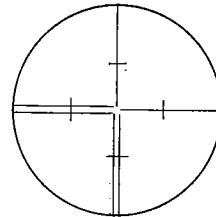
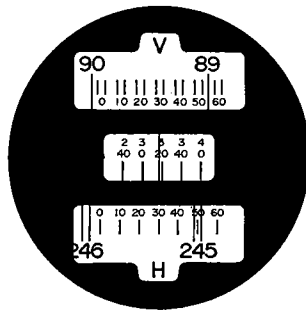

Reticle supplied

$$\begin{array}{r} \text{H} \quad 245^{\circ} 50' \\ + \quad \quad 3' 18'' \\ \hline 245^{\circ} 53' 18'' \end{array}$$

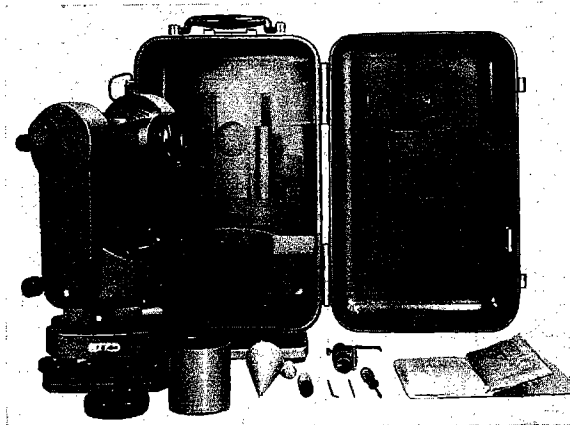
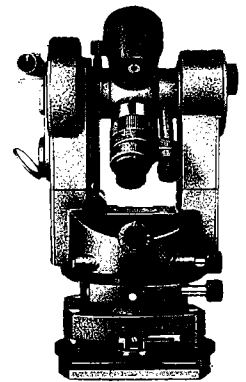

Telescope:

6.9 inch (175mm), achromatic; internal focusing with straight cut rack and pinion. Erect image, reversible in both directions and balanced on axis. 28× magnification resolving to 3 seconds of arc. Minimum focus $4\frac{1}{4}$ feet (1.3m.). Objective aperture 1.6 inch (40mm.). Field of view 1 degree 20 minutes (233 feet at 1000 feet). Bronze telescope axis with cylindrical bearings. All lens surfaces coated except first and last.

Reticle:

Glass, etched (type D), stadia ratio 1 : 100. Constant is 0. Stadia lines are short to distinguish them from cross hairs.

Horizontal Circle:

3.15 inch (80mm.) diameter glass circle graduated to 1 degree. Micrometer scale reads direct to 20 seconds, with estimation to 5 seconds. Circle is numbered 0-360 degrees and can be positioned to any desired angle by means of an external graduated ring.

Vertical Circle:

2.75 inch (70mm.) diameter glass circle graduated to 1 degree. Micrometer scale reads direct to 20 seconds, with estimation to 5 seconds. Circle is numbered 0-360 degrees with 0 at zenith, 90 degrees and 270 degrees at horizontal position. Automatic vertical circle indexing with range ± 5 minutes.

Optical Reading System:

Both horizontal and vertical circle readings are carried through a completely enclosed system of prisms and lenses to a reading micrometer located adjacent to the eyepiece of the telescope. Both circle readings and the micrometer scale are viewed simultaneously.

Level Vials:

Sensitivity of plate level vial 40 seconds per 2mm. Sensitivity of circular level vial 10 minutes per 2mm.

Optical Plummet:

Crosshair target reticle located in the alidade so that it rotates with the instrument. Erect image—Focusing range 21'' to 50 feet.

Instrument Base:

Detachable tribrach with $\frac{3}{8}\times 11$ thread. Instrument is secured to tribrach by swivel clamp. Dust protected leveling screws. Built-in circular level on tribrach.

Centers:

Hardened steel cylindrical centers with thrust bearings.

Finish:

Gray enamel.

Equipment:

Hermetically sealed steel carrying case complete with plumb bob, trough compass, night illumination battery pack, adjusting pin, dust cap, dust brush, sunshade, plastic rain hood.

Weight:

Instrument only—11 lbs. Case only— $8\frac{1}{4}$ lbs.

Shipping weight—25 lbs.

CROSS SECTION VIEW TM-20C
SHOWING LIGHT PATH

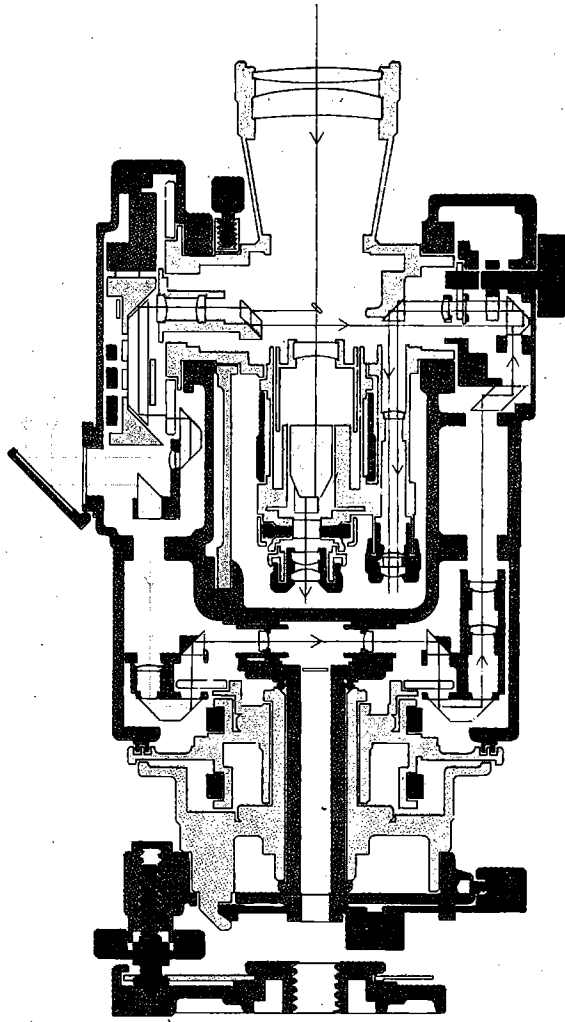

FEATURES OF THE TM-20 C

DIRECT READING MICROMETER SYSTEM

Horizontal circle, vertical and micro scales are within the same field of view. With the microscale the horizontal and vertical circles can be read directly to 20 seconds and by estimation to 5 seconds.

AUTOMATIC VERTICAL CIRCLE COMPENSATOR

With the automatic vertical circle compensator, vertical angles can be measured accurately with the theodolite approximately horizontal. The automatic compensator is the same as that used in an automatic level. It automatically indexes the vertical circle by a pendulum system to a true vertical axis (the direction of gravity)—thus providing good accuracy even in locations where temperature changes rapidly or vibrations occur.

OPTICAL PLUMMET

With the optical plummet, the theodolite can be set up quickly regardless of wind conditions or vibrations—thereby greatly reducing the time required to plumb the instrument. The optical plummet is located in the alidade so that it rotates with the instrument and provides an erect image with a focussing range of 21" to 50 feet.

DETACHABLE TRIBRACH

The TM-20 C Theodolite can be mounted and removed from its leveling base. Thus, precise traverse surveys can be made by use of an optical target which can be installed in the tribrach. The tribrach will also fit subtense bars as used for accurate measurement of distance.

NIGHT ILLUMINATION BATTERY PACK

The telescope reticles and micro-circle scales can be clearly seen and read by installing the illumination attachment in a position above the light reflector.

HORIZONTAL CIRCLE POSITIONING RING

To facilitate the speed and ease of turning horizontal angles the TM-20 C Theodolite is equipped with an external horizontal circle positioning ring. It is boldly marked at the quadrant points, ie. $0-90^{\circ}-180^{\circ}-270^{\circ}$, and is knurled for ease of location and manipulation while viewing the reading micrometer.

OPTIONAL ADDITIONAL ACCESSORIES AVAILABLE

CIRCULAR COMPASS

The circular compass is fitted with an easy reading prism and designed to fit into the bracket which supports the standard accessory trough compass. It positions above the telescope with sufficient room to allow transiting of the telescope.

DIAGONAL EYEPIECE PRISM

Measurement of vertical angles near zenith, and astronomical observations can be made

made by replacing the regular eyepiece cap with this diagonal eyepiece. Prism delivers the image at a 90° angle to the line of sight of the telescope.

RIGHT ANGLE (ZENITH) PRISM

Delivers image at a 90° angle to line of sight telescope. Replaces regular eyepiece cap. Extra length enables full zenith cross hair observation. Set of two prisms (one for telescope eyepiece - one for microscope eyepiece). Complete with case.

SETTING UP THE THEODOLITE

- (1) First, set up the tripod, spreading the legs so that they form a regular tetrahedron. (see Fig.1)
- (2) Firmly set tripod shoes into the ground in such position that the tripod head is located as near as possible above the point. The tripod head should be kept as level as possible and wing nuts (if any) tightened.
- (3) Remove the theodolite from its case and set it on tripod head. Screw the mounting bolt of the tripod head into the female thread in the bottom of tribrach base. (see Fig. 2)
- (4) Level the theodolite while observing the circular level vial on the tribrach base. When the bubble is in the center of the circular level vial the instrument is approximately level.
- (5) Next, level the instrument by means of the plate level vial. Place level vial in position parallel to leveling screws B and C. (see Fig. 3) Adjust position the bubble using leveling screws "B" and "C". Now, turn the instrument 90°, adjust level with levelling screw "A"

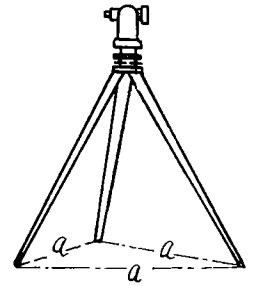

FIG. 1

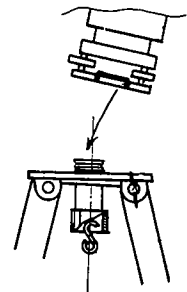

FIG. 2

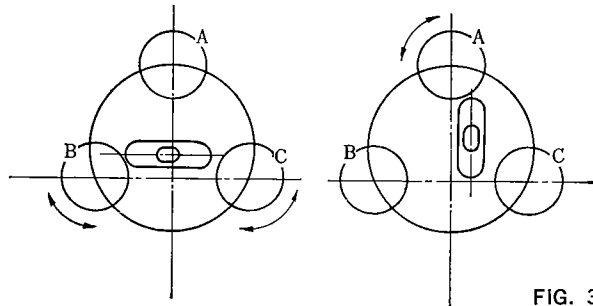

FIG. 3

- (6) Set the instrument on the point accurately by observing the point through the optical plummet. By slightly loosening the mounting bolt. (Fig. 2) the instrument may be shifted so to center the optical plummet reticle on to the point. If necessary, the leveling procedure in (5) may have to be repeated.
- (7) When the instrument is level and all vertical alignment is correct the optical reticle center will remain on the point throughout a 360° rotation of the instrument.

READING THE MICRO-SCALES

Looking at Figure 4, two sets of parallel lines, 0° and 359°, are seen in the H window. These parallel lines (at each degree mark) represent the actual graduations on opposite sides of the horizontal circle. One full degree is divided equally into six 10 minute divisions on the fixed reference index scale (0 to 60). Note that when the two lines for 0° are bisected by the graduation on the index scale, the two lines for 359° are also bisected by the 60 minute graduation. Thus an angle can be read directly to 10 minutes in this window. (The vertical circle (V window) is read in a similar manner).

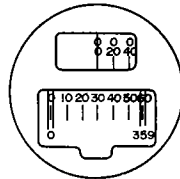

FIG. 4

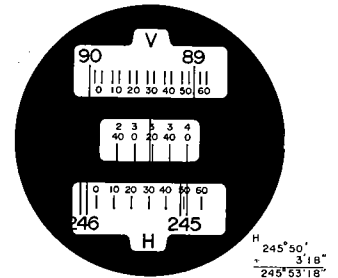

FIG. 5

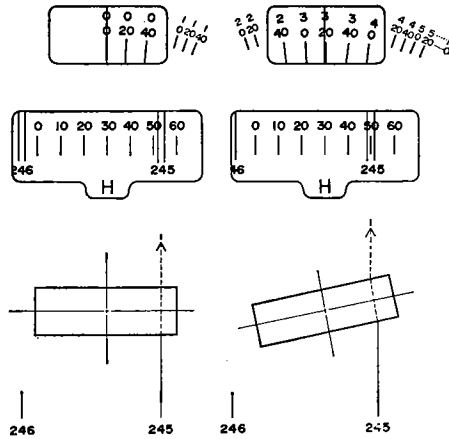
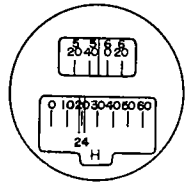
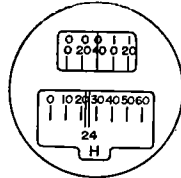
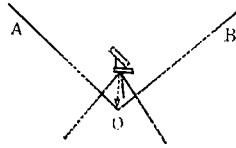

FIG. 6

Shown in Figure 5 is a typical view through the microscope eyepiece with an observed reading of 245°-53'-18". Figure 6 shows how this angle (245°-53'-18") is obtained. To the left of Fig. 6, the H window and micrometer scales are shown as a point is sighted. Note that both the 245° and 246° graduations are seen and that the 245° graduation is between the 50' and 60' fixed index lines. This indicates that the reading will be between 245°-50' and 246°-00'. Next the micro-knob is turned, tilting the

parallel flat glass (see the right side of Fig.6). This moves the image of the graduation only—and not the circle. Now the parallel 245° lines are bisected by the 50 minute line on the fixed index scale—and the additional increment reading of 3'–18" is read on the micrometer scale for a final angle of 245°–53'–18".



24° 25' 50"

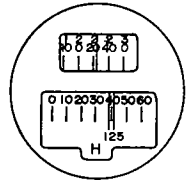
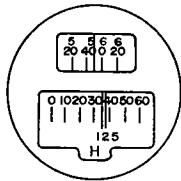
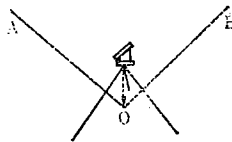

125° 42' 26"

FIG. 7

TURNING HORIZONTAL ANGLES

I. Reading an Angle Clockwise (see Figure 7)

- Set up the instrument, sight on point "A" and clamp—using the lower motion clamp fine adjusting screw.
- Look into the micro-eyepiece, turn the micro-knob to position two lines of a degree graduation on the horizontal circle so that they are bisected by one of the fixed index line graduations. We now read 24°–25'–50" at Point "A"
- Using the upper motion clamp and fine adjusting screw we next sight at Point "B".
- Again, positioning the parallel lines of a horizontal circle graduation so that they are bisected by one index line, we read 125°–42'–26" at Point "B".
- Thus the reading at Point "B" minus the initial reading at Point "A"

$$\left(\begin{array}{l} 125^\circ - 42' - 26'' \\ 24^\circ - 25' - 50'' \end{array} \right) \text{equals } \angle AOB.$$

$$\angle AOB = 101^\circ - 16' - 36''$$

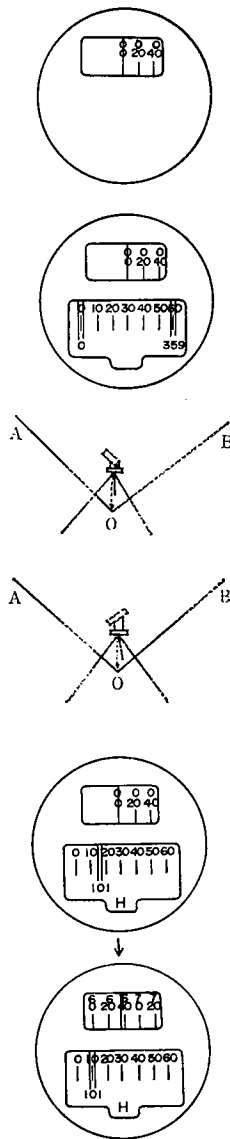

FIG. 8

II. Reading an Angle Clockwise from Zero Setting (see Fig. 8)

- Set up the instrument and set the micro-scale to zero.
- Loosen the upper motion clamp and set the horizontal circle to zero.
- Loosen the lower motion clamp, sight on Point "A", tighten clamp and perfect alignment with fine motion screw.
- Now loosen upper motion and after sighting on Point "B", tighten clamp and use fine adjusting screw.
- The angle has now been turned and we read the resultant \angle using the micro-knob and method previously explained. $\angle AOB = 101^{\circ}-16'-36''$

III. Laying Out of a Predetermined Angle

- Set up the instrument and set scales to zero on both the micro-scale and the horizontal circle and clamp upper motion.
- Keep upper motion clamped and sight on Point "A" with lower motion clamp and fine adjustment screw.
- Now loosen upper motion clamp and turn off a predetermined angle (clockwise) example $\angle AOB = 101^{\circ}-16'-36''$ as follows:
 - Turn the micro-knob and set the micro-scale to read $6'-36''$
 - Next loosen upper motion, turn telescope clockwise and set $101^{\circ}-10'$ on the H scale and clamp upper motion.
 - Now sight upon and establish Point "B" as a point $101^{\circ}-16'-36''$ from backsight "A" = $\angle AOB$.

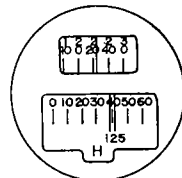
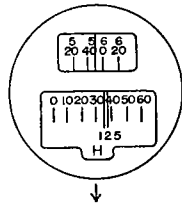
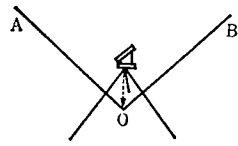

125°42'26"

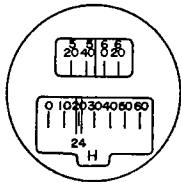
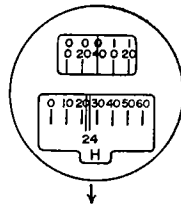
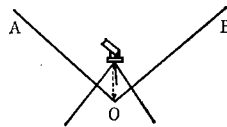

24°25'50"

FIG. 9

IV. Reading an Angle (Counterclockwise)

see Figure 9

- (1) Clamp lower motion, loosen upper motion, point telescope at Point "B", clamp upper motion and use fine adjustment screw.
- (2) Turn the micro-knob and read 125°-42'-26".
- (3) Loosen upper motion clamp and sight on Point "A". Tighten upper motion clamp and complete setting with fine motion screw.
- (4) Turn the micro-knob to complete the reading of 24°-25'-50".
- (5) Subtract $\left(\begin{array}{r} 125^{\circ}-42'-26'' \\ 24^{\circ}-25'-50'' \\ \hline 101^{\circ}-16'-36'' \end{array} \right)$ to obtain \angle BOA.
- (6) If reading at Point "A" is greater than reading at Point "B", add 360° to the angle at Point "B" before computing the resultant angle.

VERTICAL CIRCLE

The vertical circle is read in the V window (through the micrometer eyepiece) in the same manner as the horizontal circle. There is only one graduation at each degree mark as compared to two graduations to each degree mark on the horizontal circle. As previously explained, since both sides of the horizontal circle are read by the optical light path—two graduation lines are seen. Only one side of the vertical circle is read—hence only one graduation line is seen at each degree mark.

In addition, to supplement the single line graduations of the vertical circle scale, the 10 minute graduations on the V fixed index scale are indicated by **Parallel** lines.

This enables the instrument man to use the micro-knob as explained on p. 7 for the H scale. The difference being only that, in this case, the 10 minute parallel graduations are bisected by the single

degree graduation.

The vertical circle is installed in the instrument so as to read 90° when the telescope is in a horizontal position and 270° when it is in the plunged horizontal position.

The Model TM-20 C Theodolite is equipped with an automatic vertical circle compensator which automatically indexes the circle to the direction of gravity despite temperature changes and vibration. The compensator has a range of ± 5 minutes of arc, therefore the instrument must be set level to within this range in order that the automatic indexing feature will function.

INSPECTION, CARE AND MINOR ADJUSTMENTS

Undue vibration, during transportation or operation, and extreme heat changes can adversely affect the accuracy of the instrument.

Before and during use, the instrument should be inspected periodically to assure that it is in good working order—and minor adjustments should be made, if required, providing those adjustments can be made in the field.

Please bear in mind that the TM-20 C Theodolite is a precise instrument and adjustments should be made in sequence. Thus, when adjusting, do not attempt to adjust completely in one step. It is recommended that you repeat adjustments and proceed in a sequence which will provide a broad base of accuracy.

ADJUSTMENT PROCEDURES

- I. Right angle alignment of the plate level vial compared to the vertical axis.
- II. Right angle alignment of the telescope reticle (vertical line) compared to the horizontal axis.
- III. (A) Correct alignment of vertical reticle line
(B) Correct alignment of horizontal reticle line
- IV. Coincidence of optical plummet axis with vertical axis

I. RIGHT ANGLE ALIGNMENT OF PLATE LEVEL VIAL TO VERTICAL AXIS

The level vial tube, being made of glass, can be affected by temperature fluctuation or shock. Be sure to inspect the plate level before using the instrument.

ADJUSTMENT METHOD:

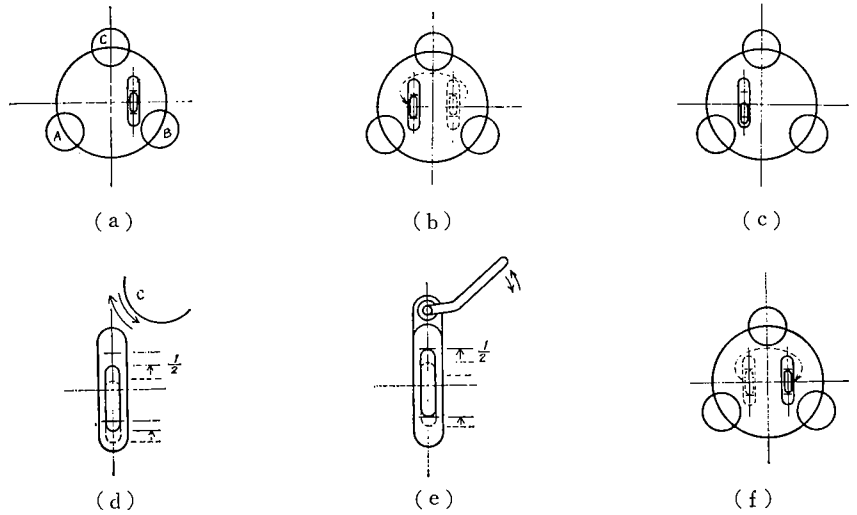

- (a) Align the plate level vial 90° to one pair of leveling screws and center the bubble.
- (b) Turn the instrument 180° and make sure the bubble is in the center of the vial.
- (c) When the bubble does not center, further adjustment is required.
- (d) Adjust half of the error with leveling screw.
- (e) Adjust remaining half of the error with adjusting pin so that the bubble is in the center.
- (f) When the bubble is centered, turn instrument 180° and repeat adjustment. Bubble should remain in center of vial when the instrument is rotated.

II. RIGHT ANGLE ALIGNMENT OF TELESCOPE RETICLE (VERTICAL LINE) COMPARED TO HORIZONTAL AXIS

INSPECTION AND ADJUSTMENT PROCEDURE:

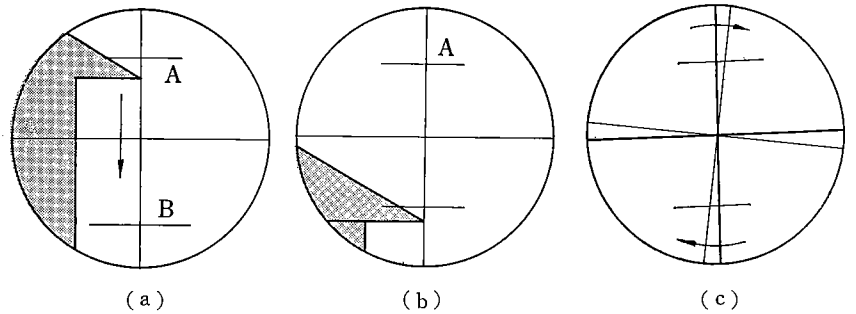

- (a) Sight on clearly observed point (such as edge of roof) to "A" on the upper part of vertical line of reticle.

- (b) Turn the telescope fine adjust screw slowly and move the telescope so that the observed point is now seen at "B".
- (c) If the observed point does not move parallel to the vertical line, slightly rotate the reticle frame. Adjusting screws are located by unscrewing reticle adjustment cover.

III A. ADJUSTING VERTICAL RETICLE LINE

This correction is required to measure horizontal angles correctly. Inspection and adjustment can be made easily in the field by using a small target affixed to a building or telephone pole at a distance of approximately 150 feet (45 meters) from the instrument and a scale approx. 12" (30cm) long should be set at the same distance from the instrument and 180° from the target.

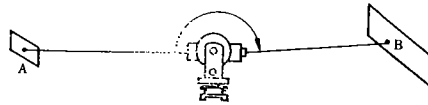

(a)

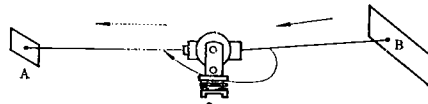

(b)

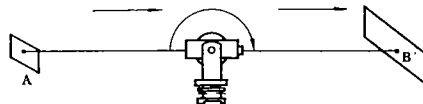

(c)

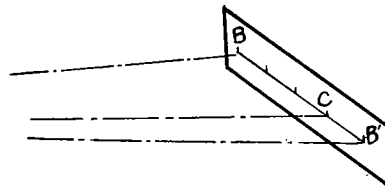

(d)

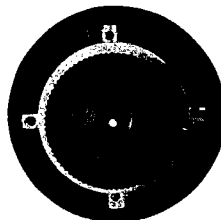

(e)

INSPECTION:

- (a) With the instrument positioned midway between the scale and the target, take a back sight at the target "A" and clamp. Next, loosen the telescope clamp screw, plunge the telescope 180° and observe the point at which the vertical reticle line intersects the scale "B"
- (b) Next, loosen the upper motion clamp, rotate the telescope 180° toward Point "A" and sight and clamp on Point "A"
- (c) Now, loosen the telescope clamping screw, plunge the telescope 180°, focus on scale and observe Point B'. Make sure that the point B and Point B' coincide. If they do, the alignment is correct.

ADJUSTMENT:

- (d) When the points B and B' do not coincide, adjust position of vertical reticle line to Point C on the line between points B and B'. The distance from Point B' to Point C equals 1/4 of the distance between points B and B'
- (e) Remove the reticle adjustment cover on the eye-piece unit thus making the reticle adjusting screws accessible. Adjust two screws (right and left screws) with adjusting pin so that center of the reticle is on Point C measured from B'. Repeat the above adjustment if necessary.

III B. ADJUSTING HORIZONTAL RETICLE LINE

INSPECTION:

Set up the instrument and level it. Set the vertical circle to 90° and the micrometer to zero. Hold a level rod at a distance of approx. 75' (25m) to 125' (40m) from the instrument and read the rod "a1".

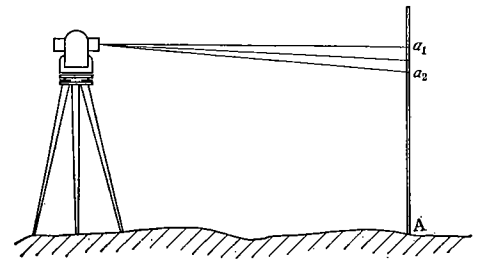

Next, rotate telescope 180° and plunge 180° , set the micrometer to zero and the vertical circle at 270° . Sight on same level rod and observe whether previous reading "a1" coincides with the new reading "a2". If not, adjustment is necessary.

ADJUSTMENT: When "a1" does not coincide with "a2", adjust the horizontal reticle to a position between a1 and a2. Turn upper and lower adjusting screws with adjusting pin until the horizontal reticle is aligned correctly.

IV. ALIGNMENT OF OPTICAL PLUMMET AXIS COMPARED TO VERTICAL AXIS

INSPECTION:

In order to set the instrument over a point correctly, check to be sure that the optical plummet axis is in alignment with the vertical axis.

Set the instrument level, observe the point through the optical plummet and set plummet reticle on the point accurately. Loosen the lower clamp screw, turn the instrument 90° around the vertical axis and observe the point through the optical plummet again. If the center has not moved, the optical plummet axis is in alignment with the vertical axis. If adjustment is necessary, proceed as follows:

ADJUSTMENT: The optical plummet eyepiece is provided with a set of adjusting screws. When the instrument is turned 180° and the optical plummet axis is moved from the point, turn adjusting screws so that a half of the movement is corrected. Repeat this adjustment until the center always remains on the point when the instrument is turned 360° on its vertical axis.

PRECAUTIONS FOR HANDLING INSTRUMENTS

- (1) Be sure to carry the instrument in its case whenever transporting between job sites, etc
- (2) Whenever carrying the instrument set up on the tripod do not carry it over your shoulder but preferably cradled in an "under-arm" position. Above all, the instrument should never be lifted for carrying until a security check is made on all fasteners, especially tribrach clamp and tripod head mounting bolt.

- (3) When setting up the instrument be sure to spread the tripod legs sufficiently so that the instrument is properly braced against possible fall.
- (4) Particular care should be taken not to grasp any part which may put the instrument out of adjustment such as the telescope, level vial, etc.
- (5) When leaving the instrument set up for a long period of time, be sure to cover the instrument with plastic instrument hood.
- (6) Avoid exposure of the instrument to rain. If the instrument is subjected to moisture, thoroughly wipe with a dry cloth before returning it to its case. Excessively damp areas may require frequent use of a drying agent material in storage case.
- (7) Upon completion of a survey, clean the instrument before retuning it to its case. Clean the lens carefully with a soft hair brush or lens tissue. When dust cannot be removed by that method, use several drops of alcohol or ether on a piece of clean, lint free cloth and wipe the lens gently.
- (8) When returning the instrument to its case, be sure to tighten all set screws lightly. Also make sure that the instrument sets into case easily--**NEVER USE ANY FORCE**. Maintain a periodic inspection of the case latches for wear.
- (9) When transporting the instrument, it is recommended that it be carefully protected from shock with proper cushioning.
- (10) Periodically inspect all accessories.
- (11) When the tripod is used for a long period of time, the leg shoes may be loosened or wingnuts may be worn. Check them carefully before use.
- (12) Be sure to keep the instrument in a place free from moisture and vibration. A locker or shelf is recommended for storage. In no event should anything be put on the case.

PERIODICAL INSPECTION AND MAINTENANCE

- (1) The theodolite is a precise instrument. Particular attention should be given to deterioration and hardening of lubricant. Make sure that all components operate smoothly through periodic inspections; enlist the services of qualified instrument technicians for a periodic maintenance program of cleaning, lubrication and adjustment.
- (2) Should there be any signs of foreign matter in the moving or threaded parts of the instrument--or any signs of moisture on the lens or prism inside the instrument, contact your nearest qualified instrument repair facility immediately.